

GCX Mounting Assembly Installation Guide

Drager Narcomed GS Anesthesia Machines with Philips MP60/70 IntelliVue Patient Monitor Kit

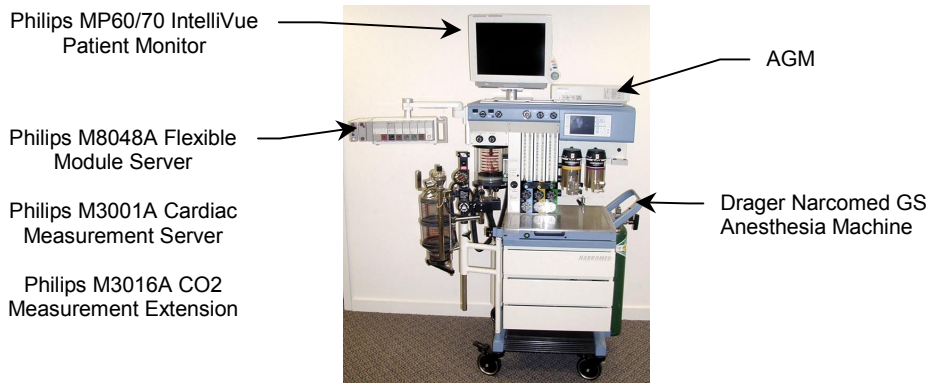

The purpose of these instructions is to:

1. Describe attachment of GCX mounting hardware for Philips MP60/70 IntelliVue Monitor Kit to the Drager Narcomed GS Anesthesia machine.



WARNING: USE OF MOUNTING HARDWARE AND MONITORING COMPONENTS OTHER THAN THOSE DESCRIBED IN THIS DOCUMENT MAY RESULT IN SERIOUS INJURY DUE TO TIPPING OF THE ANESTHESIA MACHINE.

GS Single Counterweight Kit

1. Place the (2) Spanning Rails on the lower horizontal members of the anesthesia machine. Insert the 5/16-18 x 3" hex bolts through the counterbored holes in the Rails, through the holes in the anesthesia machine, through the holes in the lower pan, and secure them with the (4) 5/16-18 keps nuts provided.

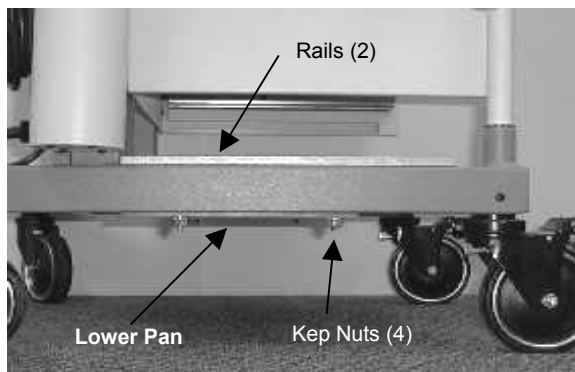

3. Insert the (2) weight bars into the lower pan. Fix them in place by running the (2) 5/16-18 x 2 1/2" or (2) 5/16-18 x 1 1/2" hex bolts through the fender washers and into the inserts in the lower pan.

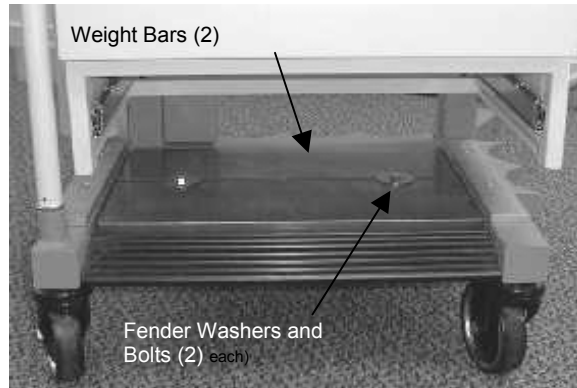

3. Attach the Cover to the top of the Rails, using the (4) #10-32 x 3/8" socket head cap screws.

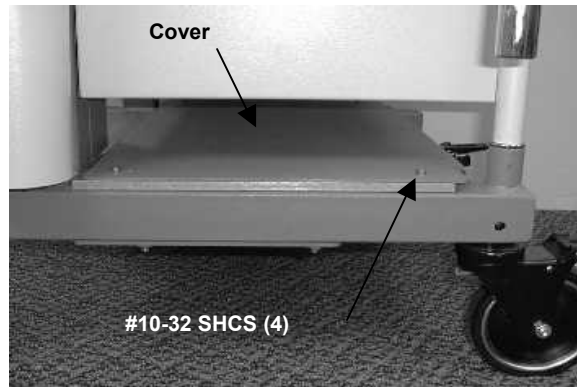

GS Secondary Counterweight Kit

1. Assembly is the same as above but insert a second pair of Weight Bars into the Lower Pan.

GS Top Plate with Cam Lock Rails

1. Place the painted top plate into the recess in the top of the anesthesia machine. Using the plate as a template, mark the top of the machine in the (6) locations indicated.

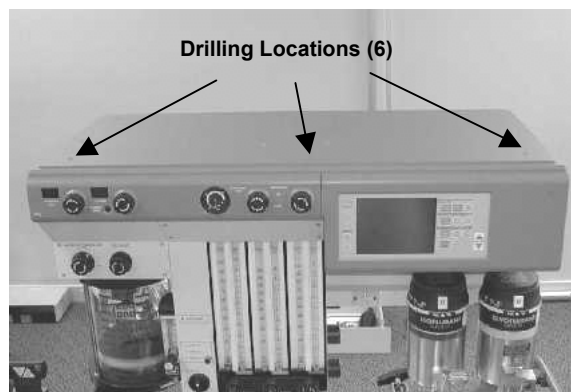

- Loosen the socket set screws (2 each side) to release the top of the machine. Lift up on the top of the machine and drill in the locations marked in step #1. Use a 1/4" diameter drill bit. Be careful not to drill too deeply, as damage to internal components of the machine could result. Remove all drilling chips.

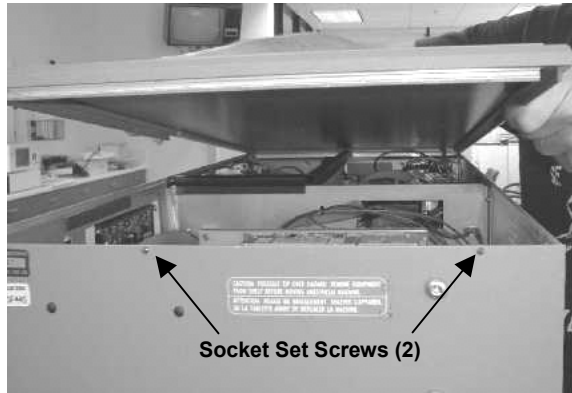

- Run the (6) #10-32 x 3/4" flat head machine screws through the top plate and into the holes drilled in step #2. Tighten the (6) #10-32 keps nuts onto the bottom of the screws. Reassemble the top of the anesthesia machine.

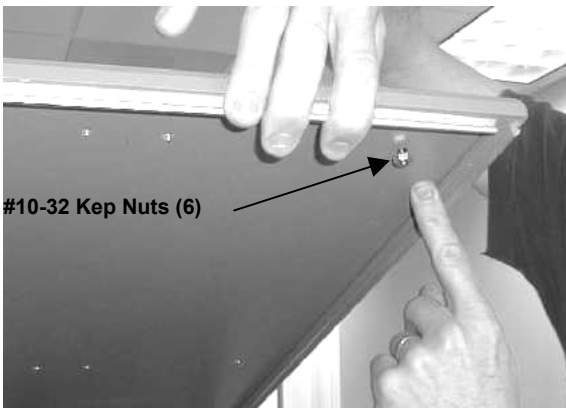

AGM Installation to the Top-Shelf Cam Lock Plate

- Insert the front edge of the AGM Feet to the front and rear Cam Lock Rails.



2. Secure the AGM to the Top-Shelf Plate by moving the AGM Cam Lock Lever as shown.

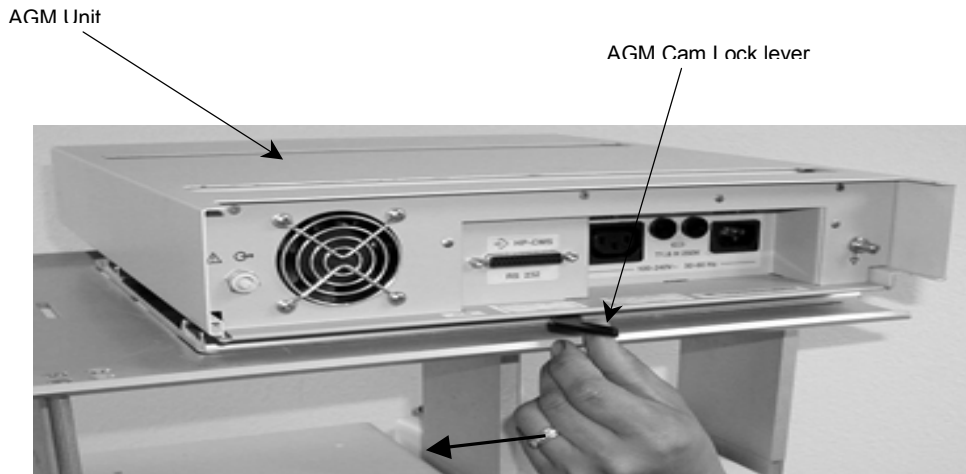

Camlock Mount to the Top Shelf

1. Engage the feet of the Subplate onto the Cam Lock Rails. Lock the Assembly by moving the Cam Lock Lever as shown. Secure the Subplate to the Cam Lock Rails by using the supplied M4 x 20mm PHMS (2) on the outside screw holes and the #6-32 X 3/8"PHMS (1) on the screw hole next to the Cam Lock Lever.



CAUTION: Due to the off center load, this assembly will tip if not secured properly. Check the engagement of the cam lock, lever, feet, and locking screws.

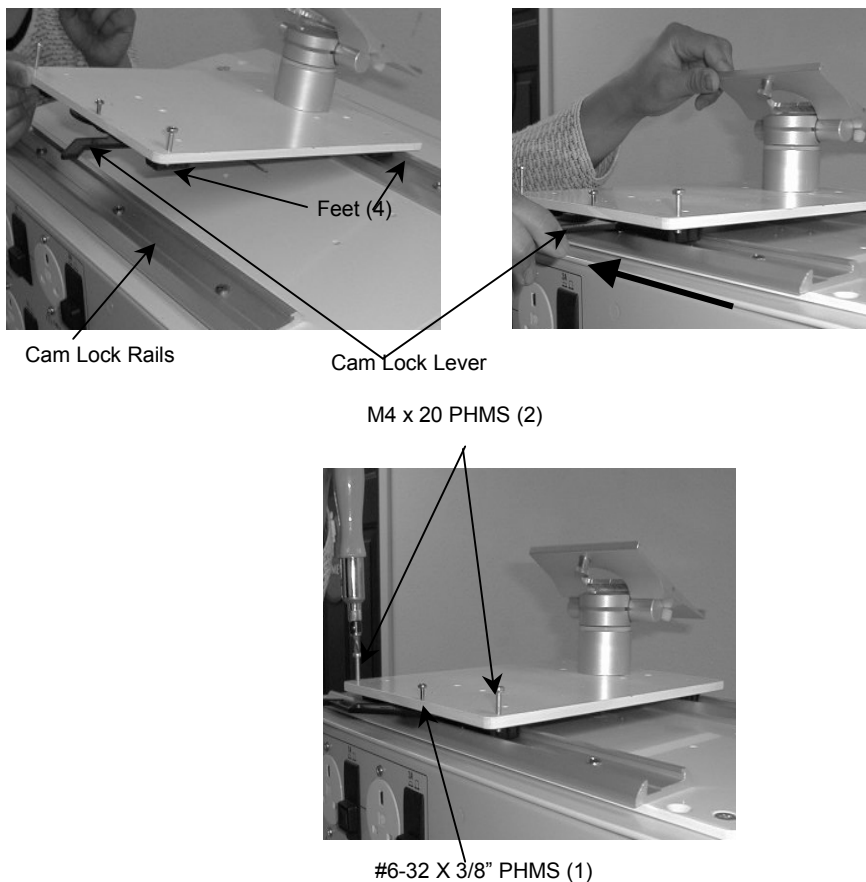

Attaching the Adaptor Plate

1. Place the monitor on a padded surface, and turn upside down, so the bottom of the device is facing upward. Remove the existing screws and replace them with the supplied 7/16 x 1/4 x 7/16 Bronze Bushings (2). Place the Adaptor Plate over the Bronze Bushings by lining up the 2-hole pattern.

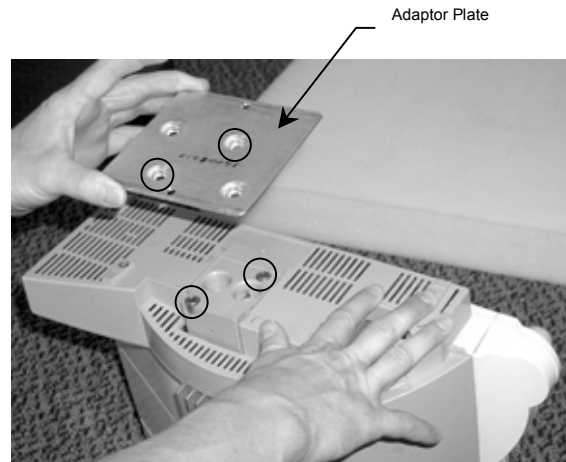
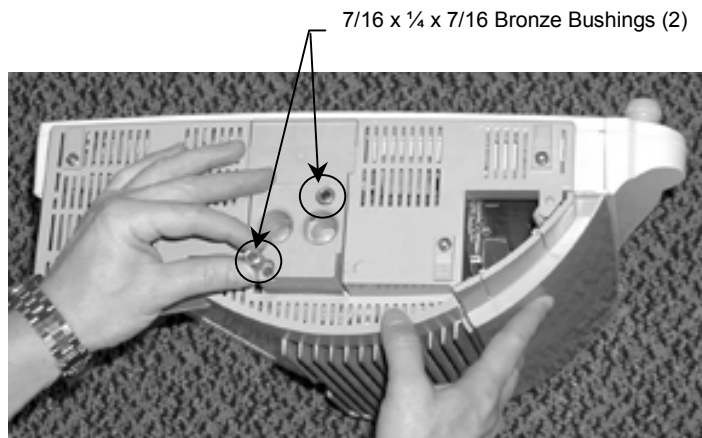

2. Secure the Adaptor Plate to the device by using the supplied M6 x 40mm FHMS (2).

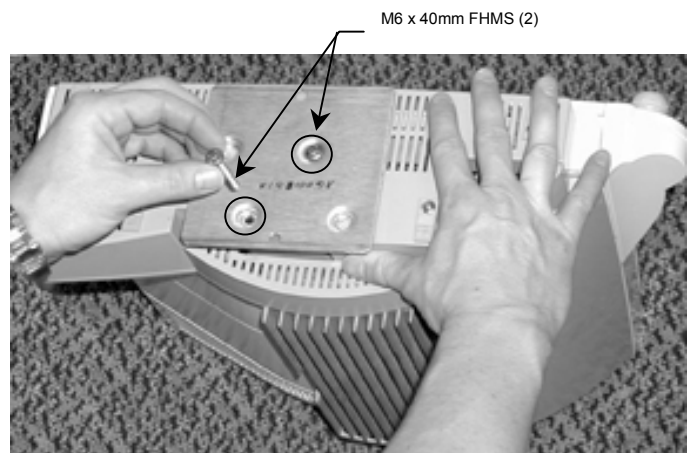
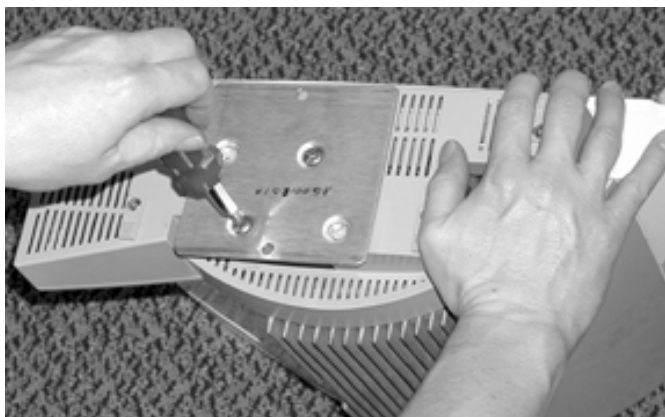

Attaching Philips MP60/70 IntelliVue Patient Monitor to Cam Lock Mount

1. Pull down on the Spring Plunger at the back of the Mounting Plate. Slide the device laterally into the Mounting Plate until the Plunger locates in the clearance hole at the back of the Mounting Adapter. Tighten the Nylon Locking Screws located on the underside of the Plate.

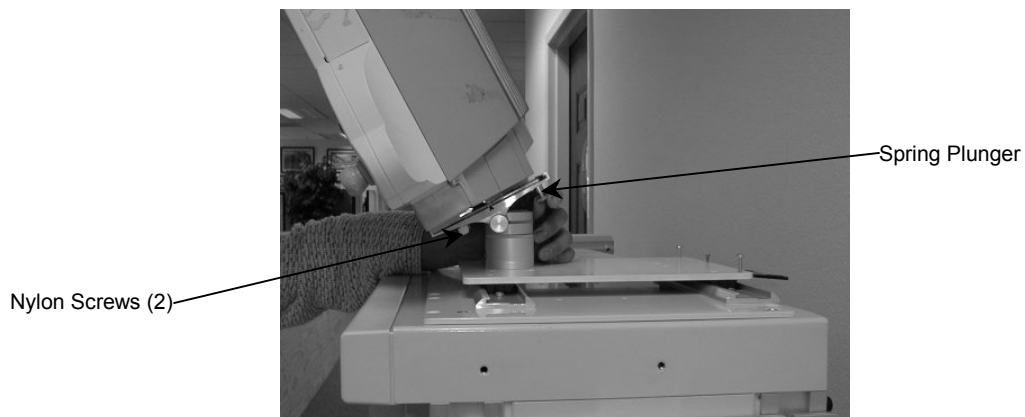

GS Side Channel Mounted to Left Side of the Machine

1. Locate the (2) 5/16-18 mounting holes in the left side of the upper portion of the anesthesia machine. Attach the Channel using the (2) 5/16-18 x 3/4" button head socket head cap screws included.

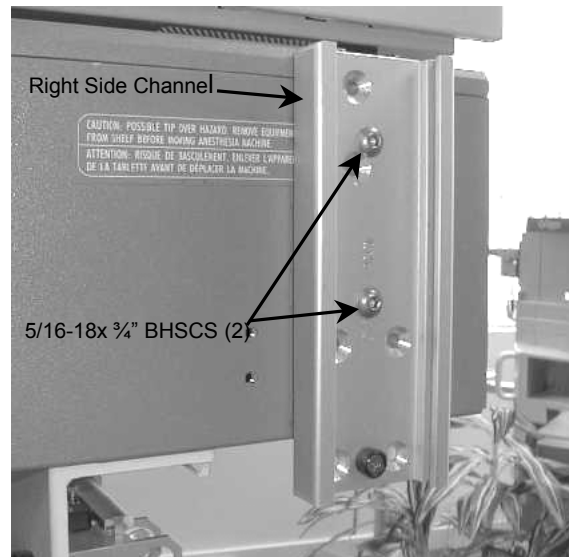
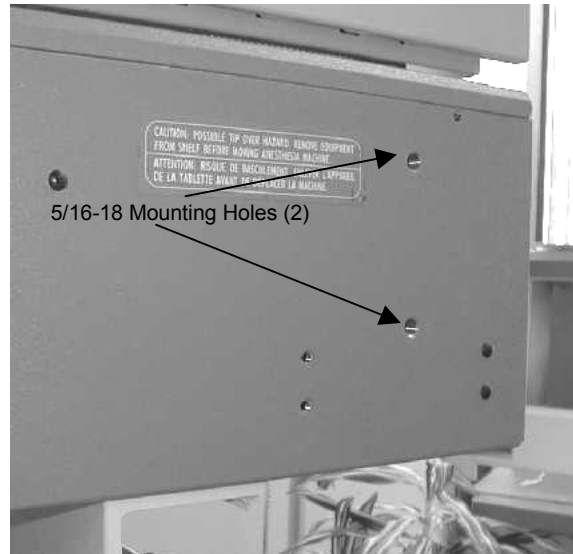

Flexible Module Server on M-Series Pivot Arm

1. Set the M-Series Pivot Arm with Down Post at the bottom of the Channel to provide space for the M-Series Pivot Arm holding the Philips Patient Monitor. Secure the Arm in the Channel by tightening the (2) $\frac{1}{4}$ -20 x $\frac{3}{4}$ " SSS in the Slide.



2. Align the screw holes in the Down Post with the threaded holes on the Swivel Fitting. Using the supplied $\frac{5}{32}$ (4 mm) hex key and secure the 10-32 x $\frac{3}{8}$ " SHCS (3).

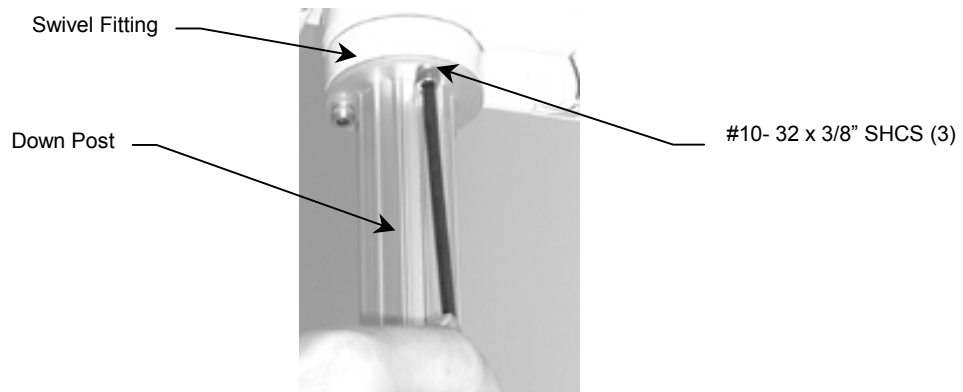

3. Attach the Flexible Module Server to the Down Post by placing the Clamp around the Down Post and tightening the knob.

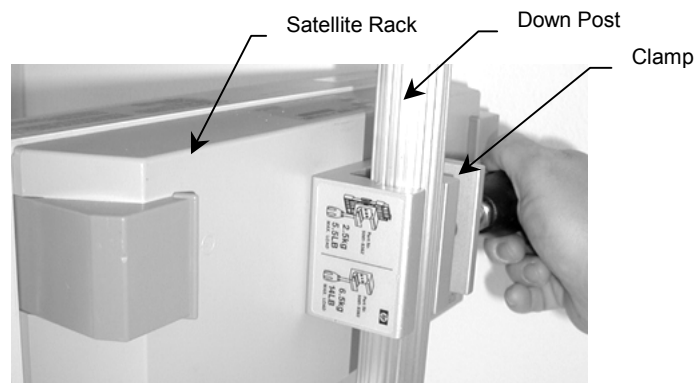

Adjustment and Operation of M Series Arm

Positioning in the Channel

WARNING: Never attempt to remove the mounting assembly from the Channel when loaded with a device.

1. Loosen the (2) $\frac{1}{4}$ -20 x $\frac{3}{4}$ " SHCS set screws in the Slide.
2. To raise or lower the Arm in the Channel, relieve the weight of the mounted device by lifting against the underside of the Arm, near the device. Simultaneously, push up or pull down the opposite end of the Arm just in front of the Slide.

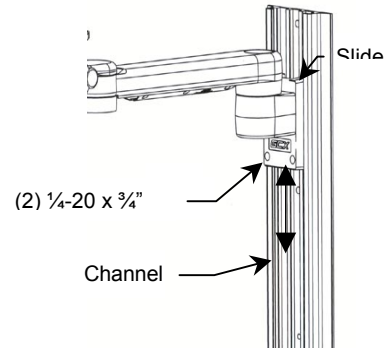

Pivot

1. To pivot at the Slide, simply push on the side of the Arm or mounted device.
2. To adjust the pivot tension at the Slide, use a $\frac{1}{2}$ " (or 13 mm) socket driver to tighten or loosen the Pivot Tension Bolt to obtain the desired tension.

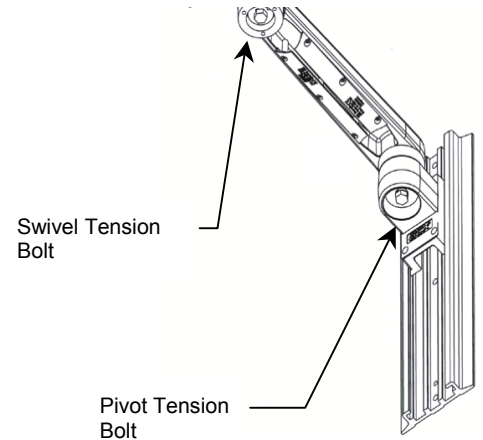

Swivel

1. In most configurations, the mounted device will swivel at the end of the Arm. To rotate the device simply push or pull the corners of the device.
2. To adjust the swivel tension, remove cap located under the front end of the Arm and use a $\frac{1}{2}$ " (or 13 mm) socket driver to tighten or loosen the Swivel Tension Bolt.



or

Cable Management

Two cable management features allow convenient placement and flow cables:

1. An open cavity beneath the arm with flexible cable covers manage cables going to and from the front and rear of the arm.
2. A "pass-through" channel slide allows cables to run behind the arm within the Channel. **Note:** If cable connectors are too large to fit through the pass-through, try placing the cables in the path of the Slide before installing the arm in the Channel. Contact GCX for optional Channel Covers available to further manage the flow of cables in the Channel.

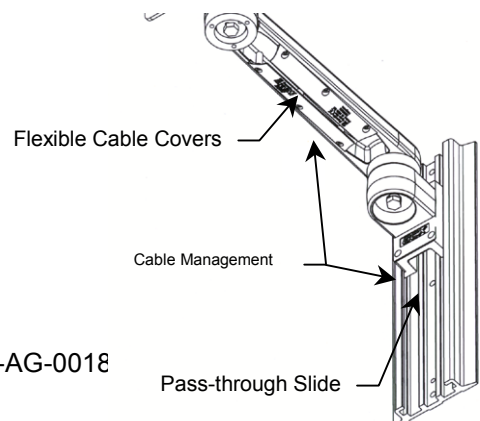

CLEANING

1. The mounting assembly may be cleaned with most mild, non-abrasive solutions commonly used in the hospital environment (e.g. diluted bleach, ammonia, or alcohol solutions).
2. The surface finish will be permanently damaged by strong chemicals and solvents such as acetone and trichloroethylene.
3. Steel wool or other abrasive material should *never* be used.
4. Damage caused by the use of unapproved substances or processes will not be warranted. It is recommended that you test any cleaning solution on a small area of the arm that is not visible, to verify compatibility.
5. Never submerge the arm, and do not allow liquids to enter the arm. Wipe any cleaning agents off of the arm immediately, using a water-dampened cloth. Dry the arm thoroughly after cleaning.

CAUTION: GCX makes no claims regarding the efficacy of the listed chemicals or processes as a means for controlling infection. Consult your hospital's infection control officer or epidemiologist. To clean or sterilize mounted devices or accessory equipment, refer to the specific instructions delivered with those products.