

GCX Mounting Assembly Installation Guide
 Datex-Ohmeda Aestiva –Display Arm Mounting Kit
 for Philips MX800 and MP60/70



The purpose of this guide is to:

1. Describe mounting of 7" Channel.
2. Describe mounting of Counterweight.
3. Describe attachment of table top mount to Mounting Bracket.
4. Describe attachment of Mounting Bracket to model 7100 ventilator display.
5. Describe attachment of Mounting Bracket to model 7900 ventilator display.
6. Describe attachment of Boom Arm Down Post or Side Post Assembly.



CAUTION: The Counterweight must be mounted on the anesthesia before mounting the MP60/70 and related instruments. For this application the Counterweight will be mounted on the right side of the machine. Attachment of the 7" Channel Assembly is required for mounting the Counterweight.

Mounting the 7" Channel

Parts Reference

The following parts and hardware will be used in this installation (see photo for parts, hardware not shown):

Item #	Description	Qty
1	Channel, 7" for Dovetail Track	1
2	Dovetail Runner	2
3	#10-32 X 7/16" Pan Head Machine Screw (PHMS)	4
4	#10 Flat Washer	4



7" Channel



Dovetail Runners (2)

Tools Required for This Task: Phillips screwdriver.

1. Thread one (1) #10-32 x 7/16" PHMS (with #10 flat washer) into one end of each Dovetail Runner, leaving 6mm of thread exposed between washer and Runner. These Runners will be inserted behind the Channel in step 3.

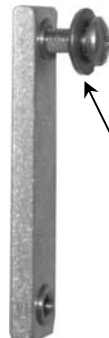

#10-32 x 7/16" PHMS (2)
 #10 Flat Washer (2)

From Left to Right in Illustrations Below:

2. Insert Channel Assembly (Fixed Stop downward) into rear track and slide as far as possible to right side of the track.
3. While holding Assembly in position, insert upper and lower Dovetail Runners in track (behind Channel), ensuring that screws slide into slots and washers are positioned on same side as screw heads.
4. Thread two (2) #10-32 x 7/16" PHMS (with #10 washers) into the remaining threaded holes in the Dovetail Runners.

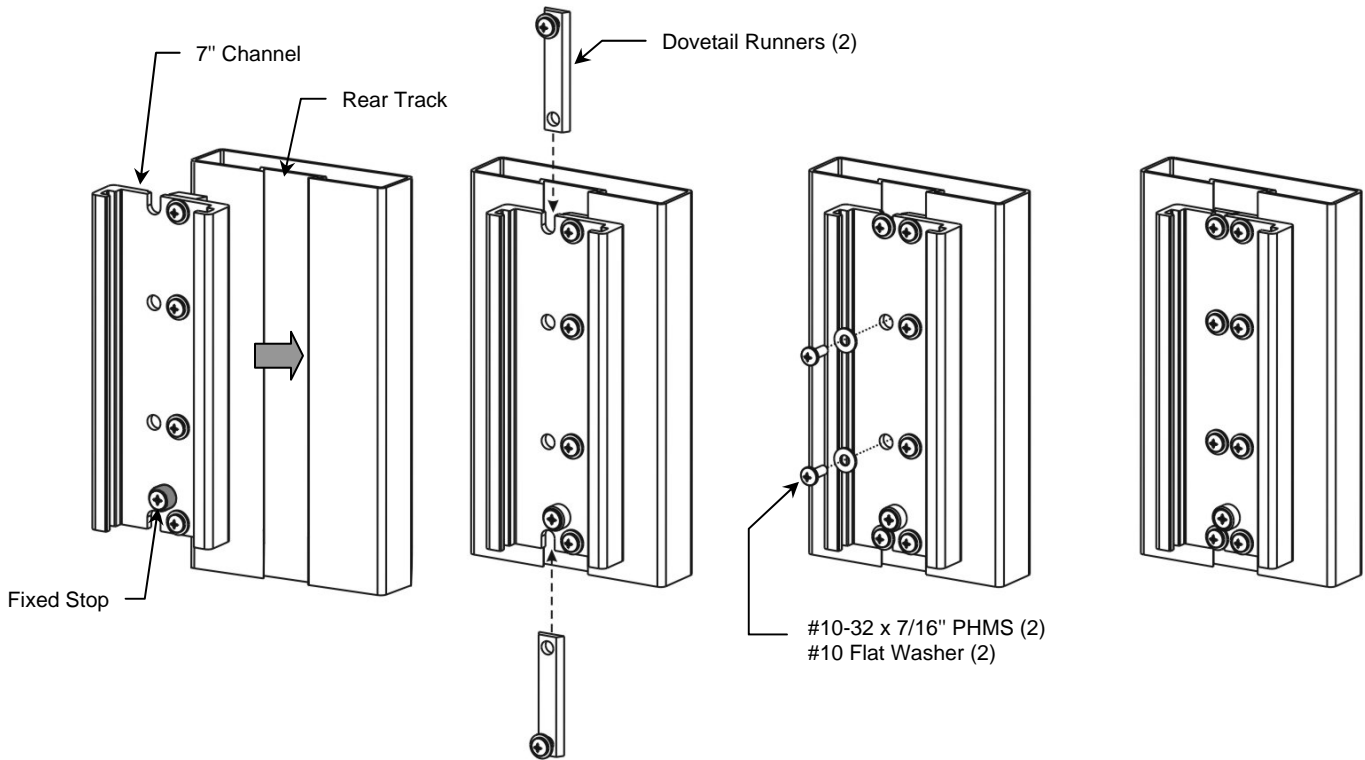

5. Position the bottom of Channel 1.25" above the base of the machine or existing counterweight (see photo). Tighten all eight (8) screws in the 7" Channel.

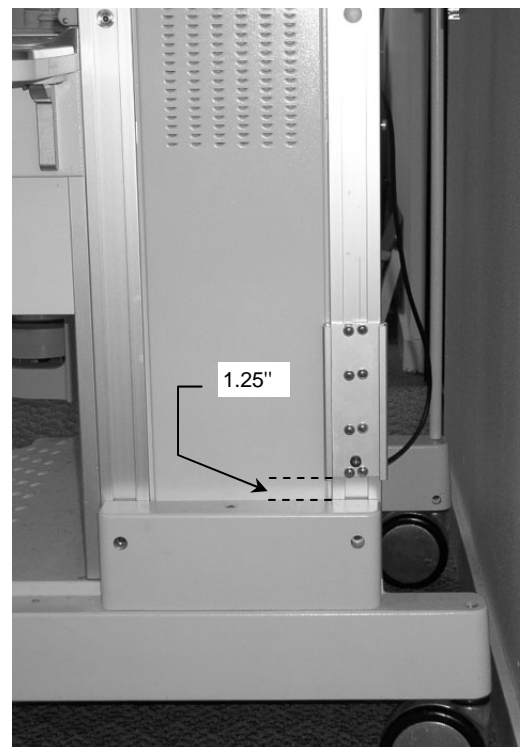

Mounting the Counterweight

Parts Reference

The following parts and hardware will be used in this installation (see photo for parts, hardware not shown):

Item #	Description	Qty
1	Weight Bar	1
2	Mounting Bracket	1
3	#10-32 x 1/4" Flat Head Machine Screw (FHMS), 100°	4
4	Counterweight Cover	1
5	Slide	1
6	#10-32 x 5/8" Pan Head Machine Screw (PHMS)	4

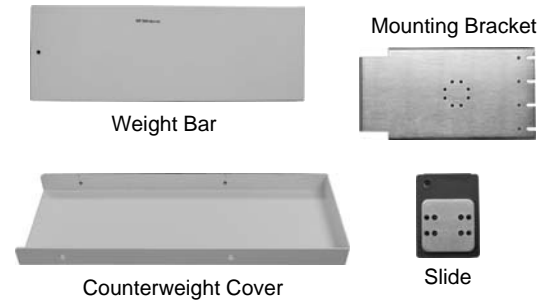

Tools Required for This Task: Phillips screwdriver.

1. Identify the 4-hole Slide-mounting pattern on the Mounting Bracket (below left). Align the mounting holes on the Slide with the mounting pattern on the Bracket. Secure Slide to Bracket with four (4) #10-32 x 5/8" PHMS (below right).
Installation Note: Screws are inserted from the inner side of the Bracket (not shown).

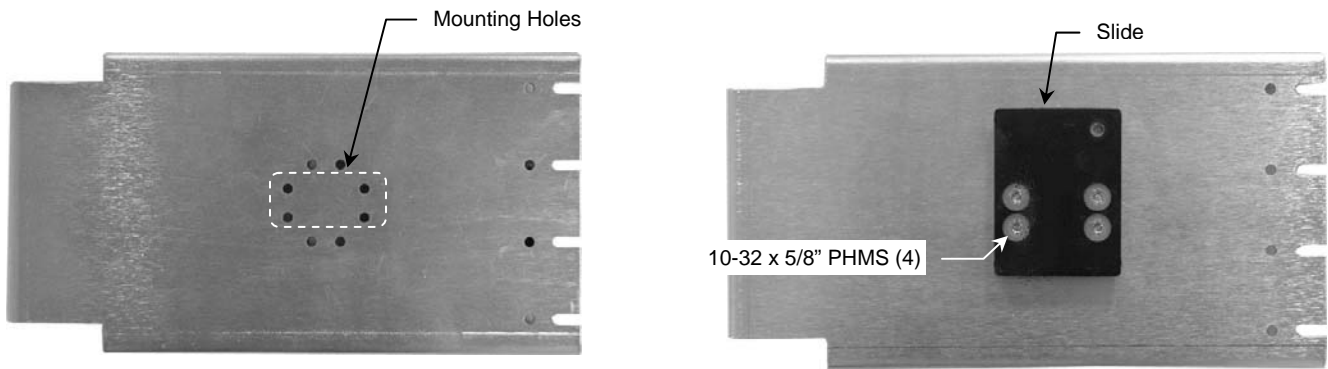

2. Turn Counterweight Cover upside down and slide the Weight Bar into Cover as shown below. Place the Mounting Bracket over the Weight Bar (Bracket fits inside Cover) and fasten Cover to Bracket with four (4) #10-32 x 1/4" FHMS.

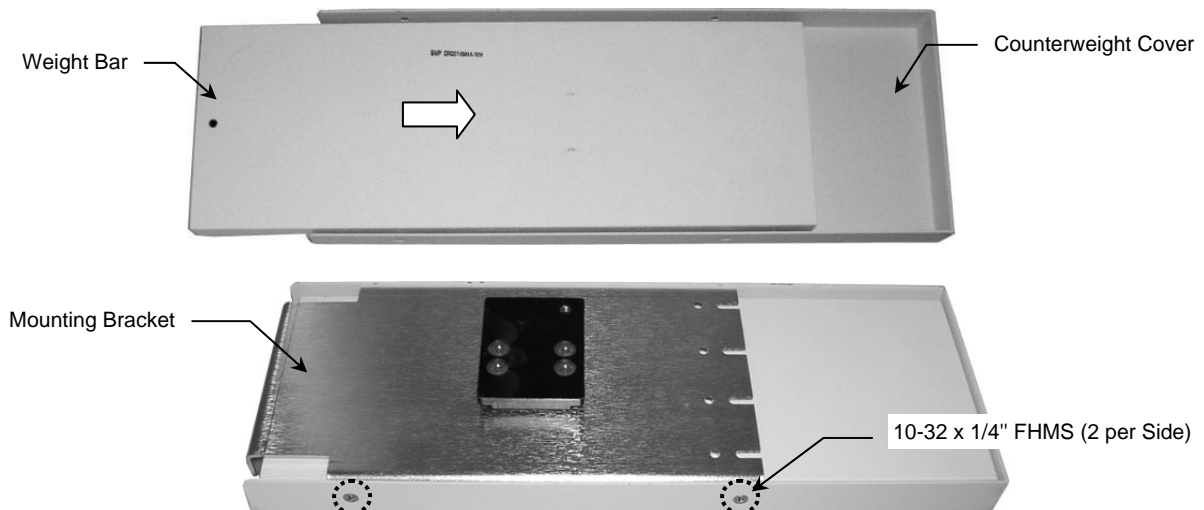

3. Ensure Slide is at the upper end of the Counterweight assembly. Insert Slide in top of Channel and carefully lower the Counterweight until it rests against the fixed stop at the bottom of the Channel (below right).

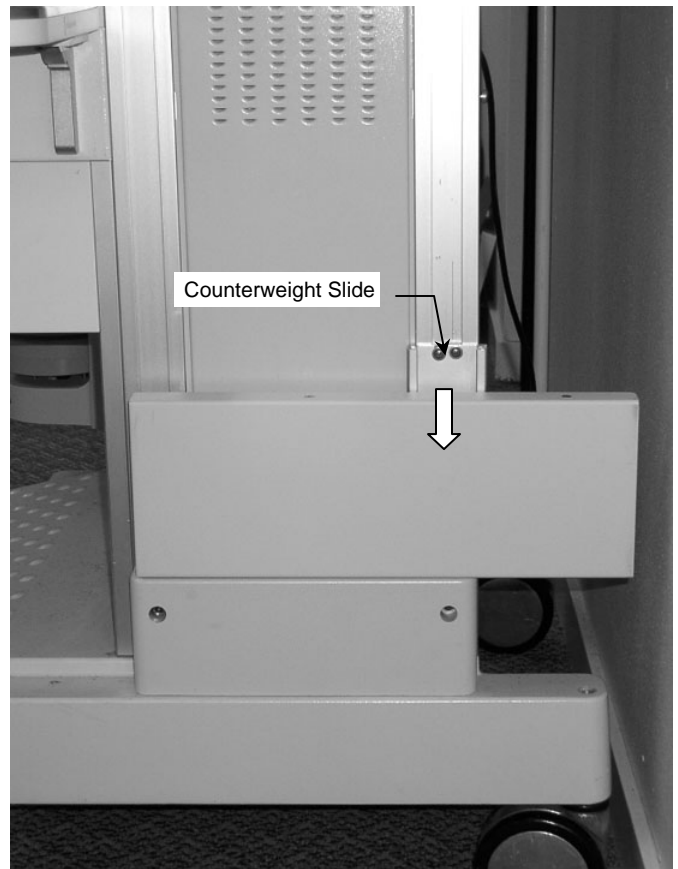
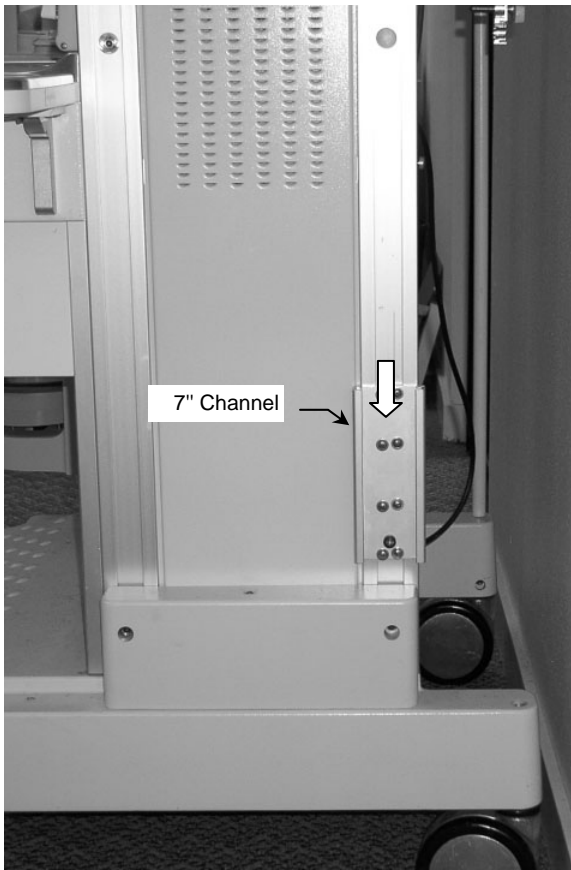

Attaching the Display Arm Mounting Bracket

Parts Reference

The following parts and hardware are included with this installation kit (see photo for parts, hardware not shown):

Item #	Description	Qty
1	Mounting Bracket Assembly	1
2	M6 x 12mm Flat Head Machine Screw (FHMS)	1
3	M6 x 8mm FHMS	2
4	M4 x 16mm Pan Head Machine Screw (PHMS) – 7900 Only	4
5	Sub plate, Model 7100	1
6	M4 x 14mm FHMS	4
7	M4 x 12mm PHMS	4
8	M4 x 8mm PHMS	4

Mounting Bracket Assembly



Subplate



Table Top Mount
(Supplied by Philips)



Tools Required for This Task: Phillips screwdriver.

Installation Notes

A. The tilt mechanism that holds the ventilator display may require tightening to hold the additional weight of the patient monitor. It is not recommended that this assembly be used for monitors weighing more than 30 pounds because tilt adjustment will be difficult with heavier weights. GCX makes no claims regarding the tip stability of the anesthesia machine because machine configuration and usage can vary considerably. We recommend that the hospital verify the stability of the final configuration.

B. The procedure for attaching the Mounting Plate/Bracket Assembly to a model 7100 ventilator display differs from the procedure for the model 7900. Identify your ventilator display below and follow the appropriate procedure in this installation guide.

Model 7100



Parts Required



Model 7900



Parts Required



Attaching the Table Top Mount to the MX800/MP60/70 Mounting Adapter

Installation Note: Table Top Mount is supplied by Philips with MX800/MP60/70 Monitor.

1. Fasten Table Top Mount to MP60/70 Adapter on Mounting Bracket with one (1) M6 x 12mm FHMS and two (2) M6 x 8mm FHMS (see below).

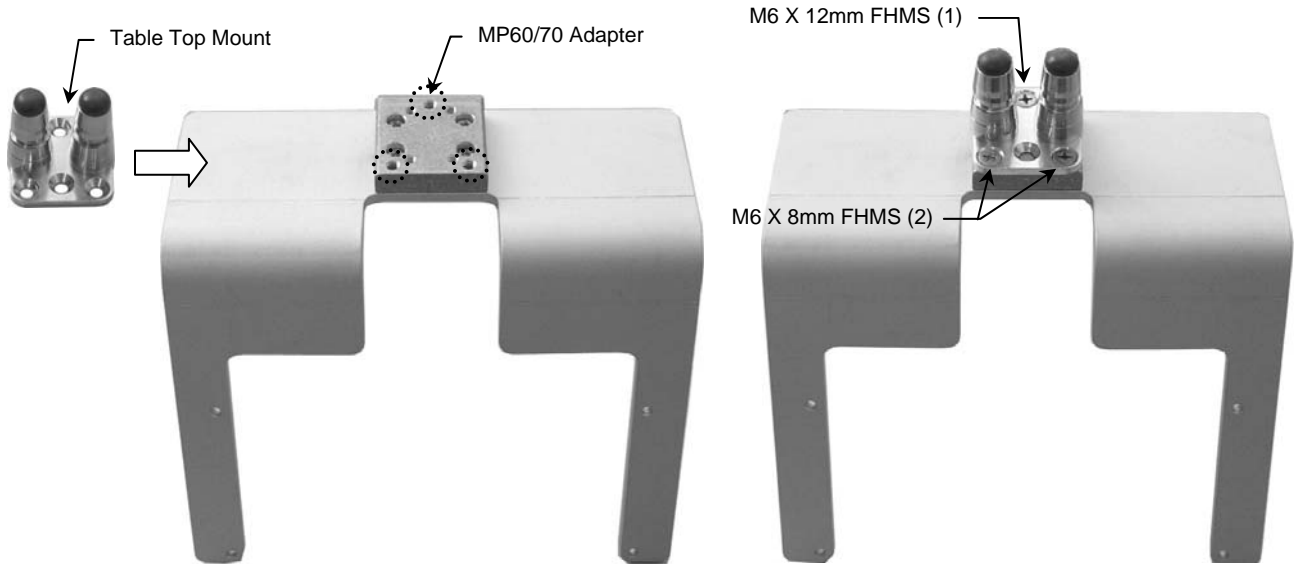

Attaching Mounting Bracket to Model 7100 Ventilator Display

1. Remove model 7100 display from display arm by unscrewing four (4) mounting screws from the rear of the display.
2. Using four (4) M4 x 14mm FHMS, attach the Sub Plate to four (4) threaded holes on the rear of the display.

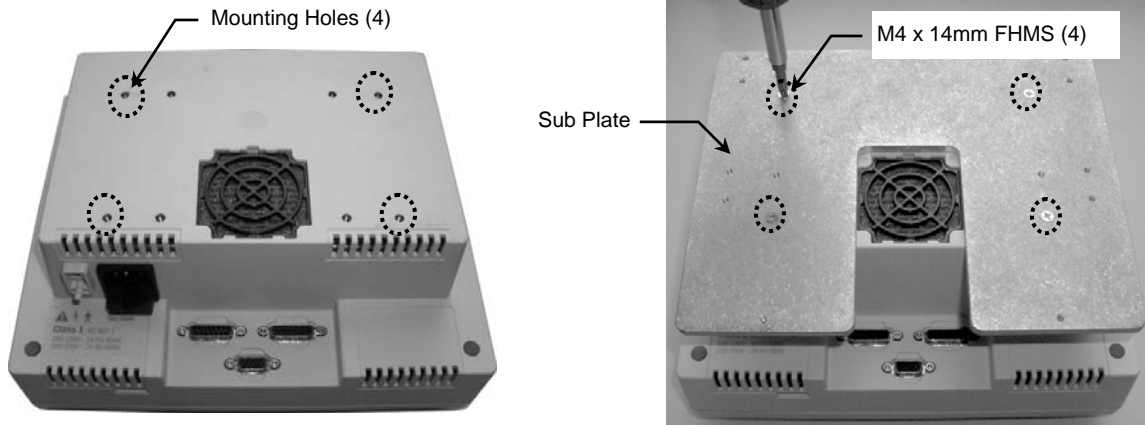

3. Locate four (4) threaded mounting holes on the Sub Plate (below left). Fasten the Sub Plate to the display arm with four (4) M4 x 8mm PHMS.

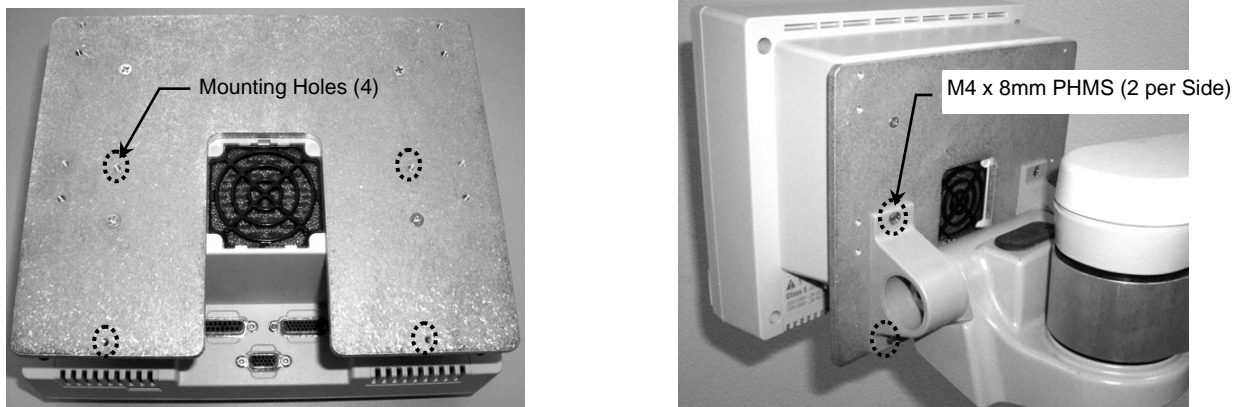

4. Locate four (4) mounting holes on the Sub Plate (below left). Fasten Mounting Bracket to Sub Plate with four (4) M4 x 12mm PHMS. **Installation Note:** An additional set of mounting holes is provided if additional height is required for the monitor (indicated by triangle in photo below left).

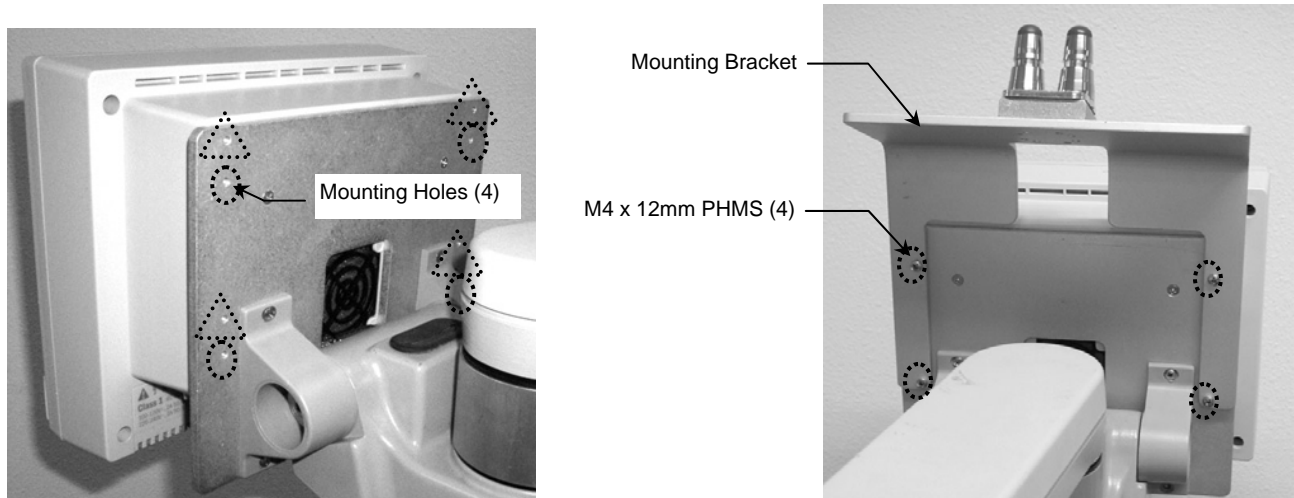

Attaching Mounting Bracket to Model 7900 Ventilator Display

1. Using four (4) M4 x 16mm PHMS, attach the Mounting Plate/Bracket to the two (2) outer mounting holes on each side of the rear housing.



Mounting MX800/MP60/70 on Table Top Mount

Mount monitor in accordance with Philips Table Mount instructions.



Attaching the Boom Arm Down Post or Side Post Assembly

Parts Reference

The following parts and hardware will be used in this installation (see photo for parts, hardware not shown):

Item #	Description	Qty
1	Down/Up Post Arm Assembly	1
2	#10-32 x 5/8" Pan Head Machine Screw (PHMS)	4
3	Slide Plate	1
4	Drop Plate	1
5	#10-32 x 3/4" PHMS	4
6	11.65" Post	1
7	5/32" Hex Key	1

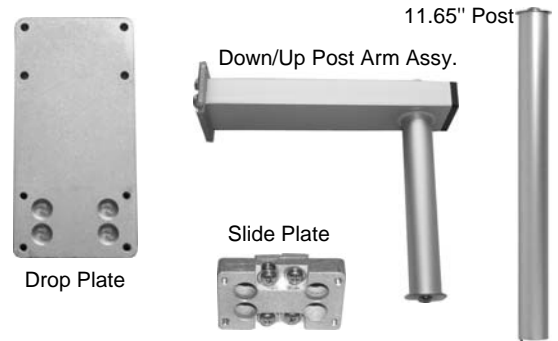

Tools Required for This Task: Phillips screwdriver, 5/32" hex key (provided for post replacement only).

Installation Note: An 11.65" Post is included in this kit for mounting dual module racks. Use the 5/32" hex key (provided) to replace the 6.9" Post with the 11.65" Post.

Attaching Slide Plate to Boom Arm

1. Insert the Dovetail Runners (rear of Slide Plate) into the dovetail fitting on the Boom Arm (below left). Tighten the four (4) PHMS to secure the Slide Plate (below right).

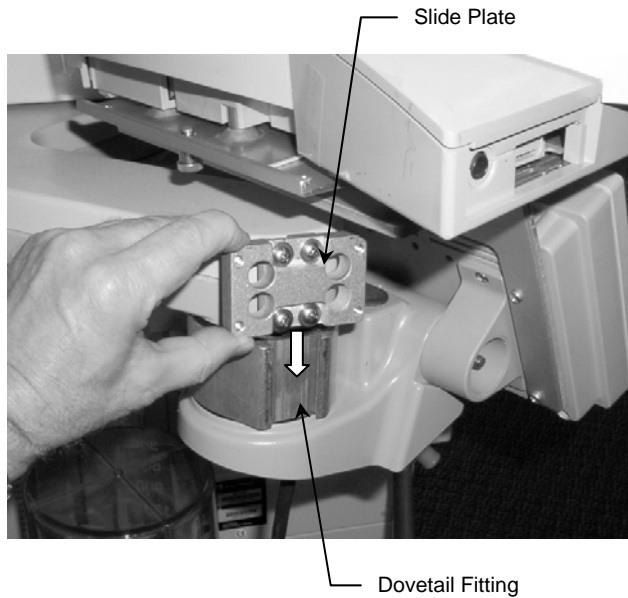

Attaching Arm as Up Post

1. Align Arm with Slide Plate (Post Up) and attach Arm to Plate with four (4) #10-32 x 5/8" PHMS (below left).
2. Clamp module rack (or other device with clamp) to the Post as shown (below right).

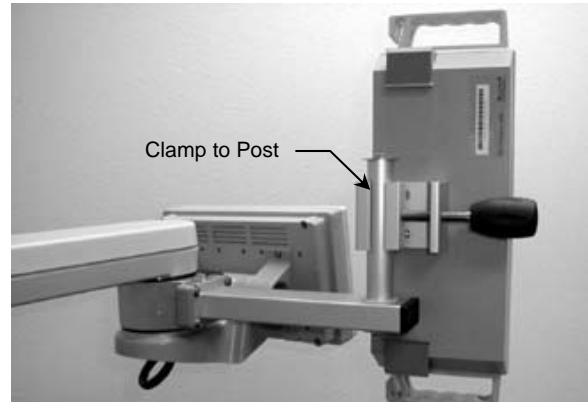
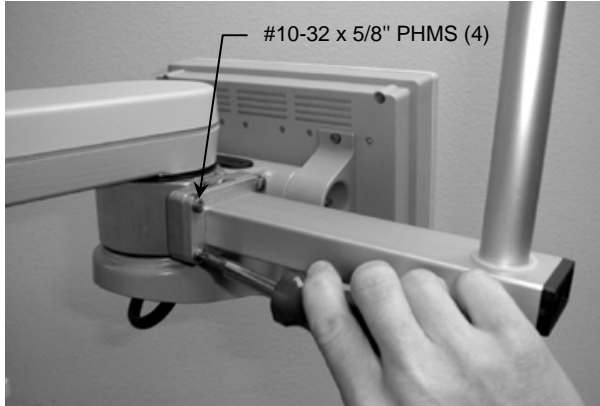

Attaching Arm as Down Post

1. Align Arm with Drop Plate by fitting screw heads (Arm) into counterbores on Drop Plate. Secure Arm to Drop Plate with four (4) #10-32 x 5/8" PHMS (below left).



2. Attach Drop Plate to Slide Plate using four (4) #10-32 x 3/4" PHMS (below center and right). Clamp module rack (or other device with clamp) to the Post.

