

Installation Guide

Philips MX800/MP20/30/40/50/60/70 IntelliVue M-Series Arm Mounting Kit for Dräger Primus Anesthesia Machine

The purpose of this guide is to:

1. Describe attachment of Table Top Mount to Mounting Adapter.
2. Describe attachment of Down Post to M-Series Arm.
3. Describe mounting of M-Series Arm.
4. Describe special mounting procedure for MP20/30 monitor.
5. Describe mounting of Flexible Module Server (FMS) on Down Post.
6. Describe Operation and Adjustment of M-Series Arm.

Parts Reference

The parts list below includes parts and hardware that will be used in this installation procedure (see photos for parts; hardware not shown).

Item #	Description	Qty
1	M-Series Arm Assembly with Mounting Adapter	1
2	6" Down Post	1
3	#10-32 x 3/8" Socket Head Cap Screw (SHCS)	3
4	M6 x 8mm Flat Head Machine Screw (FHMS)	2
5	M6 x 12mm FHMS	1
6	Nut Plate	2
7	M6 x 22mm Flat Head Socket Cap Screw (FHSCS)	2
8	5/32" Hex Wrench	1
*9	Spacer, MP20/30	1
*10	M6 x 16mm Pan Head Machine Screw (PHMS)	2

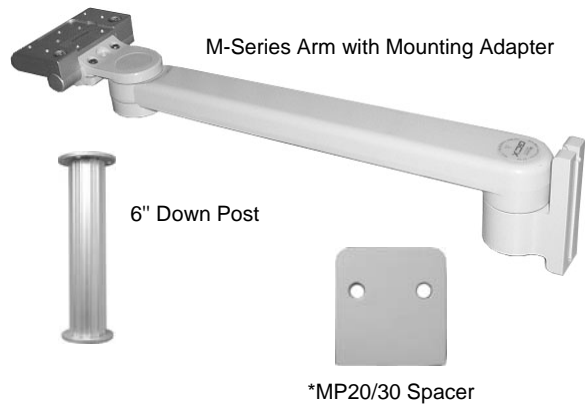

*See "MP20/30 non-Table Top Mount" on page 4 for use of these parts.

Tools Required: Phillips screwdriver, 5/32" hex wrench (provided).



CAUTION - Before mounting the Arm:

1. Ensure that the weight of the device being mounted does not exceed the load rating of your M-Series Arm. Check the "Max Load" rating label located on top of the arm at the Slide pivot point. It is not recommended that this arm be used for weights outside of this range.
2. If assistance is needed regarding an application, please contact a GCX product specialist at (800) 228-2555.

Attaching the Philips Table Top Mount to the Mounting Adapter

Installation Note: Do not attach the Table Top Mount to the Arm/Mounting Adapter if you will be mounting an MP20/30 monitor equipped with the mounting interface shown in photo (right). See "Mounting the Monitor on the Arm" (page 4) for instructions specific to this type of mounting plate.

Do Not Attach Table Top Mount if MP20/30 Monitor is Equipped with This Mounting Interface

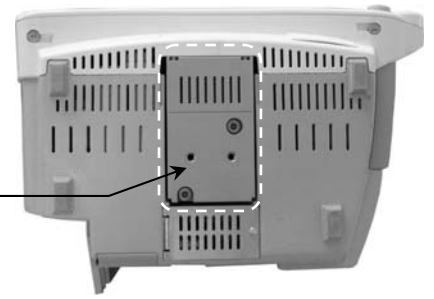

1. Fasten the Philips-supplied Table Top Mount to the Mounting Adapter on the M-Series Arm with one (1) M6 x 12mm FHMS and two (2) M6 x 8mm FHMS (see below).

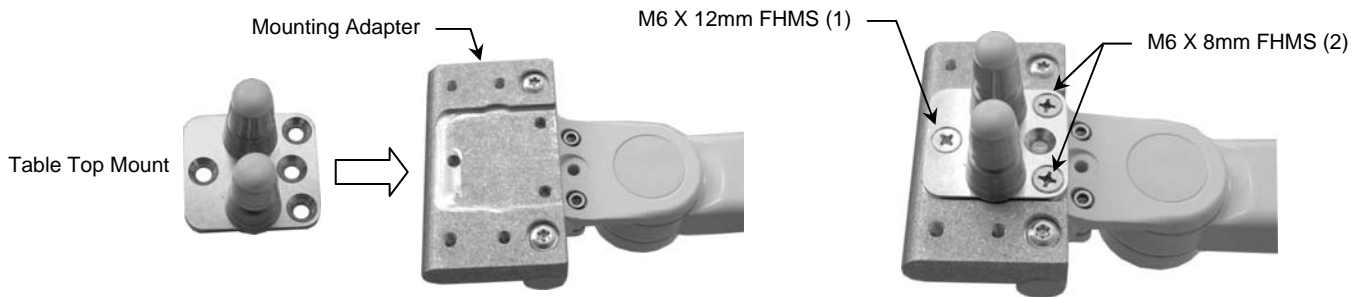

*Attaching the Down Post to the Arm

*The Down Post is used for mounting the Flexible Module Server (FMS). Skip this procedure if your IntelliVue monitoring system does not require a Down Post or FMS.

1. Align the three (3) mounting holes in the Lower Post Disc with the three (3) threaded holes in the Swivel Cup.
2. Using the 5/32" hex wrench, attach the Post to the Swivel Cup with three (3) #10-32 x 3/8" SHCS.

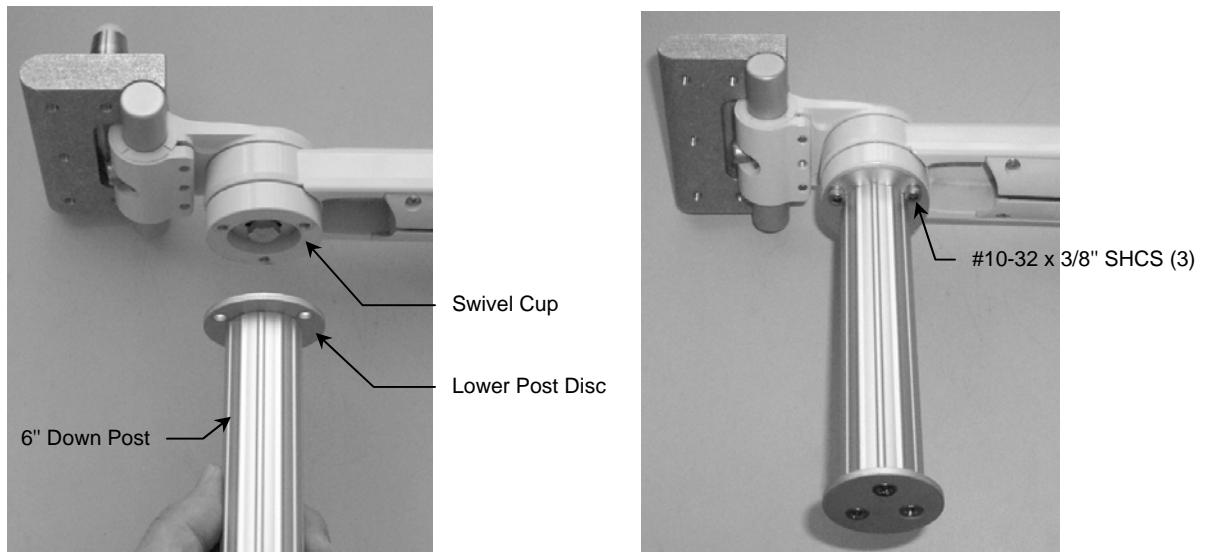

Mounting the Arm in the Accessory Track

1. Thread one (1) M6 x 22mm flat head socket cap screw (FHSCS) a few turns into each Nut Plate, leaving 15 mm of thread exposed per screw (right).
2. Insert Nut Plate/screw assemblies in top and bottom slots, holding the bottom screw in place to prevent it from falling out of the slot (right).
3. While holding bottom Nut Plate in position (below left), guide both Nut Plates into the track and move entire assembly up the track to the desired mounting position.
4. Using the 5/32" hex wrench provided, tighten bottom screw first, then top screw (below right).

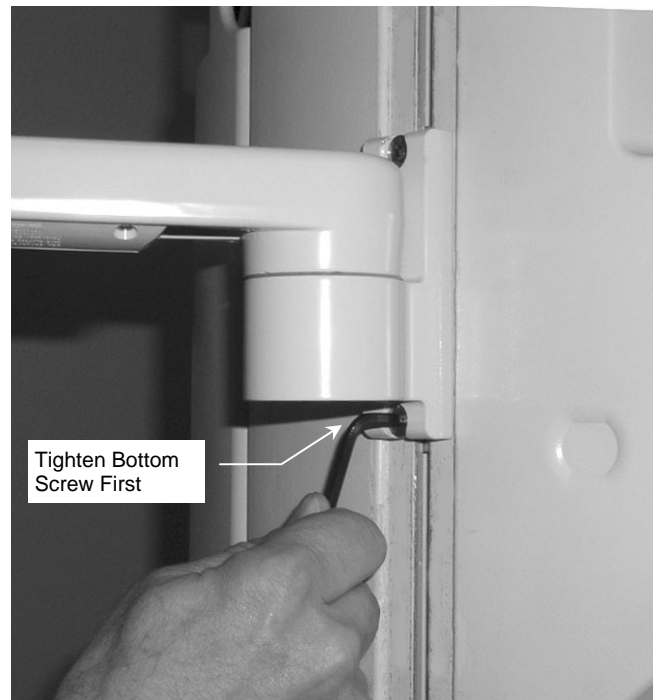
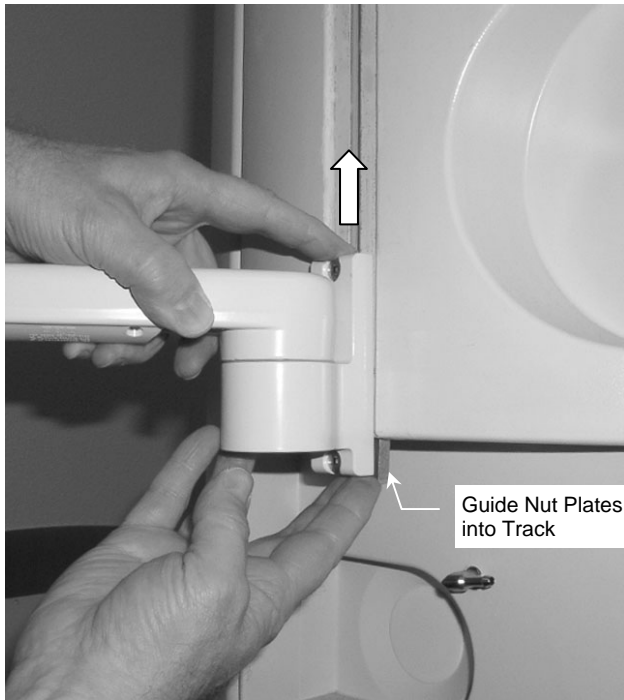
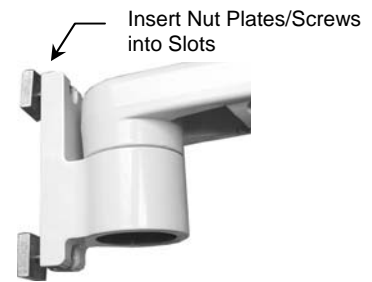
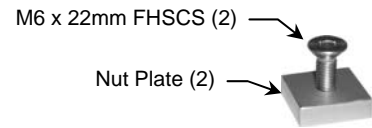

5. To adjust height of Arm in track, loosen the two (2) FHSCS, move the arm, and re-tighten screws.

Mounting the Monitor on the Arm

Table Top Mount

Mount the monitor in accordance with the Philips Table Top Mount instruction sheet.

MP20/30 non-Table Top Mount

1. Fit Spacer into recessed area on top of Mounting Adapter (below). Ensure Spacer remains between Mounting Adapter and monitor.
2. Insert two (2) M6 x 16mm PHMS through bottom of Mounting Adapter and thread into mounting holes in bottom of monitor (right).

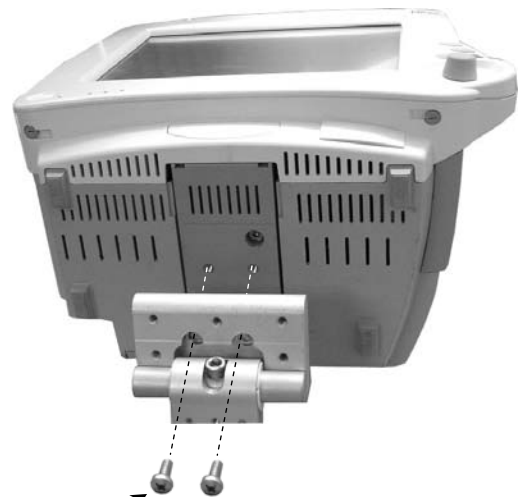
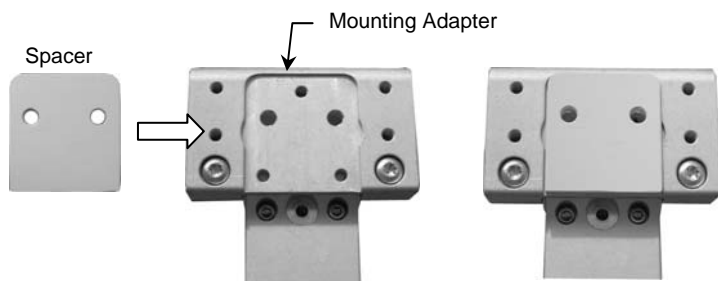

M6 x 16 mm PHMS (2)

*Mounting the Flexible Module Server (FMS) on the Down Post

** This procedure is not required if Down Post has not been installed.*

1. Attach the FMS to the Down Post by placing the Clamp around the Down Post and tightening the knob.

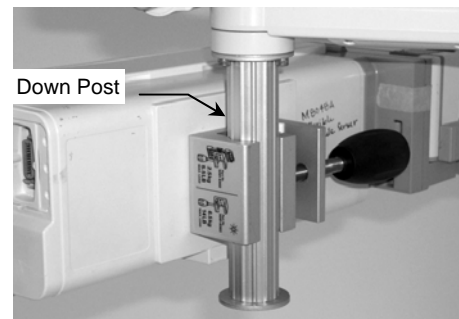
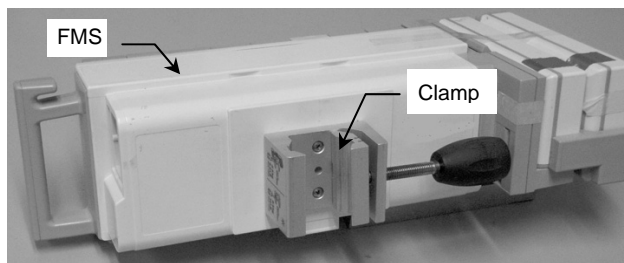

M-Series Arm Operation and Adjustment

Positioning Arm in Track

WARNING: Do not attempt to remove the Arm from the track while an instrument is mounted.

1. While *supporting the weight of the mounted instrument, loosen the two (2) flat head socket cap screws (FHSCS) in the Slide. A 5/32" hex wrench is provided for this task.
2. Push up or pull down at the end of the arm nearest the Slide. Tighten the screws to secure the Arm in the Channel

* It may be necessary to dismount the instrument before adjusting the Arm in the track.

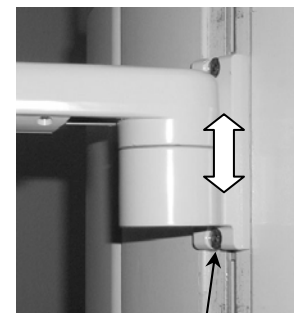

FHSCS (2)

Swivel and Swivel Tension

1. To swivel the mounted instrument simply push or pull the corners of the instrument.
2. To adjust swivel tension, tighten or loosen the Swivel Tension Nut with a 1/2" [13 mm] socket wrench or nut driver.

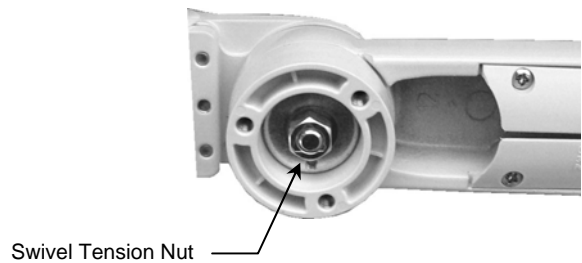

Tilt and Tilt Tension

1. To tilt the instrument, grasp the top and bottom of the instrument and tilt it to the desired angle.
2. To adjust tilt tension, equally tighten or loosen the two (2) Tilt Tension Adjustment screws using the supplied 5/32" hex wrench.

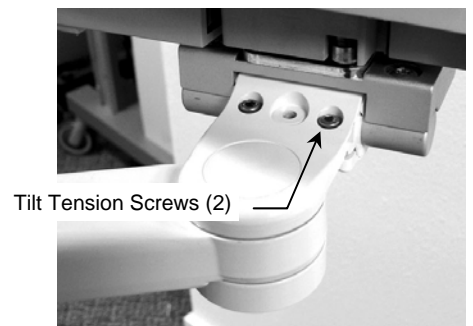

Pivoting the Arm

1. To pivot the Arm at the Slide, simply push on the side of the Arm or mounted instrument.
2. To adjust pivot tension, loosen or tighten the Pivot Tension Bolt using a 1/2" [13 mm] socket driver.

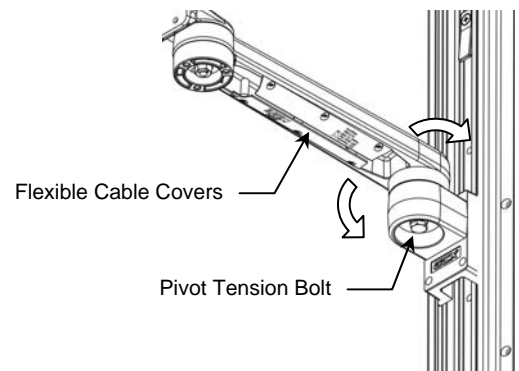

Cable Management

An open cavity beneath the arm (with flexible cable covers) allows management of cables between the front and rear of the arm.

Routine Maintenance

Periodically inspect all hardware associated with the mounting system. Tighten as required for optimal operation and safety.

Cleaning the Mounting Assembly

1. The mounting assembly may be cleaned with most mild, non-abrasive solutions commonly used in the hospital environment (e.g. diluted bleach, ammonia, or alcohol solutions).
2. The surface finish will be permanently damaged by strong chemicals and solvents such as acetone or trichloroethylene.
3. Do not use Steel wool or other abrasive material.
4. Damage caused by the use of unapproved substances or processes will not be warranted. We recommend testing of any cleaning solution on a small area of the arm that is not visible to verify compatibility.
5. Never submerge or allow liquids to enter the arm. Wipe any cleaning agents off of the arm immediately using a water-dampened cloth. Dry the arm thoroughly after cleaning.

CAUTION: GCX makes no claims regarding the efficacy of the listed chemicals or processes as a means for controlling infection. Consult your hospital's infection control officer or epidemiologist. To clean or sterilize mounted devices or accessory equipment, refer to the specific instructions delivered with those products.