

A man with a beard and short dark hair, wearing a red and white checkered button-down shirt, is looking towards the camera. He is holding a large set of blueprints. The background consists of vertical wood paneling. In the top left corner, there is a white box with the Philips logo and a dark blue box with the text 'Club Blue'. In the top right corner, there is a circular LED logo with a rainbow border. The main title 'Right first time' is in large white font, with 'Lighting solutions' and 'Contractor guide' in smaller white font below it.

PHILIPS

Club Blue



Right first time

Lighting solutions
Contractor guide

Quality meets versatility

for your key spaces and applications

Long-lasting, and low maintenance, LED lighting is here to support businesses of the world. Philips range of LED trade products is an affordable, versatile range of LED lighting for the market. Offering you the quality and reliability that you are looking for.

Our LED trade products range comprises of products to cover your key applications – downlights, floodlights, troffers and battens, all boasting high performance and cost efficiency. Designed to serve a comprehensive range of spaces – whether for residential or business, hotel or retail shops, indoor spaces or outdoor areas, the portfolio of our LED trade products will be able to meet your diverse needs.

Our range of LED trade products have long lifetimes, which means less maintenance and fewer replacements. The range also brings you significant energy savings compared with traditional lighting fixtures – making this a more sustainable lighting solution for you and your clients.

Switching to Philips LED trade products is a breeze. Every product in the range is designed to enable hassle-free, 'hole-for-hole' retrofit replacement of similar conventional lighting fixtures without time consuming re-working.

Club Blue is here



Club Blue is a contractor programme created by Philips Lighting Australia, for Australian electricians.

Club Blue will keep you up-to-date with the latest in LED and connected lighting technology and guide you to the right lighting solution, for whatever job you are working on.

- Free product offers and information
- Promotions
- Project case studies
- Opportunity for free face-to-face LED training
- Online training modules. • Monthly



JOIN TODAY. IT'S FREE

We don't want to exclude anyone. That's why Club Blue costs nothing to join.

Go to www.philips.com.au/ClubBlue to sign up today.

Get Educated

Although LED technology has been around for a while, it's only recently started to transform the lighting industry in Australia. With the opportunity for regular free face-to-face training events for Club Blue members, you will be able to keep up-to-date with the latest developments for you and your customers.

Common LED myths

There are many benefits to using LED lighting, but there are also numerous misconceptions about it. We help to separate the facts from fiction by busting some of the common myths.



Myth 1

LEDs last forever

LEDs have a long source life but they do still slowly fade over time. Ambient temperatures, electrical drive currents, and the effectiveness of cooling systems are all factors that contribute to this phenomenon called lumen depreciation. While LEDs typically do not catastrophically fail, lumen depreciation is a critical factor in determining useful lifetimes.



Philips designs our white light LED products to sustain 70% of initial lumen output (L70)

Myth 2

White LEDs produce over 180 lumens per watt

These results are often obtained in labs where LED chips are tested at room temperature conditions with short "pulse" tests that produce a high lumen output. While the results are not necessarily "wrong," they do not reflect the typical expected output of LEDs in practical use. When used in lighting fixtures, LED output often decrease by 30–40%.



Philips does not use raw LED specifications or "instant on" output testing. Instead, we use independent testing labs to validate the output of our fixtures at constant, realistic thermally-stable operating temperatures in rated, ambient environments.

Myth 3

3 Watt LEDs are brighter than 1 Watt LEDs

The wattage of a LED is not directly comparable to the wattage of a traditional light source or even from one LED to another. Two different LEDs can consume the same power but differ noticeably in light output. Thus, when selecting LEDs or LED fixtures, it is more about a quality and consistent light output rather than absolute power.



Philips develops solutions based on the light output, distribution and quality needed for the application and not based on the particular wattage of LEDs.

Myth 4

LED light quality is poor

The Colour Rendering Index (CRI) is the prevalent method used to judge light quality, though there are known deficiencies and limitations associated with it, especially for LED-based light sources. Research in at least one study found participants preferring LED sources over halogen and incandescent because of overall colour appearance, not a CRI value. The International Commission on Illumination (CIE) has proposed a new metric called Colour Quality Scale (CQS), which will incorporate colour rendering, chromatic discrimination and observer preferences into the measure of Colour Quality.



Philips works to design high quality and consistent light output. We measure our colour consistency in SDCM (Standard Deviation of Colour Matching).

Myth 5

LEDs generate no heat

When used in lighting applications, LEDs do not radiate infrared heat, only visible light. However, waste heat is produced during the conversion of electricity into light. If not properly removed from the lighting system, this may potentially damage the LEDs. Heat removal can be accomplished through heat sinks that draws heat away from the LED and dissipate it into the surrounding air.



Philips designs, simulates and tests our products for high thermal efficiency to ensure optimal performance and maximise the lifetime of our LEDs.

Myth 6

LEDs are not resistant to vibration

There are no moving parts, filaments or fragile glass enclosures with LED lighting. LEDs are therefore very suitable for use in a wide range of applications.



Philips designs products that must pass vibration tests according to IEC standards. In some cases, we use military standards for higher grade of assurance.

Myth 7

LED systems cost too much

The initial investment of LED systems is higher than that of conventional systems, but due to the long life of the LED and energy savings ranging between 50%-70% compared to conventional light sources, the economic payback can typically be seen in less than two years. Additionally, the upfront cost of LED systems is also dropping rapidly.

 **Philips provides cost-effective solutions that have a proven and compelling return on investment (ROI).**

Myth 8

LEDs are not bright enough

LED traffic lights are already common and are certainly a sign that LEDs are bright enough to be seen even in daylight. Outdoor roads, tunnels and entire building façades are being lit entirely with LEDs today. By any measure, LEDs have enough light output for use even in very large outdoor daylight-visible installations.



Philips products have been used in more than 20,000 installations worldwide, including large exterior projects such as the Stamford Bridge Stadium (Chelsea Football Club), Al Saad Stadium (Doha, Qatar) and Federal Highway (Malaysia).

Myth 9

LED lights are dangerous to our eyes

There is a small amount of blue light generated by LED but it is a tiny fraction of the emissions from natural daylight, and similar to emissions from other artificial light sources like incandescent, halogen and energy savers or fluorescent lamps. Typical daily exposure to natural blue light is at least 1,000 times stronger compared to artificial light indoors.



Philips LED products comply with all the relevant regulations and legislation, ensuring products are safe to use. This means that being exposed to a LED light is as safe as being exposed to any other artificial light source, and safer than being exposed to natural lighting conditions – such as walking in the open air.



Take the next step

See how Philips LED trade products range can flexibly address your business needs.

Contact your local Philips sales Representative for more information or call 1300 304 404

Why Philips downlights?

A downlight provides general and even lighting with a wide beam angle. It can play a primary or secondary role in your lighting design, and is suitable for places such as living room, bedroom, study room, corridor and kitchen.



Wide beam angle

More coverage, better illumination

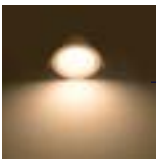

Beam angle 100°

Anti-glare diffuser

Gives a soft, even glow



Even and comfortable light

Brighter illumination

Philips LED provides greater energy efficiency when compared to similar LED lights with the same wattage and colour temperature, ensuring you brighter illumination for the same consumption.

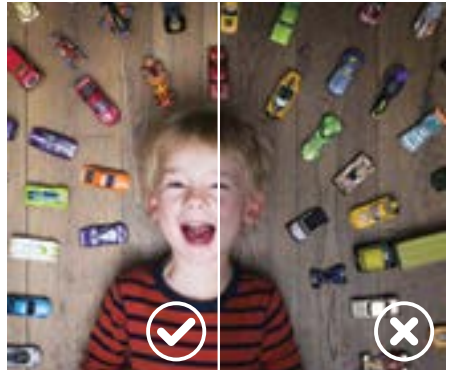

Lumen determines the overall brightness of the bulb. **Therefore, the bigger the lumen value the brighter the light.**



Up to 25,000 hours long life

Reliable quality

Though LEDs generally have a long lifespan, they are sensitive to heat, and may reduce in lifespan if overheated. Philips lights are designed to counter the heat generated from the driver, as well as the heat emitted from the light source.

Philips heat management design

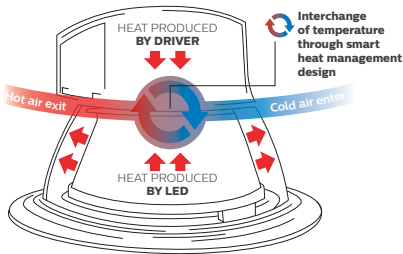

Some LEDs may boast of a long lifespan but as time passes it may lose its brightness and effectiveness. **Philips ensures that our lights last at least up to 25,000 hours (at L70) to maintain brightness.**



Quality light for natural colours

Natural colours

Better quality lights are able to reproduce colours naturally. The Colour Rendering Index (CRI) is a gauge that ranges from 1 - 100, and a higher value provides better colour quality.

CRI chart

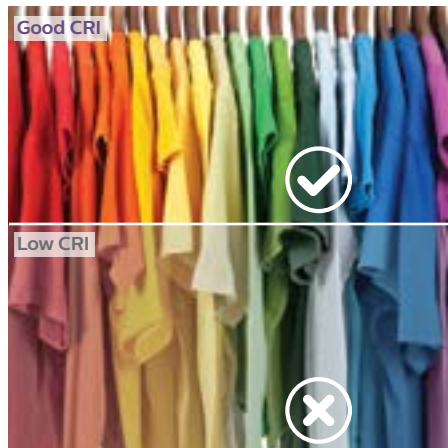

Philips LED downlights have a CRI value above 70.

What is IC rating?

The classification of various types of recessed luminaires suitable for different installation processes was published in the AS/NZS 60598.2.2:2016 Part 2:2 standards, commonly known as the "IC rating".

Whilst the classification is a minimum safety standard, the responsibility of the safety of the complete installation rests with the contractor to ensure all materials used are thermally compatible, and to adhere to luminaire manufacturer's instructions.

It is also important to note that the IC classification does not take into consideration the implication on product performance. Possible issues such as flickering, reduced lifetime, product shut down and restart at intervals, which could be caused by overheating.

Philips products are designed to adhere to local safety standards whilst not compromising on performance. With Philips, you can be sure that you are buying a quality, reliable and safe product!

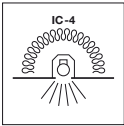

IC-4

- Suitable for residential or commercial use
- Fitting can be covered with building insulation
- Can be used where air transfer is not permitted or not desired between living space & roof space

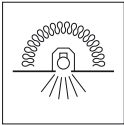

IC

- Suitable for residential or commercial use
- Fitting can be loosely covered with building insulation
- Can be used where some air transfer is permitted or desired between living space & roof space

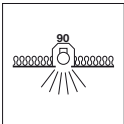

CA 90

- Suitable for residential or commercial use
- Fitting cannot be covered with building insulation
- Insulation can be placed against the sides of the fitting

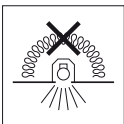

Do not cover

- Suitable for residential or commercial use in AU. Not for residential use in NZ.
- Fitting cannot be covered with building insulation
- Insulation must be placed as per clearance distances according to manufacturer's installation guide

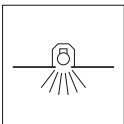

Non-IC

- Suitable for commercial use only
- Not suitable for use in residential dwellings or other places where insulation may be installed now or in the future
- Not tested for use with building insulation

What is Ingress Protection (IP) rating?

IP ratings describe the environmental protection that a product has from particles and liquids.

First digit = Protection against solid objects (0 - 6)



Digit

0

Non protected



1

Protected against a solid object greater than 50mm, such as a hand



2

Protected against a solid object greater than 12.5mm, such as a finger



3

Protected against a solid object greater than 2.5mm, such as a wire



4

Protected against a solid object greater than 1.0mm, such as a thin strap



5

Dust protected. Protects ingress of dust sufficient to cause harm.



6

Dust tight. No ingress of dust.

Usage and common application

IP20 – suitable for most indoor application

IP44 – suitable for under canopy and bathroom

IP54 – suitable for under canopy in outdoor areas, industrial application etc

IP65 – suitable for industrial application and outdoor areas

IP68 – suitable for underwater and in-ground application

The above information serves as a reference only, always check with product manufacturer for suitability.

Second digit = Protection against liquids (0 - 8)



Digit

0

Non protected



1

Protected against dripping water



2

Protected against dripping water when tilted up to 15 degrees



3

Protected against spraying water at an angle of up to 60 degrees

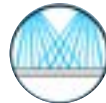

4

Protected against splashing water from any direction



5

Protected against jets of water from any direction



6

Protected against the effects of temporary immersion. Up to 30mins, between 15cm to 1m



7

Protected against the effects of temporary immersion in water



8

Protected against the effects of continuous immersion in water

Downlights



Essential SmartBright G3
Downlight - Dimmable

Pg. 16 DN029B-1



Essential SmartBright
G3 Downlight - Colour
Selector and Dimmable

Pg. 18 DN029B-2



Essential SmartBright G3
Downlight - Step Dimming

Pg. 20 DN029B-3



GreenSpace Gen 4
Downlight

Pg. 22 DN29XB



GreenSpace Power
Downlight

Pg. 26 DN28XB-8



GreenSpace Surface
Mounted Downlight

Pg. 28 SM29XC

Ceiling oyster



Essential Slimline Oyster

Pg. 30 3181X

R Residential applications

C Commercial/industrial applications

Panel



SmartBright
Slim Panel

Pg. 32 RC091V



Coreline 2.5

Pg. 34 RC100C & SM100C



Smart Panel 3

Pg. 36 RC160V

Batten



SmartBright Batten

Pg. 38 BN008C



SmartBright Batten -
Slim Standalone

Pg. 40 BN012C



SmartBright Batten G2 -
Slim Trunkable

Pg. 42 BN013C



CoreRange Batten -
Standalone

Pg. 44 BN188C



CoreRange Batten -
Trunkable

Pg. 46 BN189C

Waterproof batten



SmartBright Wide
Waterproof Batten

Pg. 48

WT008C



SmartBright
Waterproof Batten G2

Pg. 50

WT066C



Coreline
Waterproof Batten

Pg. 52

WT120C

Vandal-proof batten



Vandalite LED

Pg. 54

BCW098

Highbay



GreenUp Highbay

Pg. 56

BY550P



GreenPerform
Highbay G3

Pg. 58

BY698P

R Residential applications

C Commercial/industrial applications

Lowbay



Pg. 60 BY288P

Floodlight



Pg. 62 BVP161



Pg. 64 BVP38X

Street/road light



Pg. 66 BRP210



Pg. 68 BGS007

Security



Pg. 70

BWS220

Bollard



Pg. 72

BCP15X

Bulkhead

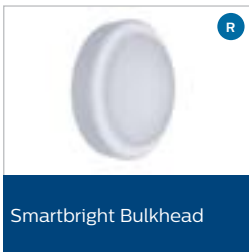

Pg. 74

WL008C

 Residential applications

 Commercial/industrial applications

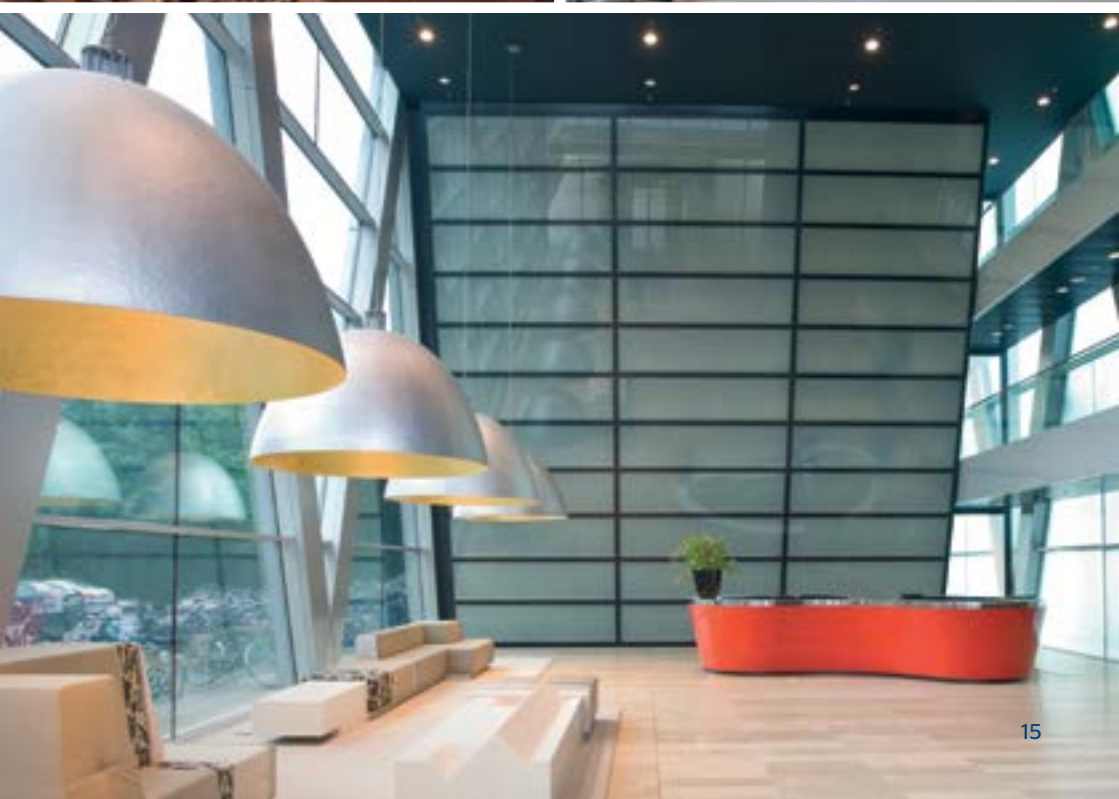

Essential SmartBright G3

dimmable



Benefits

- Reliable LED downlight
- Trailing/ leading edge dimmable
- Easy to install and IC-4 rated
- 3 years warranty

Model	Essential SmartBright Downlight G3 (DN029B-1)
Type	LED8
Equivalent of	50W halogen
Power	10W
System lumen	800lm
Power factor	0.8
Type	Trailing/ leading edge dimmable**
Electrical Class	Class II
Input Voltage	220V-240V, 50/60Hz
CCT	3000K (WW) and 4000K (NW)
CRI	>80
Beam Angle	105°
Operating Temperature	25°C (-20°C < ta < 40°C)
Lifetime (L70B50)*	25,000 hours
IP rating	IP44 (front)
Insulation rating	IC-4
Mounting Type	Recessed
Housing colour	RAL9003
Cable	1.2m pre-wired AU flex & plug
Material	Diffuser: Polycarbonate (PC) Housing: Polybutylece Terephthalate (PBT)
Application	Residential, general lighting areas, corridors, retail

* When a new fitting reaches 70% of full potential

** Compatible with selected dimmers, please refer to dimming list below

Recommended dimmers

Brand	Model	Max. fitting per dimmer	Dimming range
Clipsal	32E450UDM	8	10%-100%
Clipsal	32ELEDM	8	10%-100%
Legrand	Cat 400T	8	10%-100%
SAL	SDA450	8	10%-100%
Diginet	MEDM	8	10%-100%
Philips Dynalite	DDLE801	10 per channel	5%-100%
Philips Dynalite	DDLE801 with DGTM402	25 per channel	5%-100%

Philips recommends to select from this list of dimmers which are tested for compatibility with the downlight.

Dimensions

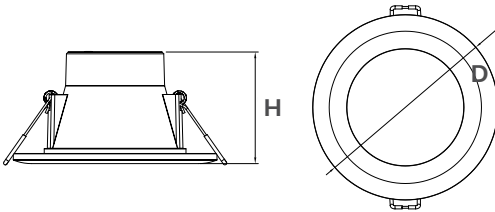

Model	Cut-out/ B (mm)	Diameter/ A (mm)	Height C (mm)	Weight (kg)
DN029B-1 LED8	Ø 85-95	Ø 115	64	0.22

Dimensions shown above are nominal measurement.
Slight variation in dimension may occur in production.

Order placement information

Order Code	Barcode	Description
ESB3LED8WWTLE	8710163314686	10W, 800lm, 3000K, Trailing/ leading edge dimmable, cut-out: 85-95mm
ESB3LED8NWTLE	8710163314693	10W, 800lm, 4000K, Trailing/ leading edge dimmable, cut-out: 85-95mm
ESB3D90BATRIM	911401712672	Brushed aluminium trim for DN029B 90mm cut-out

Essential SmartBright G3

Colour selector and dimmable



Benefits

- Select from 3 colour temperatures with a slide of the dial
- Trailing/ leading edge dimmable
- Brush aluminium trim included
- Easy to install and IC-4 rated
- 3 years warranty

Model	Essential SmartBright Downlight G3 (DN029B-2)
Type	LED8
Equivalent of	50W halogen
Power	10W
System lumen	800lm
Power factor	0.8
Type	Trailing/ leading edge dimmable**
Electrical Class	Class II
Input Voltage	220V-240V, 50/60Hz
CCT	Select from 3000K (WW), 4300K (CW), 6500K (DL) with the selector dial
CRI	>80
Beam Angle	105°
Operating Temperature	25°C (-20°C < ta < 40°C)
Lifetime (L70B50)*	25,000 hours
IP rating	IP44 (front)
Insulation rating	IC-4
Mounting Type	Recessed
Housing colour	RAL9003
Accessory	Brush aluminium trim, click on to fitting
Cable	1.2m pre-wired AU flex & plug
Material	Diffuser: Polycarbonate (PC) Housing: Polybutylece Terephthalate (PBT)
Application	Residential, general lighting areas, corridors, retail

* When a new fitting reaches 70% of full potential

** Compatible with selected dimmers, please refer to dimming list below

Recommended dimmers

Brand	Model	Max. fitting per dimmer	Dimming range
Clipsal	32E450UDM	8	10%-100%
Clipsal	32ELEDM	8	10%-100%
Legrand	Cat 400T	8	10%-100%
SAL	SDA450	8	10%-100%
Diginet	MEDM	8	10%-100%
Philips Dynalite	DDLE801	10 per channel	5%-100%
Philips Dynalite	DDLE801 with DGTM402	25 per channel	5%-100%

Philips recommends to select from this list of dimmers which are tested for compatibility with the downlight.

Dimensions

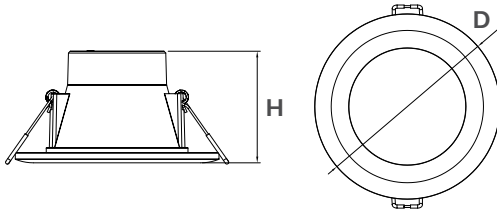

Model	Cut-out/ B (mm)	Diameter/ A (mm)	Height C (mm)	Weight (kg)
DN029B-2 LED8	Ø 85-95	Ø 115	64	0.22

Dimensions shown above are nominal measurement.
Slight variation in dimension may occur in production.

Order placement information

Order Code	Barcode	Description
ESB3LED8CCTTLE	8710163314709	10W, 800lm, 3000K/4300K/6500K, Trailing/ leading edge dimmable, brushed aluminium trim included, cut-out: 85 - 95mm

Essential SmartBright G3

Step dimming



Benefits

- Adjust light level from the switch
- Saves cost from installation
- Easy to install and IC-4 rated
- 3 years warranty

Model	Essential SmartBright Downlight G3 (DN029B-3)
Type	LED8
Equivalent of	50W halogen
Power	10W
System lumen	800lm
Power factor	0.8
Type	Step dimming (100%-40%-10%)
Electrical Class	Class II
Input Voltage	220V-240V, 50/60Hz
CCT	3000K (WW) and 4000K (NW)
CRI	>80
Beam Angle	105°
Operating Temperature	25°C (-20°C < ta < 40°C)
Lifetime (L70B50)*	25,000 hours
IP rating	IP44 (front)
Insulation rating	IC-4
Mounting Type	Recessed
Housing colour	RAL9003
Cable	1.2m pre-wired AU flex & plug
Material	Diffuser: Polycarbonate (PC) Housing: Polybutylece Terephthalate (PBT)
Application	Residential, general lighting areas, corridors, retail

* When a new fitting reaches 70% of full potential

Dimensions

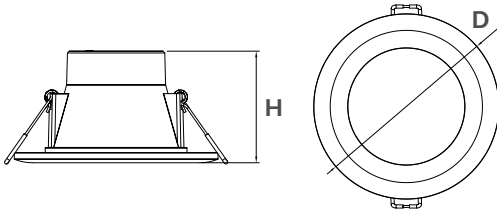

Model	Cut-out/ B (mm)	Diameter/ A (mm)	Height C (mm)	Weight (kg)
DN029B-3 LED8	Ø 85-95	Ø 115	64	0.22

Dimensions shown above are nominal measurement.
Slight variation in dimension may occur in production.

How does step dimming work?

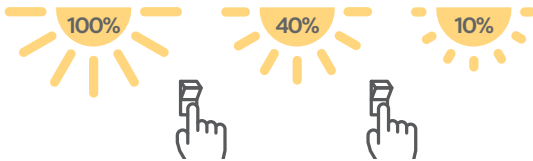

When the light is turned on, the default light level is set at 100%.
To dim down to the mid level (40%), flick the switch off and on.
To dim down to the lowest level (10%), flick the switch off and on again.

Switch from the default level to the desired level within 8 seconds.
The fitting will automatically adjust to the default level outside of the switching window.

Order placement information

Order Code	Barcode	Description
ESB3LED8WWSD	8710163314716	10W, 800lm, 3000K, step dimming, cut-out: 85-95mm
ESB3LED8NWSD	8710163314723	10W, 800lm, 4000K, step dimming, cut-out: 85-95mm
ESB3D90BATRIM	911401712672	Brushed aluminium trim for DN029B 90mm cut-out

GreenSpace

Gen 4 downlight



Benefits

- Energy-efficient. Up to 105lm/W
- Comprehensive range. From 650lm – 2300lm, three cut-out sizes and two colour temperatures
- Available in white and aluminium reflector

Family Name	GreenSpace Gen 4 LED Downlights			
Model	DN290B – Micro	DN291B – Mini	DN292B – Compact	DN293B – Compact Power
Lumen/Watt	DN290B Fixed – 7W @ 650lm, 93lm/W	DN291B Fixed – 11.5W @ 1100lm, 95lm/W DN291B DALI – 12.4W @ 1100lm, 88lm/W	DN292B Fixed – 16.4W @ 1600lm, 97lm/W DN292B DALI – 15.4W @ 1600lm, 103lm/W	DN293B Fixed – 22.3W @ 2300lm, 103lm/W DN293B DALI – 20.8W @ 2200lm, 105lm/W
CCT	3000K, 4000K			
CRI	83			
Flex and Plug	Yes			
Lifetime (L70B50)*	50,000 hours			
Unified Glare Ratio (UGR)	≥23-25			
Material	WH – PC diffuser with white reflector & trim ALU – PC diffuser with aluminium reflector, temper glass front cover & white trim			
Driver	PSU – Integrated fixed output driver PSD – External DALI-compatible driver			
Installation	Recessed mounting with flexible spring clips			
IP Rating	IP20, IP54** (WP)			
AS/NZS classification	CA90			
Colour of Housing	White			

* When a new fitting reaches 70% of full potential

Dimensions

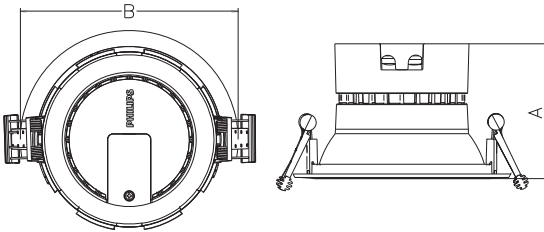

Model	Cut-out (mm)	Diameter/ B (mm)	Height/ A (mm)	Weight (kg)
White reflector range				
DN290B WH (WP)	105	122	95 (99)	0.28 (0.46)
DN291B WH (WP)	150	167	105 (109)	0.38 (0.5)
DN292B/DN293B WH (WP)	200	218	114 (118)	0.5 (0.63)
Aluminium reflector range				
DN290B ALU and WP	105	122	95	0.46
DN291B ALU and WP	150	167	105	0.6
DN292B/DN293B ALU and WP	200	218	118	0.85

Dimensions shown above are nominal measurement.
Slight variation in dimension may occur in production.

For Order placement information, see page 22.

Order placement information

Order Code	Barcode	Description
DN290B7W3KFA	8710163300399	7W, 650lm, 3000K, fixed output driver, aluminium reflector
DN290B7W4KFA	8710163300405	7W, 650lm, 4000K, fixed output driver, aluminium reflector
DN290B7W3KFW	8710163300412	7W, 650lm, 3000K, fixed output driver, white reflector
✓✓ DN290B7W4KFW	8710163300429	7W, 650lm, 4000K, fixed output driver, white reflector
DN290B7W3KFAW	8710163300672	7W, 650lm, 3000K, fixed output driver, IP54, aluminium reflector
DN290B7W3KFWW	8710163300610	7W, 650lm, 3000K, fixed output driver, IP54, white reflector
DN290B7W4KFWW	8710163300627	7W, 650lm, 4000K, fixed output driver, IP54, white reflector
DN291B11W3KFW	8710163300559	11.5W, 1100lm, 3000K, fixed output driver, white reflector
✓✓ DN291B11W4KFW	8710163300566	11.5W, 1100lm, 4000K, fixed output driver, white reflector
DN291B11W3KDA	8710163300436	12.4W, 1100lm, 3000K, DALI, aluminium reflector
DN291B11W4KDA	8710163300443	12.4W, 1100lm, 4000K, DALI, aluminium reflector
DN291B11W3KDW	8710163300450	12.4W, 1100lm, 3000K, DALI, white reflector
DN291B11W4KDW	8710163300467	12.4W, 1100lm, 4000K, DALI, white reflector
DN291B11W3KFWW	8710163300634	11.5W, 1100lm, 3000K, fixed output driver, IP54, white reflector
DN291B11W4KFWW	8710163300641	11.5W, 1100lm, 4000K, fixed output driver, IP54, white reflector
DN292B16W3KFW	8710163300573	16.4W, 1600lm, 3000K, fixed output driver, white reflector
✓✓ DN292B16W4KFW	8710163300580	16.4W, 1600lm, 4000K, fixed output driver, white reflector
DN292B15W3KDA	8710163300474	15.4W, 1600lm, 3000K, DALI, aluminium reflector
DN292B15W4KDA	8710163300481	15.4W, 1600lm, 4000K, DALI, aluminium reflector
DN292B15W3KDW	8710163300498	15.4W, 1600lm, 3000K, DALI, white reflector
DN292B15W4KDW	8710163300504	15.4W, 1600lm, 4000K, DALI, white reflector
DN293B22W3KFW	8710163300597	22.3W, 2300lm, 3000K, fixed output driver, white reflector
✓✓ DN293B22W4KFW	8710163300603	22.3W, 2300lm, 4000K, fixed output driver, white reflector
DN293B20W3KDA	8710163300511	20.8W, 2300lm, 3000K, DALI, aluminium reflector
DN293B20W4KDA	8710163300528	20.8W, 2300lm, 4000K, DALI, aluminium reflector
DN293B20W3KDW	8710163300535	20.8W, 2300lm, 3000K, DALI, white reflector
DN293B20W4KDW	8710163300542	20.8W, 2300lm, 4000K, DALI, white reflector
DN293B22W3KFWW	8710163300658	22.3W, 2300lm, 3000K, fixed output driver, IP54, white reflector
DN293B22W4KFWW	8710163300665	22.3W, 2300lm, 4000K, fixed output driver, IP54, white reflector

✓ product is IPART approved

✓ product is VEET approved

Get it right first time

Philips ClubBlue will:

- Guide you to the right solution for your job
- Let you search for products by application
- Provide detailed product information
- Keep you up-to-date with the latest in LED & connected lighting technology
- Show you current promotions

Designed for electricians.

Sign up today. It's free.



GreenSpace

Power downlight



Benefits

- Ideal replacement for 2x18W and 2x26W PLC
- Downlights suitable for high ceiling applications
 - up to 4500lm
- Significant system efficacy at up to 95lm/W

Family name	GreenSpace Power 2 LED Downlight	
Model	DN284B-8	DN285B-8
Cut-out	200-205mm	200-205mm
Replacement	2x18W PLC Downlights	2x26W PLC Downlights
Power	34W	41W
System lumen & Efficacy	3000K: 3450lm/ 101lm/W 4000K: 3650lm/ 107lm/W	3000K: 4250lm/ 104lm/W 4000K: 4500lm/ 110lm/W
Power factor	0.9	
CCT	3000K / 4000K	
CRI	>80	
Driver type	Fixed output	
Beam angle	100°	
SDCM	≤4	
Operating temperature	-20°C < ta < 40°C	
Lifetime (L70B50)*	50,000 hours	
IP rating	IP20	
UGR	≤24	
Mounting type	Recessed, fixed by spring tension clips	
Housing colour	White	
Material	Optics: MCPET high reflectance film, PMMA diffuser with high haze and light transmission Reflector: High purity aluminium, high reflectance coating Driver box: PC plastics Clips: Piano wire spring clip, PC plastic clip	

* When a new fitting reaches 70% of full potential

Dimensions

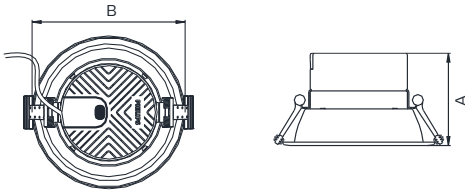

Model	Cut-out (mm)	Diameter/ B (mm)	Height/ A (mm)	Weight (kg)
DN284B-8	200-205mm	234	117	0.5
DN029B-3 LED8	200-205mm	234	117	0.5

Dimensions shown above are nominal measurement.
Slight variation in dimension may occur in production.

Order placement information

Order Code	Description
DN284B34WWFW	34W, 3450lm, 3000K, fixed output, 200mm cut-out
DN284B34WNFW	34W, 3450lm, 4000K, fixed output, 200mm cut-out
DN285B41WWFW	41W, 4250lm, 3000K, fixed output, 200mm cut-out
DN285B41WNFW	41W, 4250lm, 4000K, fixed output, 200mm cut-out

GreenSpace

Surface mounted downlight



Benefits

- Energy efficient (up to 100lm/W) solution compared to CFL/CDM equivalent
- Integrated design, lightweight and easy to install
- Multiple output options for various applications

Model	SM291C	SM293C	SM294C	SM295C	SM294C WP	SM295C WP	
Replacement	1x26W CFL	2x26W CFL/ 35W CDM	70W CDM	150W CDM	70W CDM	150W CDM	
Power	10W	20W	38W	66W	38W	66W	
System lumen & efficacy	3000K: 930lm/ 93lm/W	3000K: 1860lm/ 93lm/W	3000K: 3470lm/ 91lm/W	3000K: 6600lm/ 100lm/W	3000K: 3800lm/ 100lm/W	3000K: 6600lm/ 100lm/W	
	4000K: 1000lm/ 100lm/W	4000K: 2000lm/ 100lm/W	4000K: 3800lm/ 100lm/W	4000K: 6600lm/ 100lm/W	4000K: 3800lm/ 100lm/W	4000K: 6600lm/ 100lm/W	
	Beam angle	90°	90°	60°	60°	60°	60°
	IP Rating	IP20	IP20	IP20	IP20	IP65	IP65
CCT	3000K / 4000K						
CRI	> 80						
SDCM	< 5						
Operating temperature	-20°C < ta < 40°C						
Lifetime (L70B50)*	50,000 hours						
Type	Fixed Output						
UGR	≤ 24						
Power factor	> 0.90						
Electrical class	Class I						
Mounting type	Surface Mounted						
Housing colour	White						
Material	Optics: MCPET high reflectance film, PC diffuser with high haze and light transmission Reflector: High purity aluminium, high reflectance coating Front Housing: PC, Rear Housing: Aluminium						

* When a new fitting reaches 70% of full potential

Dimensions

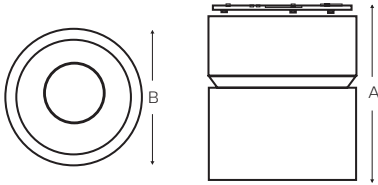

Model	Cut-out (mm)	Diameter/ B (mm)	Height/ A (mm)	Weight (kg)
SM291C LED10	200-205mm	160	135	0.6
SM293C LED20	200-205mm	160	135	0.6
SM294C LED40	200-205mm	160	170	0.8
SM295C LED70	200-205mm	200	239	2.2
SM294C LED40 WP	200-205mm	200	239	0.8
SM295C LED70 WP	200-205mm	200	239	2.2

Dimensions shown above are nominal measurement.
Slight variation in dimension may occur in production.

Order placement information

Order Code	Description
SM291C10WWFW	10W, 1000lm, 100lm/W, 3000K, fixed output
SM291C10WNFW	10W, 1000lm, 100lm/W, 4000K, fixed output
SM293C20WWFW	20W, 2000lm, 100lm/W, 3000K, fixed output
SM293C20WNFW	20W, 2000lm, 100lm/W, 4000K, fixed output
SM294C38WWFW	38W, 3800lm, 100lm/W, 3000K, fixed output
SM294C38WNFW	38W, 3800lm, 100lm/W, 4000K, fixed output
SM295C66WWFW	66W, 6600lm, 100lm/W, 3000K, fixed output
SM295C66WNFW	66W, 6600lm, 100lm/W, 4000K, fixed output
SM294C38WWFWP	38W, 34700lm, 91lm/W, 3000K, fixed output, IP65
SM294C38WNFWP	38W, 3800lm, 100lm/W, 4000K, fixed output, IP65
SM295C66WWFWP	66W, 6600lm, 100lm/W, 3000K, fixed output, IP65
SM295C66WNFWP	66W, 6600lm, 100lm/W, 4000K, fixed output, IP65

Essential

Slimline oyster



Benefits

- LED delivers longer life than conventional light sources with up to 15,000 hours
- 75% more energy efficient versus traditional light sources
- Stylish slimline design only 55mm thick for a clean, unobtrusive installation
- Available in 3 sizes and in IP65 for bathrooms

Model	Slimline Oyster Gen2			
Type	31814	31815	31816	31817
Power	12W	17W	20W	12W
System lumen	800lm	1100lm	1400lm	800lm
IP Rating	IP20	IP20	IP20	IP65
CCT	2700K (Warm White) and 6500K (Cool White)			
Lifetime (L70B50)*	15,000 hours			
Electrical Class	Class I			
Input Voltage	100 - 240V			
Mounting Type	Ceiling Mount			
Housing colour	White			
Material	Diffuser: Acrylic Housing: Synthetics			
Application	Residential, Commercial, Bathroom			

* When a new fitting reaches 70% of full potential

Dimensions

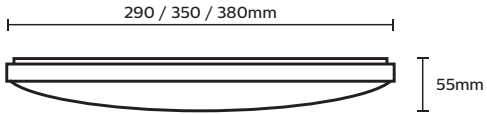

Dimensions shown above are nominal measurement.
Slight variation in dimension may occur in production.

Order placement information

Order Code	Description
3184OY65K12W	800lm, 12W, 6500K
3184OY27K12W	800lm, 12W, 2700K
31815OY65K17W	1100lm, 17W, 6500K
31815 OY27K17W	1100lm, 17W, 2700K
31816OY65K20W	1400lm, 20W, 6500K
31816OY27K20W	1400lm, 20W, 2700K
3187OY65K12WIP	800lm, 12W, 6500K, IP65
3187OY27K12WIP	800lm, 12W, 2700K, IP65

SmartBright

Slim panel



Benefits

- Energy efficient edge lit panel
- Comfortable light with minimal glare
- 3 years warranty

Model	SmartBright Slim Panel (RC091V)	
Type	LED26S	LED36S
Equivalent of	1x28W	2x28W
Power	34W	45W
System lumen	2600lm	3600lm
Power factor	0.9	
CCT	4000K (NW)	
CRI	>80	
SDCM	≤5	
UGR	25	
Beam Angle	90	
Operating Temperature	25°C (-20°C < ta < 40°C)	
Lifetime (L70B50)*	25,000 hours	
Type	Fixed Output	
IP rating	IP20	
Insulation Rating	CA90	
Electrical Class	Class II	
Input Voltage	220V-240V, 50/60Hz	
Mounting Type	Recessed (T-Bar), Suspended**	
Housing colour	White powder coated	
Material	Diffuser: PC Housing: Metal	
Application	Commercial buildings, general lighting	

* When a new fitting reaches 70% of full potential

** Suspension cable to be purchased separately

Dimensions

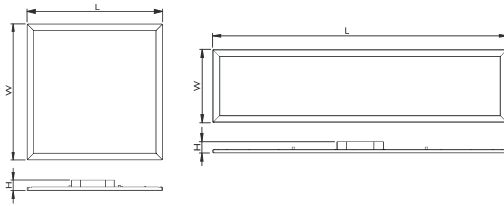

Model	Width (mm)	Length (mm)	Height (mm)	Weight (kg)
Rectangle	297	1197	41	2.3
Square	597	597	41	2.1

Dimensions shown above are nominal measurement.
Slight variation in dimension may occur in production.

Order placement information

Order Code	Description
SBSPLED26NWFsq	Recessed, 2600lm, 4000K, Fixed, 597x597mm
SBSPLED26NWFRE	Recessed, 2600lm, 4000K, Fixed, 297x1197mm
SBSPLED36NWFsq	Recessed, 3600lm, 4000K, Fixed, 597x597mm
SBSPLED36NWFRE	Recessed, 3600lm, 4000K, Fixed, 297x1197mm

Coreline

2.5



Benefits

- Affordable LED office compliant lighting
- High system efficacy of up to 112lm/w
- Comfortable light with minimal glare creates an improved working environment

Model type	RC100C (recessed) SM100C (surface mounted, suspended)	
Lumen	LED25S - 24W/2700lm LED35S - 37W/3900lm	
Power	24W LED25S	
UGR	Recessed 2700lm - UGR18(600x600), UGR20(300x1200) 3900lm - UGR19(600x600), UGR18(300x1200)	Surface Mounted/Suspended 2700lm - UGR18 (600x600), UGR20 (300x1200) 3900lm - UGR19 (600x600), UGR21 (300x1200)
Lifetime (L70B50)*	50,000 hours	
CCT	4000K	
CRI	80	
SDCM	≤4	
Power factor	0.9	
Operating temperature	25°C	
Optics	PMMA optical lens	
Driver	Integrated fixed driver (DALI version available on request)	
Installation	T-Bar and Plaster Recessed, Surface Mounted and Suspended**	
IP rating	IP20	
Material	Housing: SPCC (0.5mm), White powder coat finishing (RAL9016) Diffuser: PC, PMMA optical lens (for UGR19 option only)	
Colour	White	
Application	Commercial buildings, Open office, Cell office, Hospital	
Accessories	Suspension kit and Plaster recessed kit sold separately	

* When a new fitting reaches 70% of full potential

** Plaster trim kit to be purchased separately. Suspension kit sold separately and to be used on surface mounted version only.

Dimensions

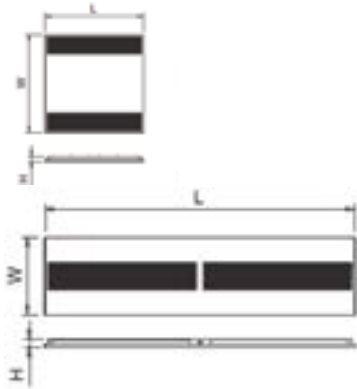

Model	Width/ A (mm)	Length/ C (mm)	Height/ B (mm)	Weight (kg)
RC100C - Rectangle	297	1197	30	2.8
RC100C - Square	597	597	30	2.8
SM100C - Rectangle	197	1197	36	3.7
RC100C - Square	597	597	36	4.4

Dimensions shown above are nominal measurement.
Slight variation in dimension may occur in production.

Order placement information

Order Code	Description
✓ RC100C24W4KFSQ	Recessed, 24W, 2700lm, 4000K, Fixed Output, 597x597mm, UGR18
✓ RC100C24W4KFREC	Recessed, 24W, 2700lm, 4000K, Fixed Output, 297x1197mm, UGR20
RC100C24W4KDSQ	Recessed, 24W, 2700lm, 4000K, DALI compatible, 597x597mm, UGR18
RC100C24W4KDREC	Recessed, 24W, 2700lm, 4000K, DALI compatible, 297x1197mm, UGR20
✓ RC100C37W4KFSQ	Recessed, 37W, 3900lm, 4000K, Fixed Output, 597x597mm, UGR19
✓✓ RC100C37W4KFREC	Recessed, 37W, 3900lm, 4000K, Fixed Output, 297x1197mm, UGR18
✓ RC100C37W4KDSQ	Recessed, 37W, 3900lm, 4000K, DALI compatible, 597x597mm, UGR19
✓ RC100C37W4KDREC	Recessed, 37W, 3900lm, 4000K, DALI compatible, 297x1197mm, UGR18
✓ RC100C37W4KDSQA	Recessed, 37W, 3900lm, 4000K, DALI compatible, 597x597mm, UGR19, integrated with Actilume controls
✓✓ RC100C37W4KDREA	Recessed, 37W, 3900lm, 4000K, DALI compatible, 297x1197mm, UGR18, integrated with Actilume controls
✓ SM100C24W4KFSQ	Surface Mounted, 24W, 2700lm, 4000K, Fixed Output, 597x597mm, UGR18
✓ SM100C24W4KFREC	Surface Mounted, 24W, 2700lm, 4000K, Fixed Output, 197x1197mm, UGR20
SM100C37W4KFSQ	Surface Mounted, 37W, 3900lm, 4000K, Fixed Output, 597x597mm, UGR19
SM100C37W4KFREC	Surface Mounted, 37W, 3900lm, 4000K, Fixed Output, 197x1197mm, UGR21
RC100CSUSPSET	Suspension set for SM100C

✓ product is IPART approved

✓ product is VEET approved

SmartPanel

3



Benefits

- Affordable LED office compliant lighting
- High system efficacy for edge lit panel – up to 95lm/w
- Comfortable light with minimal glare creates an improved working environment
- Reliable with up to 50,000 hours lifetime

Family name	SmartPanel 3.0 (RC160V)	
Model type	LED25S	LED34S
Equivalent of	1x28W	2x28W
Power	26W	36W
System lumen	2500lm	3400lm
Power factor	0.9	
CCT	4000K (NW)	
CRI	>80	
SDCM	≤4	
UGR	UGR21 and UGR19	
Beam angle	114° (UGR21)/ 88° (UGR19)	
Operating temperature	25°C (-20°C < ta < 40°C)	
Lifetime*	50,000 hours (L70B50), 30,000 hours (L80B50), 15,000 hours (L90B50)	
Type	Fixed output, DALI compatible	
IP rating	IP20	
Electrical class	Class II	
Input voltage	220V-240V, 50/60Hz	
Mounting type	Recessed (T-Bar), Suspended (kit included)	
Housing colour	White powder coated	
Material	Diffuser: PC Housing: Aluminium	
Application	Commercial buildings, Open office, Cell office, Hospital	

* When a new fitting reaches 70% of full potential

Dimensions

Model	Width (mm)	Length (mm)	Height (mm)	Weight (kg)
Recessed - Rectangle	297	1197	42.5	3.6
Recessed - Square	597	597	42.5	3.6
Suspended - Rectangle	297	1197	42.5	3.8
Suspended - Square	597	597	42.5	3.8

Dimensions shown above are nominal measurement.
Slight variation in dimension may occur in production.

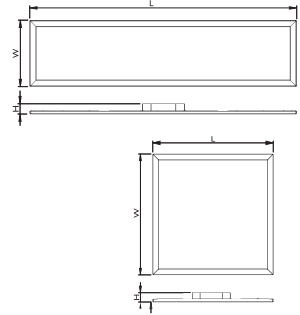

Order placement information

Commercial Code	Description
✓✓ SP3RC25LNWFSQ19	Recessed, 2500lm, 26W, 4000K, UGR19, Fixed output, 597mmx597mm
✓✓ SP3RC25LNWFRE19	Recessed, 2500lm, 26W, 4000K, UGR19, Fixed output, 297mmx1197mm
✓✓ SP3RC34LNWFSQ19	Recessed, 3400lm, 36W, 4000K, UGR19, Fixed output, 597mmx597mm
✓✓ SP3RC34LNWFRE19	Recessed, 3400lm, 36W, 4000K, UGR19, Fixed output, 297mmx1197mm
✓ SP3RC34LNWDSQ19	Recessed, 3400lm, 36W, 4000K, UGR19, DALI, 597mmx597mm
✓ SP3RC34LNWDRE19	Recessed, 3400lm, 36W, 4000K, UGR19, DALI, 297mmx1197mm
SP3RC25LNWFSQ21	Recessed, 2500lm, 26W, 4000K, UGR21, Fixed output, 597mmx597mm
SP3RC25LNWFRE21	Recessed, 2500lm, 26W, 4000K, UGR21, Fixed output, 297mmx1197mm
SP3RC34LNWFSQ21	Recessed, 3400lm, 36W, 4000K, UGR21, Fixed output, 597mmx597mm
SP3RC34LNWFRE21	Recessed, 3400lm, 36W, 4000K, UGR21, Fixed output, 297mmx1197mm
SP3SS25LNWFSQ21	Suspended, 2500lm, 26W, 4000K, UGR21, Fixed output, 597mmx597mm, suspension kit included
SP3SS25LNWFRE21	Suspended, 2500lm, 26W, 4000K, UGR21, Fixed output, 297mmx1197mm, suspension kit included
SP3SS34LNWFSQ21	Suspended, 3400lm, 36W, 4000K, UGR21, Fixed output, 597mmx597mm, suspension kit included
SP3SS34LNWFRE21	Suspended, 3400lm, 36W, 4000K, UGR21, Fixed output, 297mmx1197mm, suspension kit included
SP3SS34LNWDSQ21	Suspended, 3400lm, 36W, 4000K, UGR21, DALI, 597mmx597mm, suspension kit included
SP3SS34LNWDRE21	Suspended, 3400lm, 36W, 4000K, UGR21, DALI, 297mmx1197mm, suspension kit included

✓ product is IPART approved

✓ product is VEET approved

SmartBright Batten



Benefits

- Surface mount direct to ceiling, no visible brackets
- Multiple knock-out options, large terminal and through wiring possible
- Available in emergency option (Lithium-ion battery), AS2293 compliant
- 3 years warranty

Model	SmartBright Batten (BN008C)		
Type	LED20	LED40	LED40 Emergency
Equivalent of	2x18W	2x36W	2x36W
Power	20W	40W	44W
System lumen	2100lm	4100lm	4100lm
Type	Fixed output (PSU)		
Diffuser	Frosted diffuser		
Power factor	≥0.9		
Beam Angle	100° - 120°		
CCT	4000K (NW)/ 6500K (CW)		
CRI	>80		
SDCM	≤5		
Operating Temperature	25°C (-20°C < ta < 40°C)/ for Emergency version: 25°C (0°C < ta < 40°C)		
Lifetime (L70B50)*	30,000 hours		
IP/ IK rating	IP20/ IK03		
Electrical Class	Class I		
Input Voltage	220V-240V, 50/60Hz		
Mounting Type	Surface mount, install direct to ceiling, no visible brackets		
Surge Protection	LED20: Line to Line - 500V, Line to Ground - 1KV LED40/ LED40 EM: Line to Line - 1KV, Line to Ground - 2KV		
Housing colour	White (RAL9010)		
Material	Frosted cover: PC Housing: 0.6mm SPCC		
Emergency rating (EM)	AS2293 Compliant Duration: >3hours Wattage: 4-5W @ 400-500lm Classification: CO D80/ C90 D40		
Application	Warehouses, back of house areas, indoor car parks, factories		

* When a new fitting reaches 70% of full potential

Dimensions

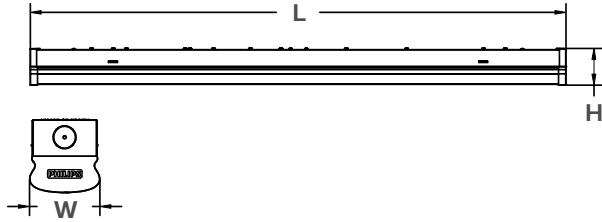

Model	Width (mm)	Length (mm)	Height (mm)	Weight (kg)
LED20	80	630	85	1.02
LED40	80	1230	85	1.86
LED40 EM	80	1230	85	2.22

Dimensions shown above are nominal measurement.
Slight variation in dimension may occur in production.

Order placement information

Order Code	Barcode	Description
SBWBLED20NW2FT	8710163315010	20W, 2100lm, 4000K, fixed output, 2ft
SBWBLED20CW2FT	8710163315027	20W, 2100lm, 6500K, fixed output, 2ft
SBWBLED40NW4FT	8710163315034	40W, 4100lm, 4000K, fixed output, 4ft
SBWBLED40CW4FT	8710163315041	40W, 4100lm, 6500K, fixed output, 4ft
SBWBLED40NW4FE	8710163315058	44W, 4100lm, 4000K, fixed output, Emergency, 4ft
SBWBLED40CW4FE	8710163315065	44W, 4100lm, 6500K, fixed output, Emergency, 4ft

SmartBright batten G2

Slim standalone



Benefits

- Ideal replacement for 1x36W and 1x18W T8 battens
- High system efficacy of up to 100lm/W
- Long lifetime with up to 25,000 hours @ L70
- Low maintenance

Model	SmartBright LED Batten Gen 2	
Description	BN012C (Standalone)	
Type	LED10	LED20
Equivalent of	1x18W	1x36W
Power	10W	20W
System lumen	1000lm	2000lm
Power factor	0.8	
Beam Angle	100° - 120°	
CCT	3000K (WW), 4000K (NW), 6500K (CW)	
CRI	>80	
SDCM	≤6	
Beam angle	120°	
Operating Temperature	25°C	
Lifetime (L70B50)*	25,000 hours	
Type	Fixed output	
IP rating	IP20	
Electrical Class	Class II	
Input Voltage	200V-240V, 50/60Hz	
Mounting Type	Surface Mounted (stainless steel brackets included)	
Housing colour	White	
Material	Diffuser: PC Housing: PC	
Application	Stairwells, back of house areas, garages	

* When new fitting reaches 70% of full potential

Dimensions

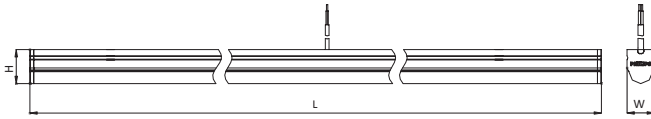

Model	Width (mm)	Length (mm)	Height (mm)	Weight (kg)
BN012C LED10	30	600	37	0.19
BN012C LED20	30	1200	37	0.29

Dimensions shown above are nominal measurement.
Slight variation in dimension may occur in production.

Order placement information

Order Code	Barcode	Description
SB22KLMWW4FTS	8710163308142	Standalone, 2000lm, 3000K, 1200mm length
SB22KLMNW4FTS	8710163308159	Standalone, 2000lm, 4000K, 1200mm length
SB22KLMCW4FTS	8710163308166	Standalone, 2000lm, 6500K, 1200mm length
SB21KLMWW2FTS	8710163308173	Standalone, 1000lm, 3000K, 600mm length
SB21KLMNW2FTS	8710163308180	Standalone, 1000lm, 4000K, 600mm length
SB21KLMCW2FTS	8710163308197	Standalone, 1000lm, 6500K, 600mm length

SmartBright batten G2

Slim trunkable



Benefits

- Ideal replacement for 1x36W and 1x18W T8 battens
- High system efficacy of up to 100lm/W
- Long lifetime with up to 25,000 hours @ L70
- Low maintenance

Model	SmartBright LED Batten Gen 2	
Description	BN013C (Trunkable) - max 10pcs per line	
Type	LED10	LED20
Equivalent of	1x18W	1x36W
Power	10W	20W
System lumen	1000lm	2000lm
Power factor	0.8	
Beam Angle	100° - 120°	
CCT	3000K (WW), 4000K (NW), 6500K (CW)	
CRI	>80	
SDCM	≤6	
Beam angle	120°	
Operating Temperature	25°C	
Lifetime (L70B50)*	25,000 hours	
Type	Fixed output	
IP rating	IP20	
Electrical Class	Class II	
Input Voltage	200V-240V, 50/60Hz	
Mounting Type	Surface Mounted (stainless steel brackets included)	
Housing colour	White	
Material	Diffuser: PC Housing: PC	
Accessories (Trunkable**)	1.2m flex with plug, 265mm connecting cable	
Application	Stairwells, back of house areas, garages	

* When new fitting reaches 70% of full potential

** For trunkable version only. To be purchased separately, not included in batten

Dimensions

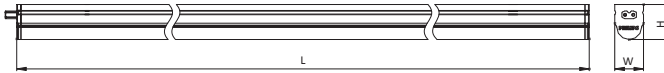

Model	Width (mm)	Length (mm)	Height (mm)	Weight (kg)
BN013C LED10	30	600	37	0.12
BN013C LED20	30	1200	37	0.24

Dimensions shown above are nominal measurement.
Slight variation in dimension may occur in production.

Order placement information

Order Code	Barcode	Description
SB22KLMWW4FTC	8710163308265	Trunkable, 2000lm, 3000K, 1200mm length
SB22KLMNW4FTC	8710163308272	Trunkable, 2000lm, 4000K, 1200mm length
SB22KLMCW4FTC	8710163308289	Trunkable, 2000lm, 6500K, 1200mm length
SB21KLMWW2FTC	8710163308296	Trunkable, 1000lm, 3000K, 600mm length
SB21KLMNW2FTC	8710163308302	Trunkable, 1000lm, 4000K, 600mm length
SB21KLMCW2FTC	8710163308319	Trunkable, 1000lm, 6500K, 600mm length
SB2ZCH086FP	8710163305165	Trunking accessory, 1.2m flex & plug
SB2ZCH086CC	8710163305172	Trunking accessory, 265mm connecting cable with male & female ends

CoreRange batten

Standalone



Benefits

- Ideal as a T8 batten replacement
- Integrated design, lightweight and easy to install
- Multiple output options for various applications

Family name	CoreRange LED Batten - Standalone (BN188C)					
Model type	BN188C LED10 L600	BN188C LED20 L600	BN188C LED20 L1200	BN188C LED40 L1200	BN188C LED30 L1500	BN188C LED60 L1500
Replacement of	1x18W	12x18W	1x36W	2x36W	1x58W	2x58W
Power	10W	22W	19W	37W	26W	54W
Lumen	1000lm	2100lm	2400lm	4000lm	3300lm	6000lm
Power factor	0.9	0.95	0.95	0.95	0.95	0.95
Beam angle	120°					
CCT	4000K (NW)					
CRI	>80					
SDCM	≤5					
Operating temperature	Ta:25°C (-20°C < ta < 40°C)					
Lifetime (L70B50)*	50,000 hours					
Type	Fixed Output					
IP rating	IP20					
Electrical class	Class I					
Input voltage	220V-240V, 50/60Hz					
Mounting type	Surface mount (brackets included), Suspended (accessories to be purchased separately)					
Housing colour	White (RAL9010)					
Material	Frosted cover: PMMA Housing: 0.6mm SPCC					
Mounting accessories	Surface mount brackets for asymmetric Installation, 2x pcs (BY208Z MB-A) Surface mount brackets for symmetric installation, 2x pcs (BY208Z MB-S) Suspension brackets for asymmetric Installation, 2x pcs (BY209Z MB-A) Suspension brackets for symmetric Installation, 2x pcs (BY209Z MB-S) Suspension pole 1.5m, 2x pcs (BY208Z SP) - suspension brackets required, please order separately					
Application	Warehouses, back of house areas, indoor car parks, factories					

* When new fitting reaches 70% of full potential

Dimensions

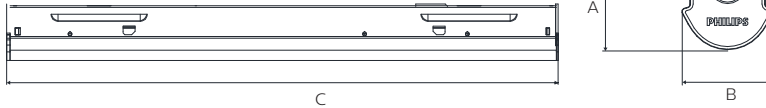

Model	Width/ B (mm)	Length/ C (mm)	Height/ A (mm)	Weight (kg)
BN188C LED10 L600	57	573	58	0.8
BN188C LED20 L600	57	573	58	0.8
BN188C LED20 L1200	57	1135	58	1.7
BN188C LED40 L1200	57	1135	58	1.7
BN188C LED30 L1500	57	1416	58	1.9
BN188C LED60 L1500	57	1416	58	1.9

Dimensions shown above are nominal measurement.
Slight variation in dimension may occur in production.

Order placement information

Order Code	Barcode	Description
✓✓ BN188C10WCW2F	8710163306131	10W, 1000lm, 6500K, Fixed output, Frosted cover, 573mm(L)x57mm(W)x58mm(H)
✓✓ BN188C10WNW2F	8710163306148	10W, 1000lm, 4000K, Fixed output, Frosted cover, 573mm(L)x57mm(W)x58mm(H)
✓✓ BN188C22WCW2F	8710163306155	22W, 2100lm, 6500K, Fixed output, Frosted cover, 573mm(L)x57mm(W)x58mm(H)
✓✓ BN188C22WNW2F	8710163306162	22W, 2100lm, 4000K, Fixed output, Frosted cover, 573mm(L)x57mm(W)x58mm(H)
✓✓ BN188C19WCW4F	8710163306179	19W, 2400lm, 6500K, Fixed output, Frosted cover, 1135mm(L)x57mm(W)x58mm(H)
✓✓ BN188C19WNW4F	8710163306186	19W, 2400lm, 4000K, Fixed output, Frosted cover, 1135mm(L)x57mm(W)x58mm(H)
✓✓ BN188C37WCW4F	8710163306193	37W, 4000lm, 6500K, Fixed output, Frosted cover, 1135mm(L)x57mm(W)x58mm(H)
✓✓ BN188C37WNW4F	8710163306209	37W, 4000lm, 4000K, Fixed output, Frosted cover, 1135mm(L)x57mm(W)x58mm(H)
BN188C26WCW5F	8710163306216	26W, 3300lm, 6500K, Fixed output, Frosted cover, 1416mm(L)x57mm(W)x58mm(H)
BN188C26WNW5F	8710163306223	26W, 3300lm, 4000K, Fixed output, Frosted cover, 1416mm(L)x57mm(W)x58mm(H)
BN188C54WCW5F	8710163306230	54W, 6000lm, 6500K, Fixed output, Frosted cover, 1416mm(L)x57mm(W)x58mm(H)
BN188C54WNW5F	8710163306247	54W, 6000lm, 4000K, Fixed output, Frosted cover, 1416mm(L)x57mm(W)x58mm(H)

✓ product is IPART approved

✓ product is VEET approved

CoreRange batten

Trunkable



Benefits

- Ideal as a T8 batten replacement
- Integrated design, lightweight and easy to install

Family name	CoreRange LED Batten - Trunkable (BN189C)			
Model type	BN189C LED20 L1200	BN189C LED40 L1200	BN189C LED30 L1500	BN189C LED60 L1500
Equivalent of	1x36W	2x36W	1x58W	2x58W
Power	19W	37W	26W	54W
Lumen	2400lm	4000lm	3300lm	6000lm
Power factor	0.95	0.95	0.95	0.95
Beam angle	120°			
CCT	4000K (NW)/ 6500K (CW)			
CRI	>80			
SDCM	≤5			
Operating temperature	Ta:25°C (-20°C < ta < 40°C)			
Lifetime (L70B50)*	50,000 hours			
Type	Fixed Output			
IP rating	IP20			
Electrical class	Class I			
Input voltage	220V-240V, 50/60Hz			
Mounting type	Surface mount (brackets included), Suspended (accessories to be purchased separately)			
Housing colour	White (RAL9010)			
Material	Frosted cover: PMMA Housing: 0.6mm SPCC			
Trunking accessories	Connection block (BY208Z TB) Connecting cable 0.6m (BY208Z C600-P) Connecting cable 0.2m (BY208Z C200-P) Power cable 0.2m (BY208Z C-2)			
Mounting accessories	Surface mount brackets for asymmetric Installation, 2x pcs (BY208Z MB-A) Surface mount brackets for symmetric installation, 2x pcs (BY208Z MB-S) Suspension brackets for asymmetric Installation, 2x pcs (BY209Z MB-A) Suspension brackets for symmetric Installation, 2x pcs (BY209Z MB-S) Suspension pole 1.5m, 2x pcs (BY208Z SP) - suspension brackets required, please order separately			
Application	Warehouses, back of house areas, indoor car parks, factories			

* When new fitting reaches 70% of full potential

Dimensions

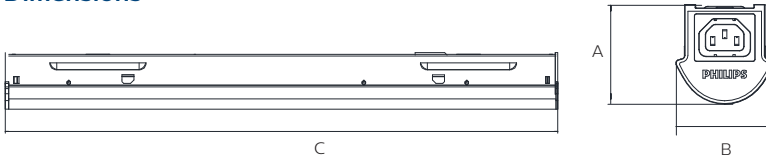

Model	Width/ B (mm)	Length/ C (mm)	Height/ A (mm)	Weight (kg)
BN189C LED20 L1200	58	1135	57	1.8
BN189C LED40 L1200	58	1135	57	1.8
BN189C LED30 L1500	58	1416	57	1.8
BN189C LED60 L1500	58	1416	57	1.8

Dimensions shown above are nominal measurement.
Slight variation in dimension may occur in production.

Order placement information

Order Code	Description
BN189C19WCW4F	19W, 2400lm, 6500K, Fixed output, Frosted cover, 1135mm(L)x57mm(W)x58mm(H)
BN189C19WNW4F	19W, 2400lm, 4000K, Fixed output, Frosted cover, 1135mm(L)x57mm(W)x58mm(H)
BN189C37WCW4F	37W, 4000lm, 6500K, Fixed output, Frosted cover, 1135mm(L)x57mm(W)x58mm(H)
BN189C37WNW4F	37W, 4000lm, 4000K, Fixed output, Frosted cover, 1135mm(L)x57mm(W)x58mm(H)
BN189C26WCW5F	26W, 3300lm, 6500K, Fixed output, Frosted cover, 1416mm(L)x57mm(W)x58mm(H)
BN189C26WNW5F	26W, 3300lm, 4000K, Fixed output, Frosted cover, 1416mm(L)x57mm(W)x58mm(H)
BN189C54WCW5F	54W, 6000lm, 6500K, Fixed output, Frosted cover, 1416mm(L)x57mm(W)x58mm(H)
BN189C54WNW5F	54W, 6000lm, 4000K, Fixed output, Frosted cover, 1416mm(L)x57mm(W)x58mm(H)

SmartBright wide Waterproof batten



Benefits

- Wider base for direct replacement of T8 battens
- Multiple knock-out options, large terminal and through wiring possible
- Available in emergency option (Lithium-ion battery), AS2293 compliant
- Ideal for indoor car parks, stair wells and industrial application
- 3 years warranty

Model	SmartBright Wide Waterproof Batten (WT008C)		
Type	LED20	LED40	LED40 Emergency
Equivalent of	2x18W	2x36W	2x36W
Power	20W	40W	44W
System lumen	2100lm	4100lm	4100lm
Type	Fixed output (PSU)		
Diffuser	Frosted diffuser		
Power factor	≥0.9		
Beam Angle	110° - 130°		
CCT	4000K (NW)/ 6500K (CW)		
CRI	>80		
SDCM	≤6		
Operating Temperature	25°C (-20°C < ta < 50°C)/ for Emergency version: 25°C (0°C < ta < 40°C)		
Lifetime (L70B50)*	50,000 hours		
IP/ IK rating	IP65/ IK08		
Electrical Class	Class I		
Input Voltage	220V-240V, 50/60Hz		
Mounting Type	Surface mount with brackets		
Surge Protection	LED20: Line to Line - 500V, Line to Ground - 1KV LED40/ LED40 EM: Line to Line - 1KV, Line to Ground - 2KV		
Housing colour	Light grey (RAL7035)		
Material	Frosted cover: PC Housing: PC		
Emergency rating (EM)	AS2293 Compliant Duration: >3hours Wattage: 4-5W @ 400-500lm Classification: CO D80/ C90 D50		
Application	Warehouses, back of house areas, indoor car parks, factories		

* When new fitting reaches 70% of full potential

Dimensions

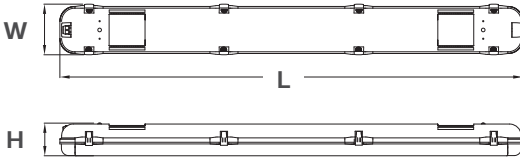

Model	Width (mm)	Length (mm)	Height (mm)	Weight (kg)
LED20	140	664	90	1.25
LED40	140	1274	90	2.15
LED40 EM	140	1274	90	2.45

Dimensions shown above are nominal measurement.
Slight variation in dimension may occur in production.

Order placement information

Order Code	Barcode	Description
SBWPLED20NW2FT	8710163315072	20W, 2100lm, 4000K, fixed output, 2ft
SBWPLED20CW2FT	8710163315089	20W, 2100lm, 6500K, fixed output, 2ft
SBWPLED40NW4FT	8710163315096	40W, 4100lm, 4000K, fixed output, 4ft
SBWPLED40CW4FT	8710163315102	40W, 4100lm, 6500K, fixed output, 4ft
SBWPLED40NW4FE	8710163315119	44W, 4100lm, 4000K, fixed output, Emergency, 4ft
SBWPLED40CW4FE	8710163315126	44W, 4100lm, 6500K, fixed output, Emergency, 4ft

SmartBright G2

Waterproof batten



Benefits

- Robust, clip-less design
- Easy and quick installation
- Excellent performance
- Breather valve for enhanced moisture-proof performance IP65

Model	WT066C			
Type	LED9	LED18	LED336	LED45
Power	9W	19W	40W	49W
System lumen	900lm	1800lm	3600lm	4500lm
Power factor	0.9			
CCT	4000K (NW)			
CRI	>80			
SDCM	<5			
Operating Temperature	-30°C to + 45°C			
Lifetime (L70B50)*	25,000 hours			
IP/IK rating	IP65, IK06			
Electrical Class	Class II			
Input Voltage	220V-240V, 50/60Hz			
Mounting Type	Surface/Wall mounted			
Housing colour	Grey			
Material	UV stabilised PC housing, dual extrusion technology			
Application	Garages, Indoor parking, Industrial applications			

* When new fitting reaches 70% of full potential

Dimensions

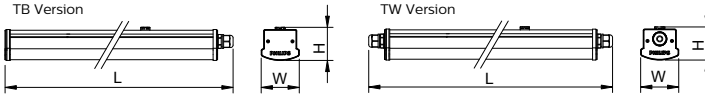

Model	Width/ W (mm)	Length/ L (mm)	Height/ H (mm)
L600 TB	68	626	60
L600 TW	68	654	60
L1200 TB	68	1226	60
L1200 TW	68	1254	60
L1500 TB	68	1526	60
L1500 TW	68	1554	60

Dimensions shown above are nominal measurement.
Slight variation in dimension may occur in production.

Order placement information

Order Code	Description
For individual installation:	
WT066C94K60TB	9W, 900lm, 4000K, 600mm, Fixed Output, for individual installation
WT066C184K60TB	19W, 1800lm, 4000K, 600mm, Fixed Output, for individual installation
WT066C184K120TB	19W, 1800lm, 4000K, 1200mm, Fixed Output, for individual installation
WT066C364K120TB	40W, 3600lm, 4000K, 1200mm, Fixed Output, for individual installation
WT066C454K150TB	49W, 4500lm, 4000K, 1500mm, Fixed Output, for individual installation
Through wiring version:	
WT066C94K60TW	9W, 900lm, 4000K, 600mm, Fixed Output, through wiring version
WT066C184K60TW	19W, 1800lm, 4000K, 600mm, Fixed Output, through wiring version
WT066C184K120TW	19W, 1800lm, 4000K, 1200mm, Fixed Output, through wiring version
WT066C364K120TW	40W, 3600lm, 4000K, 1200mm, Fixed Output, through wiring version
WT066C454K150TW	49W, 4500lm, 4000K, 1500mm, Fixed Output, through wiring version

Coreline

Waterproof batten



Benefits

- Reliable LED technology – low maintenance
- Sleek design to create traditional look and feel
- Wide-beam light distribution



Model	WT120C				
Type	LED18S	LED22S	LED34S	LED40S	LED60S
Power	19W	23W	29W	41W	57W
System lumen	1800lm	2200lm	3400lm	4000lm	6000lm
Power factor	0.9				
CCT	4000K (NW)				
CRI	>80				
SDCM	<3.5				
UGR	UGR23				
Operating Temperature	-20°C to + 35°C				
Lifetime (L70B50)*	50,000 hours				
IP/IK rating	IP65, IK08				
Electrical Class	Class I				
Input Voltage	200V-240V, 50/60Hz				
Mounting Type	Surface/Wall mounted				
Housing colour	Grey				
Material	UV resistant PC body and diffuser				
Application	Garages, Indoor parking, Industrial applications				

* When new fitting reaches 70% of full potential

Dimensions

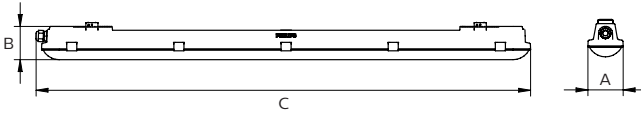

Model	Width (mm)	Length (mm)	Height (mm)
19W	87	661	82
23W/41W	87	1223	82
29W/57W	87	1523	82

Dimensions shown above are nominal measurement.
Slight variation in dimension may occur in production.

Order placement information

Order Code	Barcode	Description
WT120C19W4K600	8718291840459	19W, 1800lm, 4000K, Fixed output, frosted cover
✓✓ WT120C23W4K1200	8718291840466	23W, 2200lm, 4000K, Fixed output, frosted cover
WT120C29W4K1500	8718291840473	29W, 3400lm, 4000K, Fixed output, frosted cover
✓✓ WT120C41W4K1200	8718291840480	41W, 4000lm, 4000K, Fixed output, frosted cover
WT120C57W4K1500	8718291840497	57W, 6000lm, 4000K, Fixed output, frosted cover

✓ product is IPART approved

✓ product is VEET approved

Vandalite LED

Vandal-proof batten



Benefits

- Robust design and vandal-proofness
- Reliable system performance
- Comfortable light quality
- Breather valve for enhanced moisture-proof performance IP65

Model	BCW098	
Type	LED20	LED40
Power	19W	38W
System lumen	2000lm	4000lm
Power factor	0.9	
CCT	4000K (NW)	
CRI	>80	
SDCM	≤5	
UGR	UGR25	
Operating Temperature	-20°C to + 45°C	
Lifetime (L70B50)*	50,000 hours	
IP/IK rating	IP65, IK10	
Electrical Class	Class I	
Input Voltage	200V-240V, 50/60Hz	
Mounting Type	Surface/Wall mounted	
Housing colour	Grey	
Material	UV resistant PC body and diffuser, UL Yellow Card certificate F1	
Application	Residential areas, Security lighting, Garages, Indoor parking, Industrial applications	

* When new fitting reaches 70% of full potential

Dimensions

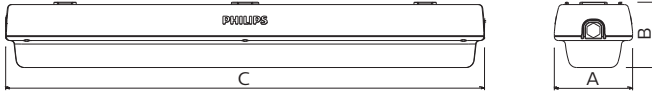

Model	Width/ A (mm)	Length/ C (mm)	Height/ B (mm)
BCW098 LED20	100	617	85
BCW098 LED40	100	1169	85

Dimensions shown above are nominal measurement.
Slight variation in dimension may occur in production.

Order placement information

Order Code	Description
✓✓ BCW098L204KF600	19W, 2000lm, 4000K, 600mm, fixed output
BCW098L404KF120	38W, 4000lm, 4000K, 1200mm, fixed output
BCW098L404KD120	38W, 4000lm, 4000K, 1200mm, DALI dimmable

- ✓ product is IPART approved
- ✓ product is VEET approved

GreenUp Highbay



Benefits

- Reliability and long lifetime
- Ideal replacement for HID high-bays
- Various light distributions to suit most applications
- Comfortable light with low glare and accurate colour

Model	BY550P		
Type	LED100	LED140	LED200
Power	80W	105W	160W
System lumen	10500lm	13650lm	21000lm
Power factor	0.9		
CCT	4000K (NW), 6500k (CW) available on request		
CRI	>85		
SDCM	<3.5		
Light distribution	WB Wide Beam, NB Narrow Beam, HRO High Rack Optic		
Operating Temperature	-20°C to + 40°C		
Lifetime (L70B50)*	70,000 hours		
Controls	DALI and Actilume Wireless Control versions available		
IP rating	IP20		
Electrical Class	Class I		
Input Voltage	220V-240V, 50/60Hz		
Mounting Type	Suspended		
Housing colour	White with silver end caps		
Material	Sheet metal and PC end caps		
Application	Warehouses, distribution centres, manufacturing		

* When a new fitting reaches 70% of full potential

Dimensions

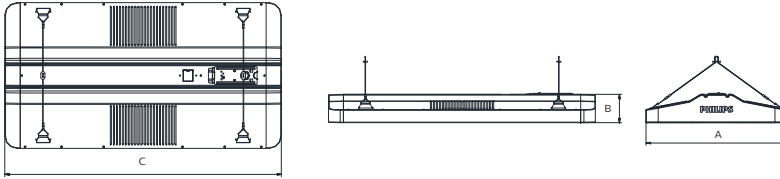

Model	Width/ A (mm)	Length/ C (mm)	Height/ B (mm)
BY550P LED200	380	720	77
BY550P LED140	380	720	77
BY550P LED100	380	440	77

Dimensions shown above are nominal measurement.
Slight variation in dimension may occur in production.

Order placement information

Order Code	Description
BY550P80W4KFNB	80W, 10500lm, 4000K, Fixed Output, Narrow Beam
✓✓ BY550P80W4KFWB	80W, 10500lm, 4000K, Fixed Output, Wide Beam
✓✓ BY550P80W4KFHR	80W, 10500lm, 4000K, Fixed Output, High Rack Optic
BY550P110W4KFNB	105W, 13650lm, 4000K, Fixed Output, Narrow Beam
✓✓ BY550P110W4KFWB	105W, 13650lm, 4000K, Fixed Output, Wide Beam
✓✓ BY550P110W4KFHR	105W, 13650lm, 4000K, Fixed Output, High Rack Optic
BY550P160W4KFNB	160W, 21000lm, 4000K, Fixed Output, Narrow Beam
✓✓ BY550P160W4KFWB	160W, 21000lm, 4000K, Fixed Output, Wide Beam
BY550P160W4KFHR	160W, 21000lm, 4000K, Fixed Output, High Rack Optic

More versions available, please contact your Philips sales representative for further information.

- ✓ product is IPART approved
- ✓ product is VEET approved

GreenPerform

Highbay G3



Benefits

- System efficacy of 130lm/W
- Superb light quality
- Safe and reliable – IP65/IK07 rating
- Lifetime of 50,000 hours at L70B50

Model	BY698P			
Type	LED110	LED160	LED200	LED300
Power	85W	120W	155W	225W
System lumen	11000lm	16000lm	20000lm	29000lm
Power factor	0.95			
CCT	4000K (NW), 6500k (CW) available on request			
CRI	>80			
SDCM	<5			
Light distribution	WB Wide Beam, NB Narrow Beam, ENB Extreme Narrow Beam			
Operating Temperature	-30°C to + 50°C			
Lifetime (L70B50)*	50,000 hours			
Controls	DALI, PIR and Actilume Wireless Control versions available			
IP/IK rating	IP65/IK07			
Electrical Class	Class I			
Input Voltage	220V-240V, 50/60Hz			
Mounting Type	Chain hook included, mounting brackets to be ordered separately			
Housing colour	Dark Grey Pantone 8405C			
Material	Aluminium diecast housing, PC lens			
Application	Production areas, warehouses and general open spaces			

* When a new fitting reaches 70% of full potential

Dimensions

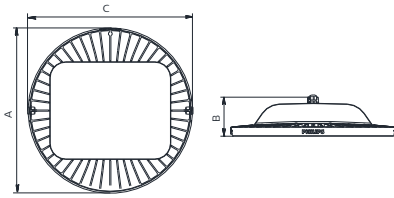

Model	Width/ A (mm)	Length/ C (mm)	Height/ B (mm)
BY698P LED110	382	379	96
BY698P LED160	418	417	105
BY698P LED200	454	452	107
BY698P LED300	534	530	120

Dimensions shown above are nominal measurement.
Slight variation in dimension may occur in production.

Order placement information

Order Code	Description
✓✓ BY698P110L4KFW	GreenPerform Highbay G3, 85W, 11000lm, 4000K, Fixed Output, Wide Beam, 3m Flex Cable
✓ BY698P110L4KFN	GreenPerform Highbay G3, 85W, 11000lm, 4000K, Fixed Output, Narrow Beam, 3m Flex Cable
✓✓ BY698P160L4KFW	GreenPerform Highbay G3, 120W, 16000lm, 4000K, Fixed Output, Wide Beam, 3m Flex Cable
✓ BY698P160L4KFN	GreenPerform Highbay G3, 120W, 16000lm, 4000K, Fixed Output, Narrow Beam, 3m Flex Cable
✓✓ BY698P200L4KFW	GreenPerform Highbay G3, 155W, 20000lm, 4000K, Fixed Output, Wide Beam, 3m Flex Cable
✓ BY698P200L4KFN	GreenPerform Highbay G3, 155W, 20000lm, 4000K, Fixed Output, Narrow Beam, 3m Flex Cable
BY698P300L4KFW	GreenPerform Highbay G3, 225W, 29000lm, 4000K, Fixed Output, Wide Beam, 3m Flex Cable
BY698P300L4KFN	GreenPerform Highbay G3, 225W, 29000lm, 4000K, Fixed Output, Extern Narrow Beam, 3m Flex Cable
BY698P300L4KFN	GreenPerform Highbay G3, 225W, 29000lm, 4000K, Fixed Output, Narrow Beam, 3m Flex Cable

More versions available, please contact your Philips sales representative for further information.

GreenUp

Lowbay G2



Benefits

- Comfortable light quality
- Contemporary design
- PIR option
- Easy installation and retrofitting

Model	BY288P		
Type	LED40	LED60	LED90
Power	30W	50W	75W
System lumen	3600lm	5900lm	8800lm
Power factor	0.95		
CCT	4000K (NW)		
CRI	>80		
SDCM	<5		
UGR	UGR17 (with reflector)		
Light distribution	Wide Beam, Narrow Beam with reflector		
Operating Temperature	-20°C to + 45°C		
Lifetime (L70B50)*	50,000 hours		
Controls	PIR version available		
IP rating	IP20		
Electrical Class	Class I		
Input Voltage	220V-240V, 50/60Hz		
Mounting Type	Chain hook included, optional		
Housing colour	Grey Pantone 429U		
Material	PC housing and diffuser, aluminium heat sync		
Application	Retail stores, warehouses and general open spaces		

* When a new fitting reaches 70% of full potential

Dimensions

LED60/90:

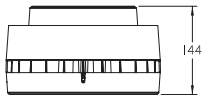
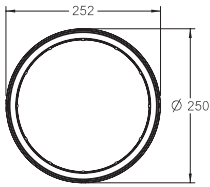

LED40:

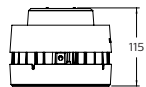
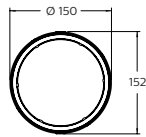

Dimensions shown above are nominal measurement. Slight variation in dimension may occur in production.

Order placement information

Order Code	Description
BY288P75W4KF	75W, 4000K, 9000 lumen, fixed output, 1,5m flex
BY288P50W4KF	50W, 4000K, 6000 lumen, fixed output, 1,5m flex
BY288P30W4KF	30W, 4000K, 3600 lumen, fixed output, 1,5m flex
BY288P75W4KR	75W, 4000K, 9000 lumen, for PIR sensor, 1,5m flex
BY288PPIR	PIR sensor kit (to be used with 911401843299 only)
BY268ZRL	Reflector for BY288P LED90 & LED60
BY269ZRL	Reflector for BY288P LED30
BY268ZMB	Mounting bracket for BY288P LED90 & LED60
BY269ZMB	Mounting bracket for BY288P LED30
BY268ZSMC	Chain kit
BY268ZSMP	Pipe kit

Essential SmartBright Floodlight



Benefits

- Long lasting performance
- Pressure die-cast housing offers excellent corrosion-resistance and robustness
- 600mm flying lead for ease of installation

Model	BVP161			
Type	LED26	LED43	LED60	LED90
Power	30W	50W	70W	100W
System lumen	2600lm	4300lm	6000lm	9000lm
Power factor	0.95			
CCT	4000K (NW)			
CRI	70			
SDCM	<5			
Light distribution	Wide beam			
Operating Temperature	-30°C to + 45°C			
Lifetime (L70B50)*	30,000 hours			
IP/IK rating	IP65/IK07			
Electrical Class	Class I			
Input Voltage	220V-240V, 50/60Hz			
Mounting Type	Adjustable bracket			
Housing colour	Grey RAL9007			
Material	Diecast aluminium			
Application	Billboards, amenity lighting, parking areas			

* When a new fitting reaches 70% of full potential

Dimensions

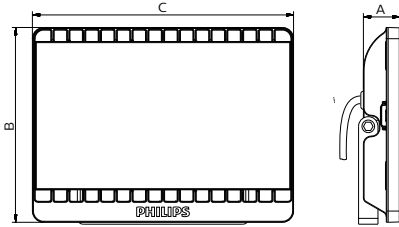

Model	Width/ C (mm)	Depth/ A (mm)	Height/ B (mm)
30W	194	34	143
50W	270	38	202
70W/100W	234	41	234

Dimensions shown above are nominal measurement.
Slight variation in dimension may occur in production.

Order placement information

Order Code	Description
BVP1614K30WGRY	30W, 2600lm, 4000k, wide beam
BVP1614K50WGRY	50W, 4300lm, 4000k, wide beam
BVP1614K70WGRY	70W, 6000lm, 4000k, wide beam
BVP1614K100WGRY	100W, 9000lm, 4000k, wide beam

Tango LED

Flood G3



Benefits

- Optical beam choices to suit most lighting applications
- 1:1 retrofit / HID replacement
- Elegant and unobtrusive design, robust and reliable (IP66/IK08)
- Temperature range up to 50°C Outdoor

Model	BVP381	BVP381	BVP382
Type	LED84	LED120	LED240
Power	70W	100W	200W
System lumen	8400lm	12000lm	24000lm
Power factor	0.95		
CCT	4000K NW (CW and WW on request)		
CRI	70		
SDCM	<7		
Light distribution	AMB Asymmetrical medium beam, AWB Asymmetrical wide beam, SWB Symmetrical wide beam		
Operating Temperature	-40°C to + 50°C		
Lifetime (L70B50)*	50,000 hours		
IP/IK rating	IP66/IK08		
Electrical Class	Class I		
Input Voltage	220V-240V, 50/60Hz		
Mounting Type	Adjustable bracket with aiming angle scale, 1.5 metre flying lead		
Housing colour	Grey RAL9007		
Material	Non-corrosive high pressure aluminium diecast with special powder coating		
Application	Area lighting, ports, airports, billboards, amenity lighting, facades		

* When a new fitting reaches 70% of full potential

Dimensions

BVP381:

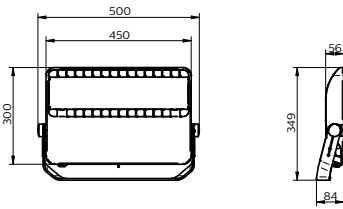

BVP382:

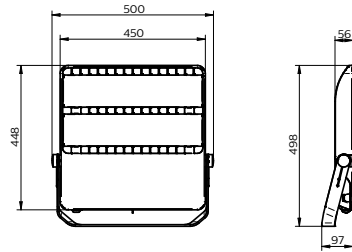

Dimensions shown above are nominal measurement.
Slight variation in dimension may occur in production.

Order placement information

Order Code	Description
BVP381844KSWBT	70W, 8400lm, 4000K, Symmetrical Wide Beam, Colour Packaging (Trade packaging)
BVP3811204KSWBT	100W, 12000lm, 4000K, Symmetrical Wide Beam, Colour Packaging (Trade packaging)
BVP3822404KSWBT	200W, 24000lm, 4000K, Symmetrical Wide Beam, Colour Packaging (Trade packaging)

More versions, including a high power BVP383, available, please contact your Philips sales representative for further information.

StreetStar

Benefits

- Optimal light quality that outperforms current HID and fluorescent luminaires
- High system efficacy of up to 115lm/w
- Reliable performance to ensure durability and functionality
- Easy to install with a compact design, long lasting, low maintenance and cost effective



Model	StreetStar - BRP210
Type	LED35
Equivalent of	1x80W MV
Power	27W
System lumen	3500lm
Power factor	0.95
CCT	4000K (NW)
CRI	>75
SDCM	≤5
UGR	N/A
Beam Angle	Wide Distribution (DW3)
Operating Temperature	35°C
Lifetime (L70B50)*	50,000 hours
IP rating	IP66
Electrical Class	Class I
IK protection	IK08
Input Voltage	220V-240V, 50/60Hz
Mounting Type	Side Entry; pole 42-60mm diameter with power input cable (0.5m) and connector assembly included (IP66)
Housing colour	Light Grey powder coated (RAL7040)
Material	Diffuser: Tarflon UV resistance plastic cover Housing: Die Cast Aluminium (ADC1)
Application	Low lumen package Road and Streets, Pathways, Pedestrian Access Ways

* When a new fitting reaches 70% of full potential

Dimensions

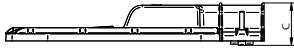
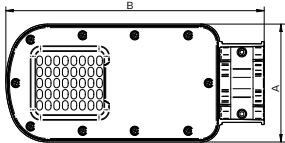

Model	Width/ A (mm)	Length/ B (mm)	Height/ C (mm)	Weight (kg)
BRP210	159	347	57	1.1

Dimensions shown above are nominal measurement.
Slight variation in dimension may occur in production.

Order placement information

Order Code	Description
BRP210354KDW3	StreetStar 3500lm, 27W, 4000K, DW3 Optic

Metro LED



Benefits

- Up to 70% energy savings compared to 70W High Pressure Sodium Lamp
- Solid die-cast housing for long fixture lifetime, excellent thermal management
- Vibration, dust and heat resistant
- High quality neutral white light with high colour consistency

Model	Metro Led - BGS007
Type	16xLED
Equivalent of	1x70W HPS
Power	20W
System lumen	2000lm
Power factor	0.9
CCT	4000K (NW)
CRI	>70
SDCM	≤5
Beam Angle	Symmetrical Beam WIDE
Operating Temperature	-40°C to +55°C
Lifetime (L70B50)*	50,000 hours
IP rating	IP65
Electrical Class	Class I; 10KV surge Protection
IK protection	IK06
Input Voltage	220V-240V, 50/60Hz
Mounting Type	Side Entry: pole 34mm diameter. A standard mounting bracket is supplied for mounting flexibility
Housing colour	Light Grey powder coated (RAL7040)
Material	Diffuser: Polycarbonate Housing: Die Cast Aluminium (ADC1)
Application	General Mining Areas, Conveyor Belts, Small Roads

* When a new fitting reaches 70% of full potential

Dimensions

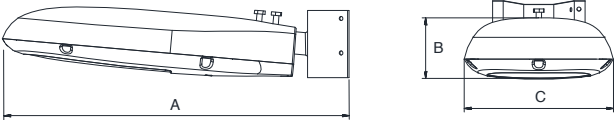

Model	Width/ C (mm)	Length/ A (mm)	Height/ B (mm)	Weight (kg)
BGS007	223	515	90	3.5

Dimensions shown above are nominal measurement.
Slight variation in dimension may occur in production.

Order placement information

Order Code	Description
BGS007204KS	2000lm, 20W, 4000K, DW Optic

SmartBright LED

Security light



Benefits

- Wide detection range and brighter light output
- PIR motion sensor activated with manual overwrite option for flexibility
- Easy to install with adjustable twin head
- 3 years warranty

Model	SmartBright LED Security Light (BWS220)
Type	LED20
Equivalent of	2x26W CFLi
System lumen	2000lm
Power	2x15W
Type	Fixed output (PSU)
Diffuser	Frosted diffuser
Power factor	≥0.9
CCT	4000K (NW)
CRI	>80
Operating Temperature	25°C (-20°C < ta < 40°C)
Lifetime (L70B50)*	30,000 hours
IP/ IK rating	IP54/ IK05
Electrical Class	Class I
Input Voltage	240V, 50/60Hz
Mounting Type	Wall mounted, rear wiring
Housing colour	Black (RAL9004)
Material	Frosted cover: UV-resistant Polycarbonate Housing: Plastic and die-cast aluminium twin head
Detection angle	120°
Detection range	Up to 18m (distance) at 2m (height of installation)
Day/night lux levels	3 to 2000 lux
Time range (ie: lights on)	10 seconds to 7 minutes

* When a new fitting reaches 70% of full potential

Dimensions

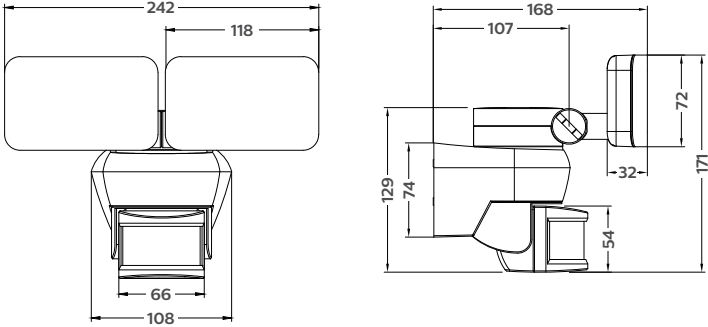

Dimensions shown above are nominal measurement. Slight variation in dimension may occur in production.

Order placement information

Order Code	Barcode	Description
SBSLLED20NWF	8710163315256	2x15W, 2000lm, 4000K, fixed output, Adjustable twin head

Smart LED Bollard



Benefits

- Reliable robust design, easy to install and maintenance free
- Environmentally friendly, no mercury or lead, with low power white LED light source
- Integrated baseplate and driver for easy installation
- 25,000 hours lifetime, IP65 and IK10

Model	Smart Bollard - BCP151/BCP150
Type	96xLED-LP
Equivalent of	50W Halogen/18W CFL
Power	8W
System lumen	300lm (WW)/ 400lm (NW)
Power factor	0.9
CCT	3000K (WW)/ 4000K (NW)
CRI	>70
SDCM	≤5
UGR	N/A
Beam Angle	Symmetrical
Operating Temperature	-20°C to +40°C
Lifetime (L70B50)*	25,000 hours
IP rating	IP65
Electrical Class	Class I; 10KV surge Protection
IK protection	IK10
Input Voltage	220V-240V, 50/60Hz
Mounting Type	On ground surface mounting, 4 x M8 bolts (not included)
Housing colour	Dark Grey powder coated (RAL7043)/ Light Grey powder coated (RAL9006)
Material	Diffuser: Polycarbonate Housing: Aluminium (ADC1)
Application	Landscaping, Parks and Gardens, Squares, Plazas, Residential Areas

* When a new fitting reaches 70% of full potential

Dimensions

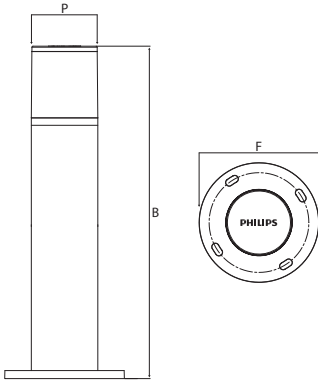

Model	Pole Diameter/ P (mm)	Flange Diameter/ F (mm)	Height/ B (mm)	Weight (kg)
BCP150	100	180	500	1.35
BCP151	100	180	800	1.85

Dimensions shown above are nominal measurement.
Slight variation in dimension may occur in production.

Order placement information

Order Code	Description
BCP150L44K7043	Smart Bollard, 500mm, 4000K, 424lm, Dark Grey
BCP151L44K7043	Smart Bollard, 800mm, 4000K, 424lm, Dark Grey

Smartbright

Bulkhead



Benefits

- Bright and energy efficient
- Optional knock-out, large terminal
- IP65 rated suitable for outdoor use
- 3 year warranty

Model	SmartBright Bulkhead (WL008C)
Type	LED10
Equivalent of	1x26W CFLi
Power	15W
System lumen	1000lm
Type	Fixed output (PSU)
Diffuser	Frosted diffuser
Power factor	≥0.9
Beam Angle	110°
CCT	4000K (NW)
CRI	>70
SDCM	≤6
Operating Temperature	25°C (-20°C < ta < 40°C)
Lifetime (L70B50)*	30,000 hours
IP/ IK rating	IP65/ IK06
Electrical Class	Class II
Input Voltage	220V-240V, 50/60Hz
Mounting Type	Surface mount
Housing colour	White
Accessory	Silver trim (in the box)
Material	Frosted cover: Polycarbonate Housing: Polycarbonate Trim: ABS
Application	Residential, back of house areas, walk-ways

* When a new fitting reaches 70% of full potential

Dimensions

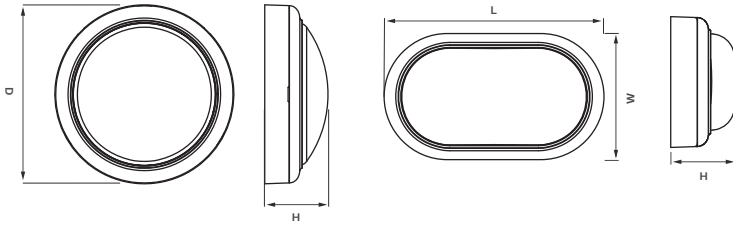

Model	Diameter/ D (mm)	Width/ W (mm)	Length/ L (mm)	Height/ H (mm)
Oval	-	133	223	68
Round	182	-	-	68

Dimensions shown above are nominal measurement.
Slight variation in dimension may occur in production.

Order placement information

Order Code	Barcode	Description
SBBLED10NWFOV	8710163315812	15W, 1000lm, 4000K, fixed output, oval
SBBLED10NWFRD	8710163315836	15W, 1000lm, 4000K, fixed output, round



LED lamps

Upgrade to LED by simply replacing your current conventional lamps with long lasting, energy-efficient LED lamps.



LED Bulb

- Ideal retro fit lamps for general lighting applications with excellent reliability
- Radiates warm or cool light in all directions, making it the perfect replacement to incandescent lamps
- Full range of outputs and base caps available

Order code	Description	LED	Traditional
LB470LA60WWES	LEDBulb 5-32W E27 3000K 230V A60 AU	5W	32W
LB470LA60CDLES	LEDBulb 5-32W E27 6500K 230V A60 AU	5W	32W
LB470LA60WWBC	LEDBulb 5-32W B22 3000K 230V A60 AU	5W	32W
LB470LA60CDLBC	LEDBulb 5-32W B22 6500K 230V A60 AU	5W	32W
LB600LA60WWES	LEDBulb 6.5-40W E27 3000K 230V A60 AU	6.5W	40W
LB600LA60CDLES	LEDBulb 6.5-40W E27 6500K 230V A60 AU	6.5W	40W
LB600LA60WWBC	LEDBulb 6.5-40W B22 3000K 230V A60 AU	6.5W	40W
LB600LA60CDLBC	LEDBulb 6.5-40W B22 6500K 230V A60 AU	6.5W	40W
LB806LA60WWES	LEDBulb 8-60W E27 3000K 230V A60 AU	8W	60W
LB806LA60CDLES	LEDBulb 8-60W E27 6500K 230V A60 AU	8W	60W
LB806LA60WWBC	LEDBulb 8-60W B22 3000K 230V A60 AU	8W	60W
LB806LA60CDLBC	LEDBulb 8-60W B22 6500K 230V A60 AU	8W	60W
LB1055LWA60WWES	LEDBulb 10.5-75W E27 3000K 230V A60 AU	10.5W	75W
LB1055LA60CDLES	LEDBulb 10.5-75W E27 6500K 230V A60 AU	10.5W	75W
LB1055LA60WWBC	LEDBulb 10.5-75W B22 3000K 230V A60 AU	10.5W	75W
LB1055LA60CDLBC	LEDBulb 10.5-75W B22 6500K 230V A60 AU	10.5W	75W
LB1400LA60WWES	LEDBulb 13-90W E27 3000K 230V A60 AU	13W	90W
LB1400LA60CDLES	LEDBulb 13-90W E27 6500K 230V A60 AU	13W	90W
LB1400LA60WWBC	LEDBulb 13-90W B22 3000K 230V A60 AU	13W	90W
LB1400LA60CDLBC	LEDBulb 13-90W B22 6500K 230V A60 AU	13W	90W



Save up to	Lifetime	Dimmable	Lumen output	Efficacy	Colour temp.	CRI
84%	15,000 hrs	No	470lm	94lm/W	3000 K	80
84%	15,000 hrs	No	470lm	94lm/W	6500 K	80
84%	15,000 hrs	No	470lm	94lm/W	3000 K	80
84%	15,000 hrs	No	470lm	94lm/W	6500 K	80
84%	15,000 hrs	No	600lm	92lm/W	3000 K	80
84%	15,000 hrs	No	600lm	92lm/W	6500 K	80
84%	15,000 hrs	No	600lm	92lm/W	3000 K	80
84%	15,000 hrs	No	600lm	92lm/W	6500 K	80
87%	15,000 hrs	No	806lm	101lm/W	3000 K	80
87%	15,000 hrs	No	806lm	101lm/W	6500 K	80
87%	15,000 hrs	No	806lm	101lm/W	3000 K	80
87%	15,000 hrs	No	806lm	101lm/W	6500 K	80
86%	15,000 hrs	No	1055lm	100lm/W	3000 K	80
86%	15,000 hrs	No	1055lm	100lm/W	6500 K	80
86%	15,000 hrs	No	1055lm	100lm/W	3000 K	80
86%	15,000 hrs	No	1055lm	100lm/W	6500 K	80
86%	15,000 hrs	No	1400lm	108lm/W	3000 K	80
86%	15,000 hrs	No	1400lm	108lm/W	6500 K	80
86%	15,000 hrs	No	1400lm	108lm/W	3000 K	80
86%	15,000 hrs	No	1400lm	108lm/W	6500 K	80

MegaBright LED Bulb

- High output LED lamps designed for applications that require a low cost retrofit solution
- Designed to replace mains voltage GLS, ML and CFL-i lamps
- Wide range of outputs and base caps available

Order code	Description	LED	Traditional
MBL1700LA67WWES	LEDBulb 14.5-120W E27 3000K 230V A67 AU	14.5W	120W
MBL1700LA67WWBC	LEDBulb 14.5-120W B22 3000K 230V A67 AU	14.5W	120W
MBL1800LA67CWES	LEDBulb 14.5-120W E27 6500K 230V A67 AU	14.5W	120W
MBL1800LA67CWBC	LEDBulb 14.5-120W B22 6500K 230V A67 AU	14.5W	120W
MBL2300LA80CWES	LEDBulb 19-160W E27 6500K 230V A80 AU	19W	160W
MBL2300LA80CWBC	LEDBulb 19-160W B22 6500K 230V A80 AU	19W	160W
MBL3000LA110CWE	LEDBulb 23-200W E27 6500K 230V A110 AU	23W	200W / 160W / 45W
MBL4000LA110CWE	LEDBulb 33W E27 6500K 230V A110 AU	33W	65W
MBL5000LA130CWE	LEDBulb 40W E27 6500K 230V A130 AU	40W	250W
MB5000LA130CWE4	LEDBulb 40W E40 6500K 230V A130 AU	40W	250W



Save up to	Lifetime	Dimmable	Lumen output	Efficacy	Colour temp.	CRI
88%	10,000 hrs	No	1700lm	117lm/W	3000 K	80
88%	10,000 hrs	No	1700lm	117lm/W	3000 K	80
88%	10,000 hrs	No	1800lm	124lm/W	6500 K	80
88%	10,000 hrs	No	1800lm	124lm/W	6500 K	80
88%	10,000 hrs	No	2300lm	121lm/W	6500 K	80
88%	10,000 hrs	No	2300lm	121lm/W	6500 K	80
89%	10,000 hrs	No	3000lm	130lm/W	6500 K	80
49%	10,000 hrs	No	4000lm	121lm/W	6500 K	80
84%	10,000 hrs	No	5000lm	125lm/W	6500 K	80
84%	10,000 hrs	No	5000lm	125lm/W	6500 K	80

LEDstick

- Compact design for slim luminaires
- Over 85% energy saving
- Up to 70% less glare than the Philips CFL-I Genie lamp

Order code	Description	LED	Traditional
LSTICK750LE27WW	LEDstick 7.5W E27 3000K 1BC/3 AU	7.5W	55W
LSTICK806LE27CW	LEDstick 7.5W E27 6500K 1BC/3 AU	7.5W	60W
LSTICK750LB22WW	LEDstick 7.5W B22 3000K 1BC/3 AU	7.5W	55W
LSTICK806LB22CW	LEDstick 7.5W B22 6500K 1BC/3 AU	7.5W	60W
LSTIC1055LE27WW	LEDstick 11W E27 3000K 1BC/3 AU	11W	75W
LSTIC1150LE27CW	LEDstick 11W E27 6500K 1BC/3 AU	11W	80W
LSTIC1055LB22WW	LEDstick 11W B22 3000K 1BC/3 AU	11W	75W
LSTIC1150LB22CW	LEDstick 11W B22 6500K 1BC/3 AU	11W	80W



Save up to	Lifetime	Dimmable	Lumen output	Efficacy	Colour temp.	CRI
86%	15,000 hrs	No	750lm	100lm/W	3000 K	80
88%	15,000 hrs	No	806lm	107lm/W	6500 K	80
86%	15,000 hrs	No	750lm	100lm/W	3000 K	80
88%	15,000 hrs	No	806lm	107lm/W	6500 K	80
85%	15,000 hrs	No	1055lm	96lm/W	3000 K	80
86%	15,000 hrs	No	1150lm	105lm/W	6500 K	80
85%	15,000 hrs	No	1055lm	96lm/W	3000 K	80
86%	15,000 hrs	No	1150lm	105lm/W	6500 K	80

Dimmable LED Bulb

- Ideal for general lighting applications where dimming is required
- Reduced energy and maintenance costs from increased efficacy & longer lamp life

Order code	Description	LED	Traditional
DLB806LA60WWES	LEDBulb 8.5-60W A60 E27 2700K FR D AU/BC	8.5W	60W
DLB806LA60WWBC	LEDBulb 8.5-60W B22 2700K A60 D AU/BC	8.5W	60W
MLED8.5WA60ESWW	MAS LEDbulb DT 8.5-60W E27 A60 CL	8.5W	60W
MLED8.5WA60BCWW	MAS LEDbulb DT 8.5-60W B22 A60 CL	8.5W	60W
MLED11WA60E27WW	MAS LEDBULB DT 11-75W A67 E27 827 FR	11W	75W
MLED11WA60B22WW	MAS LEDBULB DT 11-75W A67 B22 827 FR	11W	75W



Save up to	Lifetime	Dimmable	Lumen output	Efficacy	Colour temp.	CRI
86%	15,000 hrs	Yes	806lm	95lm/W	2700 K	80
86%	15,000 hrs	Yes	806lm	95lm/W	2700 K	80
86%	15,000 hrs	WarmGlow	806lm	95lm/W	2700-2200 K	80
86%	15,000 hrs	WarmGlow	806lm	95lm/W	2700-2200 K	80
85%	25,000 hrs	WarmGlow	1055lm	96lm/W	2700-2200 K	80
85%	25,000 hrs	WarmGlow	1055lm	96lm/W	2700-2200 K	80

SceneSwitch StepDim LED Bulb

- Create the atmosphere you want with the flick of a switch
- Scene Switch StepDim lamps give three different light levels without the need to rewire
- Warm White Light - 2700K@100% / 2500K@40% / 2200K@10%

Order code	Description	LED	Traditional
S806T80LA60ESWW	SceneSwitch A60 3S 8-60W E27 2700K 1BC/3	8W	60W
S806T80LA60BCWW	SceneSwitch A60 3S 8-60W B22 2700K 1BC/3	8W	60W
S470T50LB38ESWW	SceneSwitch B38 3S 5.5-35W E14 2700KBC/3	5.5W	35W
S385T40LGU1036D	LEDSSW 4.5-50W GU10 827 36D 1BC/3	4.5W	50W





Save up to	Lifetime	Dimmable	Lumen output	Efficacy	Colour temp.	CRI
87%	15,000 hrs	No	806 / 320 / 80lm	100lm/W	2700 / 2500 / 2200 K	80
87%	15,000 hrs	No	806 / 320 / 80lm	100lm/W	2700 / 2500 / 2200 K	80
84%	15,000 hrs	No	470 / 190 / 50lm	85lm/W	2700 / 2500 / 2200 K	80
91%	15,000 hrs	No	385 / 140 / 40lm	86lm/W	2700 / 2500 / 2200 K	80

SceneSwitch Colour Change LED Bulb

- Create the atmosphere you want with the flick of a switch
- Scene Switch lamps change the colour temperature of the lamp from Cool Daylight to Warm without the need to change lamps
- Ideal to change the mood for different tasks in multi use spaces such as home office, kids study space, kitchens and more

Order code	Description	LED	Traditional
SS806LA60E27WCW	LEDSSW A60 9.5-60W E27 3000K/6500K_AU	9.5W	60W
SS806LA60B22WCW	LEDSSW A60 9.5-60W B22 3000K/6500K_AU	9.5W	60W





Save up to	Lifetime	Dimmable	Lumen output	Efficacy	Colour temp.	CRI
84%	15,000 hrs	No	806lm	85lm/W	6500-3000 K	80
84%	15,000 hrs	No	806lm	85lm/W	6500-3000 K	80

Classic LED Filament Lamps

- The Classic look of yesteryear with all the benefits of the latest LED technology
- Wide range of lamp shapes and base caps available for your decorative lighting needs
- Dimmable and non dimmable models available

Order code	Description	LED	Traditional
FLC250LBA35ESWW	LEDClassic 2-25W BA35 E14 WW CL ND AU	2W	25W
FLC250LP45E14WW	LEDClassic 2-25W P45 E14 WW CL ND 1BC AU	2W	25W
FLC800LA60B22WW	LEDClassic 6-60W A60 B22 WW CL ND 1CT AU	6W	60W
FLC800LA60E27WW	LEDClassic 6-60W A60 E27 WW CL ND 1CT AU	6W	60W
FC806LST64E27WW	LEDClassic 7-50W ST64 E27 2000K GOLD AU	7W	50W
FC806LST64B22WW	LEDClia 7-50W ST64 B22 2000K GOLD D AU	7W	50W
FC806LG120E27WW	LEDClassic 7-50W G120 E27 2000K GOLD AU	7W	50W
FC806LG120B22WW	LEDClia 7-50W G120 B22 2000K GOLD D AU	7W	50W



Save up to	Lifetime	Dimmable	Lumen output	Efficacy	Colour temp.	CRI
92%	15,000 hrs	No	250lm	125lm/W	2700 K	80
92%	15,000 hrs	No	250lm	125lm/W	2700 K	80
90%	15,000 hrs	No	800lm	133lm/W	2700 K	80
90%	15,000 hrs	No	800lm	133lm/W	2700 K	80
86%	25,000 hrs	Yes	806lm	115lm/W	2000 K	80
86%	25,000 hrs	Yes	806lm	115lm/W	2000 K	80
86%	25,000 hrs	Yes	806lm	115lm/W	2000 K	80
86%	25,000 hrs	Yes	806lm	115lm/W	2000 K	80

LED Candle & Lustre

- Update your decorative lighting needs with retro fit LED candle and lustres
- Clear and frosted options
- Wide range of outputs and base caps available

Order code	Description	LED	Traditional
Candle			
LC25WB35E14WWND	LED 4-25W E14 2700K 230V B35 CL ND_AU	4W	25W
LC25WB35B22WWND	LED 4-25W B22 2700K 230V B35 FR ND_AU	4W	25W
LC35WB35E14WWND	LED 5.5-35W E14 2700K 230V B35 CL ND_AU	5.5W	35W
LC35WB35B22WWND	LED 5.5-35W B22 2700K 230V B35 FR ND_AU	5.5W	35W
Lustre			
LL4WP45E14WWFR	LED 4-25W E14 2700K 220-240V 50Hz/60Hz P45 CL ND_AP	4W	25W
LB3WP45E14CW	LEDBulb 3-25W E14 6500K 230V P45_AU	3W	25W
LEDP454WESWW	LEDBulb 4-25W E27 3000K 230V P45(AU)	4W	25W
LEDP454WESCDL	LEDBulb 4-25W E27 6500K 230V P45(AU)	4W	25W
LL4WP45B22WWFR	LED 4-25W B22 2700K 230V P45 FR ND_AU	4W	25W
LL5.5P45E14WWND	LED 5.5-40W E14 2700K 220-240V 50Hz/60Hz P45 CL ND_AP	5.5W	40W
LL600LP50E14WW	LEDBulb 6.5-40W E14 3000K 220V P50_AU	6.5W	40W
LL600LP50E14CW	LEDBulb 6.5-40W E14 6500K 220V P50_AU	6.5W	40W
LL470LP45B22WWF	LED 5.5-35W B22 2700K 230V P45 FR ND_AU	5.5W	35W
LL470LP45B22WWF	LED 5.5-40W B22 2700K 230V P45 FR ND_AU	5.5W	40W



Save up to	Lifetime	Dimmable	Lumen output	Efficacy	Colour temp.	CRI
84%	15,000 hrs	No	250lm	63lm/W	2700 K	80
84%	15,000 hrs	No	250lm	63lm/W	2700 K	80
84%	15,000 hrs	No	470lm	85lm/W	2700 K	80
84%	15,000 hrs	No	470lm	85lm/W	2700 K	80
84%	15,000 hrs	No	250lm	63lm/W	2700 K	80
88%	15,000 hrs	No	250lm	83lm/W	6500 K	80
84%	15,000 hrs	No	250lm	63lm/W	3000 K	80
84%	15,000 hrs	No	250lm	63lm/W	6500 K	80
84%	15,000 hrs	No	250lm	63lm/W	2700 K	80
86%	15,000 hrs	No	470lm	85lm/W	2700 K	80
84%	15,000 hrs	No	600lm	92lm/W	3000 K	80
84%	15,000 hrs	No	600lm	92lm/W	6500 K	80
84%	15,000 hrs	No	470lm	85lm/W	2700 K	80
86%	15,000 hrs	No	470lm	85lm/W	2700 K	80

LED Globe

- Available in G93 and G120 sizes with different outputs
- Warm white light (2700K) is perfect for Pendant & Floor lamps
- Non Dimmable

Order code	Description	LED	Traditional
G93806LE27WW	LEDGlobe9.5-60W G93 E27 WW 230V AU	9.5W	60W
G93806LB22WW	LEDGlobe9.5-60W G93 B22 WW 230V AU	9.5W	60W
G1201000LE27WW	LEDGlobe11.5-75W G120 E27 WW 230V AU	11.5W	75W
G1201000LB22WW	LEDGlobe11.5-75W G120 B22 WW 230V AU	11.5W	75W



Save up to	Lifetime	Dimmable	Lumen output	Efficacy	Colour temp.	CRI
84%	15,000 hrs	No	806lm	85lm/W	2700 K	80
84%	15,000 hrs	No	806lm	85lm/W	2700 K	80
85%	15,000 hrs	No	1055lm	92lm/W	2700 K	80
85%	15,000 hrs	No	1055lm	92lm/W	2700 K	80

LED Appliance

- Reduced energy and maintenance costs from increased efficacy & longer lamp life
- Not for use in microwave or conventional ovens

Order code	Description	LED	Traditional
LAL136LT25E14WW	LED 15W E14 WW 230V T25 ND/4	1.7W	15W

LED Capsules

- Both mains voltage and low voltage options available
- Reduced energy and maintenance costs from increased efficacy & longer lamp life

Order code	Description	LED	Traditional
Mains Voltage			
LEDCAP2WG9WW	LED Capsule G9 2.5-25W 827 1BC/10	2.5W	25W
Low Voltage			
LEDCAP2WG4WW	LED Capsule G4 2-20W 830 1BC/10	2W	20W



Save up to	Lifetime	Dimmable	Lumen output	Efficacy	Colour temp.	CRI
89%	15,000 hrs	No	136lm	80lm/W	3000 K	80



Save up to	Lifetime	Dimmable	Lumen output	Efficacy	Colour temp.	CRI
90%	15,000 hrs	No	204lm	82lm/W	2700 K	80
90%	15,000 hrs	No	195lm	98lm/W	3000 K	80

LED Reflector

- Multiple models available for replacing conventional reflector lamps with R80, R63 & R50 shapes available
- Dimming and Non Dimming models

Order code	Description	LED	Traditional
LEDR503.5WE14WW	LED R50 WW FL E14 Dim AU 1CT	3.5W	40W
LEDR635WESWW	LED R63 WW FL E27 Dim AU 1CT	5W	60W
LEDR809WESWW	LED R80 9W WH FL NZ 1PF	9W	75W

LED PAR

- Easy retro fit for wide range of general and spot lighting applications
- Reduced energy and maintenance costs from increased efficacy & longer lamp life
- Suitable for outdoor use (IP65)

Order code	Description	LED	Traditional
LPL900L25DPAR38	LEDClassic 11-80WPAR38 827 25D 1BC/3 SRT	11W	80W



Save up to	Lifetime	Dimmable	Lumen output	Efficacy	Colour temp.	CRI
91%	15,000 hrs	Yes	280lm	80lm/W	2700 K	80
92%	15,000 hrs	Yes	400lm	80lm/W	2700 K	80
88%	15,000 hrs	No	800lm	89lm/W	3000 K	80



Save up to	Lifetime	Dimmable	Lumen output	Efficacy	Colour temp.	CRI
86%	15,000 hrs	No	900lm	82lm/W	2700 K	80

ExpertColor Spots

- When only the best will do. ExpertColor sets a new standard in LED light quality for spot and downlight applications
- Create a warm and comfortable ambience for hospitality venues, homes and restaurants with deep dimming down to 5%
- GU10 and MR16 lamps with excellent colour rendering (CRI97), creates a beautiful lighting experience

Order code	Description	LED	Traditional
ExpertColor MR16			
MEC450LMR1610D	MAS LED MR16 ExpertColor 7.2-50W 927 10D	7.2W	50W
MEC450LMR1624D	MAS LED MR16 ExpertColor 7.2-50W 927 24D	7.2W	50W
MEC450LMR1636D	MAS LED MR16 ExpertColor 7.2-50W 927 36D	7.2W	50W
MEC450LMR1660D	MAS LED MR16 ExpertColor 7.2-50W 927 60D	7.2W	50W
MEC480LMR1610D	MAS LED MR16 ExpertColor 7.2-50W 930 10D	7.2W	50W
MEC480LMR1624D	MAS LED MR16 ExpertColor 7.2-50W 930 24D	7.2W	50W
MEC480LMR1636D	MAS LED MR16 ExpertColor 7.2-50W 930 36D	7.2W	50W
MEC480LMR1660D	MAS LED MR16 ExpertColor 7.2-50W 930 60D	7.2W	50W
MEC510LMR1610D	MAS LED MR16 ExpertColor 7.2-50W 940 10D	7.2W	50W
MEC510LMR1624D	MAS LED MR16 ExpertColor 7.2-50W 940 24D	7.2W	50W
MEC510LMR1636D	MAS LED MR16 ExpertColor 7.2-50W 940 36D	7.2W	50W
MEC510LMR1660D	MAS LED MR16 ExpertColor 7.2-50W 940 60D	7.2W	50W
ExpertColor GU10			
MEC385L24D927GU	MAS LED ExpertColor 5.5-50W GU10 927 24D	5.5W	50W
MEC405L36D927GU	MAS LED ExpertColor 5.5-50W GU10 927 36D	5.5W	50W
MEC385L24D930GU	MAS LED ExpertColor 5.5-50W GU10 930 24D	5.5W	50W
MEC405L36D930GU	MAS LED ExpertColor 5.5-50W GU10 930 36D	5.5W	50W



Save up to	Lifetime	Dimmable	Lumen output	Efficacy	Colour temp.	CRI
86%	40,000 hrs	Yes	450lm	63lm/W	2700 K	97
86%	40,000 hrs	Yes	450lm	63lm/W	2700 K	97
86%	40,000 hrs	Yes	450lm	63lm/W	2700 K	97
86%	40,000 hrs	Yes	450lm	63lm/W	2700 K	97
86%	40,000 hrs	Yes	480lm	67lm/W	3000 K	97
86%	40,000 hrs	Yes	480lm	67lm/W	3000 K	97
86%	40,000 hrs	Yes	480lm	67lm/W	3000 K	97
86%	40,000 hrs	Yes	480lm	67lm/W	3000 K	97
86%	40,000 hrs	Yes	510lm	71lm/W	4000 K	97
86%	40,000 hrs	Yes	510lm	71lm/W	4000 K	97
86%	40,000 hrs	Yes	510lm	71lm/W	4000 K	97
86%	40,000 hrs	Yes	510lm	71lm/W	4000 K	97
89%	40,000 hrs	Yes	385lm	70lm/W	2700 K	97
89%	40,000 hrs	Yes	405lm	74lm/W	2700 K	97
89%	40,000 hrs	Yes	385lm	70lm/W	3000 K	97
89%	40,000 hrs	Yes	405lm	74lm/W	3000 K	97

Master LED Spots

- Wide range of models for commercial applications including MR16, GU10 and AR111
- Dimmable and non dimmable models available
- Wide range of beam angles and colour temperatures available
- Master models have long lamp life and are ideal for commercial applications where reliability and reduced maintenance are required

Order code	Description	LED	Traditional
Master Non Dim MR16			
MLED4W2700K24D	MASTER LED 4-35W 2700K MR16 24D	4W	35W
MLED4W3000K24D	MASTER LED 4-35W 3000K MR16 24D	4W	35W
Master Dim MR16			
MLED7W92724D	MASTER LED 7W 927 MR16 24D Dim AU	7W	50W
MLED7W93024D	MASTER LED 7W 930 MR16 24D Dim AU	7W	50W
MLED7W94024D	MASTER LED 7W 940 MR16 24D Dim AU	7W	50W
MLED7W92736D	MASTER LED 7W 927 MR16 36D Dim AU	7W	50W
MLED7W93036D	MASTER LED 7W 930 MR16 36D Dim AU	7W	50W
MLED7W94036D	MASTER LED 7W 940 MR16 36D Dim AU	7W	50W
MLED7W92760D	MASTER LED 7W 927 MR16 60D Dim AU	7W	50W
MLED7W93060D	MASTER LED 7W 930 MR16 60D Dim AU	7W	50W
MLED7W94060D	MASTER LED 7W 940 MR16 60D Dim AU	7W	50W
AR111 Dim			
15WAR111WW24D92	MAS LEDspotLV D 15-75W 927 AR111 24D	15W	75W
15WAR111WW40D92	MAS LEDspotLV D 15-75W 927 AR111 40D	15W	75W
20WAR111WW12D83	MAS LEDspotLV D 20-100W 830 AR111 12D	20W	100W
20WAR111NW12D84	MAS LEDspotLV D 20-100W 840 AR111 12D	20W	100W
20WAR111WW24D83	MAS LEDspotLV D 20-100W 830 AR111 24D	20W	100W
20WAR111NW24D84	MAS LEDspotLV D 20-100W 840 AR111 24D	20W	100W
20WAR111WW40D83	MAS LEDspotLV D 20-100W 830 AR111 40D	20W	100W
20WAR111NW40D84	MAS LEDspotLV D 20-100W 840 AR111 40D	20W	100W
Master LED GU10			
M395L36D927GU10	Master LED 5-50W GU10 927 36D Dim	5.5W	50W
M405L36D930GU10	Master LED 5-50W GU10 930 36D Dim	5.5W	50W
M420L36D940GU10	Master LED 5-50W GU10 940 36D Dim	5.5W	50W



Save up to	Lifetime	Dimmable	Lumen output	Efficacy	Colour temp.	CRI
89%	25,000 hrs	No	240lm	60lm/W	2700 K	80
89%	25,000 hrs	No	240lm	60lm/W	3000 K	80
86%	40,000 hrs	Yes	440lm	63lm/W	2700 K	
86%	40,000 hrs	Yes	440lm	63lm/W	3000 K	90
86%	40,000 hrs	Yes	440lm	63lm/W	4000 K	90
86%	40,000 hrs	Yes	440lm	63lm/W	2700 K	90
86%	40,000 hrs	Yes	440lm	63lm/W	3000 K	90
86%	40,000 hrs	Yes	440lm	63lm/W	4000 K	90
86%	40,000 hrs	Yes	460lm	66lm/W	2700 K	90
86%	40,000 hrs	Yes	460lm	66lm/W	3000 K	90
86%	40,000 hrs	Yes	460lm	66lm/W	4000 K	90
80%	40,000 hrs	Yes	830lm	55lm/W	2700 K	90
80%	40,000 hrs	Yes	830lm	55lm/W	2700 K	90
80%	25,000 hrs	Yes	1350lm	68lm/W	3000 K	80
80%	25,000 hrs	Yes	1400lm	70lm/W	4000 K	80
80%	25,000 hrs	Yes	1350lm	68lm/W	3000 K	80
80%	25,000 hrs	Yes	1400lm	70lm/W	4000 K	80
80%	25,000 hrs	Yes	1350lm	68lm/W	3000 K	80
80%	25,000 hrs	Yes	1400lm	70lm/W	4000 K	80
89%	25,000 hrs	Yes	395lm	72lm/W	2700 K	90
89%	25,000 hrs	Yes	405lm	74lm/W	3000 K	90
89%	25,000 hrs	Yes	420lm	76lm/W	4000 K	90

Classic LED Spots

- Classic glass look with all the benefits of LED
- Cost effective residential MR16 and GU10 lamps for spotlighting and down lighting
- Dimmable and non dimmable models available

Order code	Description	LED	Traditional
Classic Non Dim MR16			
LCND390L60DMR16	LEDClassic 5-50W MR16 830 60D 1BC/10	5W	50W
LCND410L60DMR16	LEDClassic 5-50W MR16 840 60D 1BC/10	5W	50W
Classic Dim MR16			
LCD650L60DMR16	LED 8-50W MR16 60D 830 DIM 1BC/10	8W	50W
LCD670L60DMR16	LED 8-50W MR16 60D 840 DIM 1BC/10	8W	50W
Classic Non Dim GU10			
LC405LGU10WW830	LEDClassic 4.5-50W GU10 830 60D 1BC/10	4.5W	50W
LC405LGU10WW840	LEDClassic 4.5-50W GU10 840 60D 1BC/10	4.5W	50W
Classic Dim GU10			
LC5WGU10DB3060D	LEDCLASSIC 5.5-50W GU10 830 60D D 1BC/10	5.5W	50W



Save up to	Lifetime	Dimmable	Lumen output	Efficacy	Colour temp.	CRI
90%	15,000 hrs	No	390lm	78lm/W	3000 K	80
90%	15,000 hrs	No	410lm	82lm/W	4000 K	80
84%	15,000 hrs	Yes	650lm	81lm/W	3000 K	80
84%	15,000 hrs	Yes	670lm	84lm/W	4000 K	80
91%	15,000 hrs	No	405lm	90lm/W	3000 K	80
91%	15,000 hrs	No	405lm	90lm/W	4000 K	80
89%	15,000 hrs	Yes	365lm	66lm/W	3000 K	80

DimSure Dimming Accessory

- When dimming low voltage LED lamps some issues can arise due to the mix of different lamps, transformers and dimmers. The DimSure accessory helps to solve these issues
- Improved dimmer stability and deeper dimming
- Easy to install between the dimmer and the first lamp in the circuit

Order code	Description	LED	Traditional
DIMSUREACCESSOR	DimSure dimmer accessory	N/A	N/A

LED Tubes

- Affordable LED solution suitable for replacing T8 fluorescent lamps
- The product provides a natural lighting effect for use in general lighting applications
- Suitable for a wide range of applications including General lighting and car parks, signage, warehouses and cool rooms

Order code	Description	LED	Traditional
TLED600840	CorePro LEDtube 600mm 8W 840 C G	8W	18W
TLED600865	CorePro LEDtube 600mm 8W 865 C G	8W	18W
TLED1200840	CorePro LEDtube 1200mm 20W 840 C G	20W	36W
TLED1200865	CorePro LEDtube 1200mm 20W 865 C G	20W	36W
TLED1500840	CorePro LEDtube 1500mm 25W 840 C	25W	58W
TLED1500865	CorePro LEDtube 1500mm 25W 865 C	25W	58W



Save up to	Lifetime	Lumen output	Efficacy	Colour temp.	CRI
N/A	N/A	N/A	N/A	N/A	N/A



Save up to	Lifetime	Dimmable	Lumen output	Efficacy	Colour temp.	CRI
56%	30,000 hrs	No	800lm	100lm/W	4000 K	80
56%	30,000 hrs	No	800lm	100lm/W	6500 K	80
44%	30,000 hrs	No	2100lm	105lm/W	4000 K	80
44%	30,000 hrs	No	2100lm	105lm/W	6500 K	80
57%	30,000 hrs	No	3000lm	120lm/W	4000 K	80
57%	30,000 hrs	No	3000lm	120lm/W	6500 K	80

LED PL-C

- Ideal retro fit lamps for commercial down lighting applications
- Reduced energy and maintenance costs from increased efficacy & longer lamp life
- PL-C 2 Pin lamps to replace 13W, 18W & 26W fluorescent lamps
- Rotatable end cap
- Compatible with all Electro Magnetic ballasts

Order code	Description	LED	Traditional
2Pin			
LEDPL4.5W8302P	LED PLC 4.5W 830 2P G24d-1	4.5W	13W
LEDPL4.5W8402P	LED PLC 4.5W 840 2P G24d-1	4.5W	13W
LEDPL6.5W8302P	LED PLC 6.5W 830 2P G24d-2	6.5W	18W
LEDPL6.5W8402P	LED PLC 6.5W 840 2P G24d-2	6.5W	18W
LEDPL8.5W8302P	LED PLC 8.5W 830 2P G24d-3	8.5W	26W
LEDPL8.5W8402P	LED PLC 8.5W 840 2P G24d-3	8.5W	26W



Save up to	Lifetime	Dimmable	Lumen output	Efficacy	Colour temp.	CRI
65%	30,000 hrs	No	475lm	106lm/W	3000 K	80
65%	30,000 hrs	No	500lm	111lm/W	4000 K	80
64%	30,000 hrs	No	600lm	92lm/W	3000 K	80
64%	30,000 hrs	No	650lm	100lm/W	4000 K	80
67%	30,000 hrs	No	900lm	106lm/W	3000 K	80
67%	30,000 hrs	No	950lm	112lm/W	4000 K	80



PHILIPS

hue personal
wireless
lighting

Inspire your customers with a personal wireless lighting system

Turn your customers on to Philips Hue. It's the personal wireless system that transforms everyday lighting into an extraordinary experience. Your customers can use Hue to wake them up. Welcome them home. Get energised. Improve their mood or enhance their entertainment experience. It can even keep them informed about the weather or incoming calls.



Philips Hue Lamps, choose from:

- Hue White & Colour Ambiance Lamps - 16 million colours plus all shades of white from warm to cold colour temperatures
- Hue White Lamps - High quality dimmable white light



Philips Hue LightStrips and 1m extension

Easy to shape, bend and cut to size



Philips Hue Dimmer Switch

Dim your Philips Hue lights without needing your smart device. Place it anywhere or use as a remote control



Philips Hue Tap Switch

Recall favourite Philips Hue scenes - no batteries required



Philips Hue Bridge

Add up to 50 Hue lights and extend with accessories



Philips Hue Downlight

Create your ambience, from warm white to cool daylight



Philips Lighting Australia
65 Epping Road,
North Ryde 2113, Australia
Tel: 1300 304 404
www.philips.com.au/lighting
Email: clubblueau@philips.com

©2017 Koninklijke Philips N.V.

All rights reserved. Reproduction in whole or in part is prohibited without prior written consent of the copyright owner. The information presented in this document does not form part of any quotation or contract, is believed to be accurate and reliable and may be changed without notice. No liability will be accepted by the publisher for any consequence of its use. Publication thereof does not convey nor imply any license under patent – or other industrial or intellectual property rights.