



# Philips Lighting Catalogue

**Voorschakelapparatuur en  
Lighting Controls**

Fluorescentie

**PHILIPS**

# HF-REGULATOR Intelligent Touch & DALI



- Compacte dimbare elektronische Touch & DALI voorschakelapparatuur voor TL5 fluorescentielampen
- Voorzien van zowel een digitale DALI interface voor de onderlinge communicatie en het programmeren van de voorschakelapparatuur als het Touch & Dim protocol
- DALI en Touch & Dim kunnen niet samen gebruikt worden
- Dimbaar tot 1% van de initiële lichtstroom
- Geen flikkering van de lamp
- Constante lichtstroom
- 10% uitval bij 50.000 uur bij een Tcase van 75 °C
- Warme start
- Opstarttijd <0,5 s
- Geschikt voor gebruik in combinatie met lichtregelapparatuur
- Energy Efficiency Index (EEI) A1 BAT

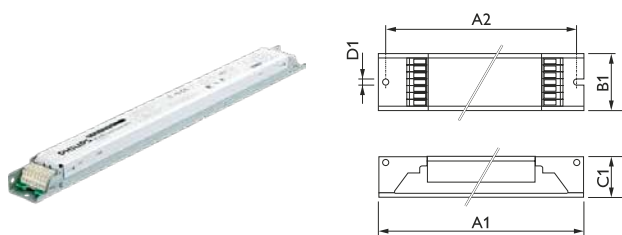

HF-Ri TD 2 28/35/49/54

Afmetingen in mm.

Afm. no.	A1 Nom	A2 Nom	B1 Nom	C1 Nom	D1 Nom
1	360	350	39	22	4.2
2	360	350	30	22	4.1

## Bestelgegevens

EOC	Type aanduiding	Typenummer	MOQ	VRG code	Richtprijs	Afm. no.
24167600	HF-Ri TD 1 26-42 PL-T/C E+	HFRITD12642PLTC	12	BE	84,65	
71864200	HF-Ri TD 155 TL5C E+ 195-240V 50/60Hz	HFRITD155TL5C	12	BE	96,15	
71862800	HF-Ri TD 160 TL5C E+ 195-240V 50/60Hz	HFRITD160TL5C	12	BE	96,15	
24169000	HF-Ri TD 2 26-42 PL-T/C E+	HFRITD22642PLTC	12	BE	93,10	
91067730	HF-Ri TD 280 TL5/PL-L E+ 220-240V	HFRITD280TL5PLL	12	BE	91,65	

### 1 lamp

EOC	Type aanduiding	Typenummer	MOQ	VRG code	Richtprijs	Afm. no.
69689600	HF-Ri TD 1 14/21/24/39 E+	HFRITD11439TLG2	12	BE	69,70	2
66205100	HF-Ri TD 1 28/35/49/54 TL5 E+ 195-240V	HFRITD12854T5G2	12	BE	69,70	2
66207500	HF-Ri TD 1 35/49/80 TL5 E+ 195-240V	HFRITD13580T5G2	12	BE	77,70	2

### 2 lampen

EOC	Type aanduiding	Typenummer	MOQ	VRG code	Richtprijs	Afm. no.
69691900	HF-Ri TD 2 14/21/24/39 E+	HFRITD21439TLG2	12	BE	77,70	2
66209900	HF-Ri TD 2 28/35/49/54 TL5 E+ 195-240V	HFRITD22854T5G2	12	BE	77,70	2

### 3 en 4 lampen

EOC	Type aanduiding	Typenummer	MOQ	VRG code	Richtprijs	Afm. no.
15678900	HF-Ri TD 4 14/24 TL5 E+ 195-240V	HFRITD4TL5E+	10	BE	95,75	1

# HF-REGULATOR II Touch & DALI PL-L



- Compacte dimbare elektronische Touch & DALI voorschakelapparatuur voor compacte PL-L fluorescentielampen
- Voorzien van zowel een digitale DALI interface voor de voorschakelapparatuur als het Touch & Dim protocol
- DALI en Touch & Dim kunnen niet samen gebruikt worden
- Dimbaar tot 1% van de initiële lichtstroom
- Geen flikkering van de lamp
- Constante lichtstroom
- 10% uitval bij 50.000 uur bij een Tcase van 75 °C
- Warme start
- Opstarttijd <0,5 s
- Geschikt voor gebruik in combinatie met lichtregelapparatuur
- Energy Efficiency Index (EEI) A1



asimpleswitch.com

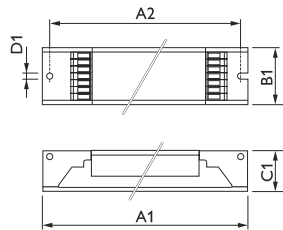

HF-R II Touch & DALI

Afmetingen in mm.

Afm. no.	A1 Nom	A2 Nom	B1 Nom	C1 Nom	D1 Nom
1	425	415	30	22	5
2	360	350	30	22	5
3	359	350	30	22	5

## Bestelgegevens

2 lampen EOC	Type aanduiding	Typenummer	MOQ	VRG code	Richtprijs	Afm. no.
91067730	HF-Ri TD 280 TL5/PL-L E+ 220-240V	HFRTD280TL5PLL	12	BE	91,65	2

# HF-REGULATOR II TL5



- Compacte dimbare elektronische 1-10 V voorschakelapparatuur voor TL5 fluorescentielampen
- Dimbaar tot 1% van de initiële lichtstroom
- Geen flikkering van de lamp
- Constante lichtstroom
- 10% uitval bij 50.000 uur bij een Tcase van 75 °C
- Warme start
- Opstarttijd < 0,5 s
- Geschikt voor gebruik in combinatie met lichtregelapparatuur
- Energy Efficiency Index (EEI) A1

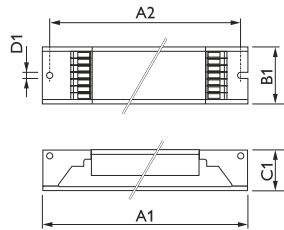

HF-R II

Afmetingen in mm.

Afm. no.	A1 Nom	A2 Nom	B1 Nom	C1 Nom	D1 Nom
1	360	350	3309	22	5
2	359	350	30	22	5
3	425	415	30	22	5
4	359	350	39	22	5

## Bestelgegevens

1 lamp		Typenummer	MOQ VRG	Richtprijs	Afm.
EOC	Type aanduiding		code		no.
91180330	HF-R 114-35 TL5 EII 220-240V 50/60Hz	HFR11435TL5EII	12 BE	72,35	1
91468230	HF-R 139 TL5 EII 220-240V 50/60Hz	HFR139TL5EII	12 BE	72,35	2
90998530	HF-R 149 TL5 EII 220-240V 50/60Hz	HFR149TL5EII	12 BE	72,35	1
91005930	HF-R 154 TL5 EII 220-240V 50/60Hz	HFR154TL5EII	12 BE	72,35	1
91011030	HF-R 180 TL5/PL-L EII 220-240V 50/60Hz	HFR180TL5PLLEII	12 BE	85,20	1

2 lampen		Typenummer	MOQ VRG	Richtprijs	Afm.
EOC	Type aanduiding		code		no.
91178030	HF-R 2 14-35 TL5 EII 220-240V 50/60Hz	HFR21435TL5EII	12 BE	80,60	1
91472930	HF-R 224 TL5/PL-L EII 220-240V 50/60Hz	HFR224TL5PLLEII	12 BE	80,60	2
91474330	HF-R 239 TL5 EII 220-240V 50/60Hz	HFR239TL5EII	12 BE	80,60	2
91003530	HF-R 249 TL5 EII 220-240V 50/60Hz	HFR249TL5EII	12 BE	80,60	1
91008030	HF-R 254 TL5 EII 220-240V 50/60Hz	HFR254TL5EII	12 BE	80,60	1
91065330	HF-R 280 TL5/PL-L EII 220-240V 50/60Hz	HFR280TL5PLLEII	12 BE	94,50	3

3 lampen		Typenummer	MOQ VRG	Richtprijs	Afm.
EOC	Type aanduiding		code		no.
91368530	HF-R 314 TL5 EII 220-240V 50/60Hz	HFR314TL5EII	10 BE	94,50	4

4 lampen		Typenummer	MOQ VRG	Richtprijs	Afm.
EOC	Type aanduiding		code		no.
91364730	HF-R 414 TL5 EII 220-240V 50/60Hz	HFR414TL5EII	10 BE	94,50	4
91374630	HF-R 424 TL5/PL-L EII 220-240V 50/60Hz	HFR424TL5PLLEII	10 BE	94,50	4

# HF-REGULATOR II TL-D



- Compacte dimbare elektronische 1-10 V voorschakelapparatuur voor TL-D fluorescentielampen
- Dimbaar tot 1% van de initiële lichtstroom
- Geen flikkering van de lamp
- Constante lichtstroom
- 10% uitval bij 50.000 uur bij een Tcase van 75 °C
- Warme start
- Opstarttijd < 0,5 s
- Geschikt voor gebruik in combinatie met lichtregelapparatuur
- Energy Efficiency Index (EEI) A1

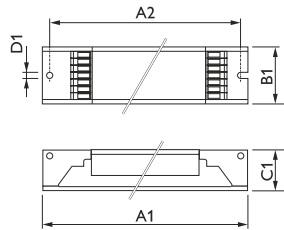

HF-R II

Afmetingen in mm.

Afm. no.	A1 Nom	A2 Nom	B1 Nom	C1 Nom	D1 Nom
1	360	350	30	22	5
2	359	350	39	22	5

## Bestelgegevens

1 lamp							
EOC	Type aanduiding	Typenummer	MOQ	VRG code	Richtprijs	Afm. no.	
91190230	HF-R 118 TL-D EII 220-240V 50/60Hz	HFR118TLDEII	12	BE	65,75	1	
91013430	HF-R 136 TL-D EII 220-240V 50/60Hz	HFR136TLDEII	12	BE	65,75	1	
91017230	HF-R 158 TL-D EII 220-240V 50/60Hz	HFR158TLDEII	12	BE	65,75	1	

2 lampen							
EOC	Type aanduiding	Typenummer	MOQ	VRG code	Richtprijs	Afm. no.	
91192630	HF-R 218 TL-D EII 220-240V 50/60Hz	HFR218TLDEII	12	BE	71,65	1	
91015830	HF-R 236 TL-D EII 220-240V 50/60Hz	HFR236TLDEII	12	BE	71,65	1	
91019630	HF-R 258 TL-D EII 220-240V 50/60Hz	HFR258TLDEII	12	BE	71,65	1	

3 lampen							
EOC	Type aanduiding	Typenummer	MOQ	VRG code	Richtprijs	Afm. no.	
91376030	HF-R 318 TL-D EII 220-240V 50/60Hz	HFR318TLDEII	10	BE	85,95	2	

4 lampen							
EOC	Type aanduiding	Typenummer	MOQ	VRG code	Richtprijs	Afm. no.	
91366130	HF-R 418 TL-D EII 220-240V 50/60Hz	HFR418TLDEII	10	BE	85,95	2	



# HF-REGULATOR II PL-T/C



- Compacte dimbare elektronische 1-10 V voorschakelapparatuur voor PL-T/C fluorescentielampen
- Dimbaar tot 1% van de initiële lichtstroom (3% voor 18 W)
- Geen flikkering van de lamp
- Constante lichtstroom
- 10% uitval bij 50.000 uur bij een Tcase van 75 °C (65 °C voor 18 W)
- Warme start
- Opstarttijd < 0,5 s (2 s voor 18 W)
- Geschikt voor gebruik in combinatie met lichtregelapparatuur
- Ook leverbaar in "Touch & DALI" uitvoeringen
- Energy Efficiency Index (EEI) A1



HF-R

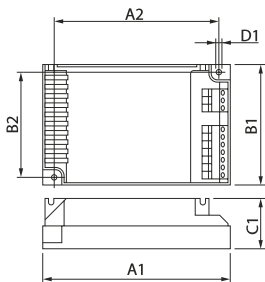

Afmetingen in mm.

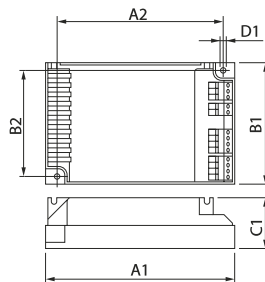

Afmetingen in mm.

Afm. no.	A1 Nom	A2 Nom	B1 Nom	B2 Nom	C1 Nom	D1 Nom	Afm. no.	A1 Nom	A2 Nom	B1 Nom	B2 Nom	C1 Nom	D1 Nom
1	123	111	79	67	33	5	2	123	111	79	67	33	5

## Bestelgegevens

EOC	Type aanduiding	Typenummer	MOQ	VRG code	Richtprijs	Afm. no.
17698500	HF-R 218 PL-T/C EII 220-240V 50/60Hz	HFR218PLTCEII	12	BE	83,85	
<b>1 lamp</b>						
EOC	Type aanduiding	Typenummer	MOQ	VRG code	Richtprijs	Afm. no.
80971800	HF-R 1 26-42 PL-T/C EII 220-240V 50/60Hz	HFR12642PLTCEII	12	BE	76,20	1
<b>2 lampen</b>						
EOC	Type aanduiding	Typenummer	MOQ	VRG code	Richtprijs	Afm. no.
80972500	HF-R 2 26-42 PL-T/C EII 220-240V 50/60Hz	HFR22642PLTCEII	12	BE	83,85	2

# HF-REGULATOR II PL-L



- Compacte dimbare elektronische 1-10 V voorschakelapparatuur voor compacte PL-L fluorescentielampen
- Dimbaar tot 1% van de initiële lichtstroom
- Geen flikkering van de lamp
- Constante lichtstroom
- 10% uitval bij 50.000 uur bij een Tcase van 75 °C
- Opstarttijd < 0,5 s
- Geschikt voor gebruik in combinatie met lichtregelapparatuur
- Energy Efficiency Index (EEI) A1

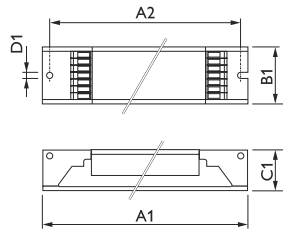

HF-R II

Afmetingen in mm.

Afm. no.	A1 Nom	A2 Nom	B1 Nom	C1 Nom	D1 Nom
1	360	350	30	22	5
2	425	415	30	22	5
3	359	350	39	22	5
4	359	350	30	22	5

## Bestelgegevens

1 lamp							
EOC	Type aanduiding	Typenummer	MOQ	VRG code	Richtprijs	Afm. no.	
91011030	HF-R 180 TL5/PL-L EII 220-240V 50/60Hz	HFR180TL5PLLEII	12	BE	85,20	1	
2 lampen							
EOC	Type aanduiding	Typenummer	MOQ	VRG code	Richtprijs	Afm. no.	
91472930	HF-R 224 TL5/PL-L EII 220-240V 50/60Hz	HFR224TL5PLLEII	12	BE	80,60	4	
91065330	HF-R 280 TL5/PL-L EII 220-240V 50/60Hz	HFR280TL5PLLEII	12	BE	94,50	2	
4 lampen							
EOC	Type aanduiding	Typenummer	MOQ	VRG code	Richtprijs	Afm. no.	
91374630	HF-R 424 TL5/PL-L EII 220-240V 50/60Hz	HFR424TL5PLLEII	10	BE	94,50	3	

# HF-PERFORMER II Xtreme TL5/TL-D



- Compacte elektronische voorschakelapparatuur voor lange levensduur TL5 en TL-D fluorescentielampen (Xtra en Xtreme)
- Geen flikkering van de lamp
- Constante lichtstroom
- 10% uitval bij 100.000 uur bij een Tcase van 75 °C
- Warme start
- Opstarttijd <2 s
- Bestand tegen hoge spanningsspieken (tot 4 kV)
- Geschikt voor Klasse I en II armaturen
- Levensduur TL5 Xtra lamp is 45.000 uur i.p.v. 30.000 uur (10% uitval bij 3 uur schakelcyclus) wanneer de lamp bedreven wordt met een Xtreme voorschakelapparaat
- Energy Efficiency Index (EEI) A2

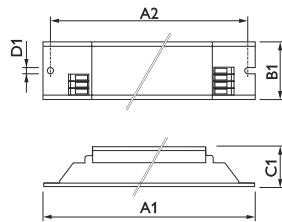

Afmetingen in mm.

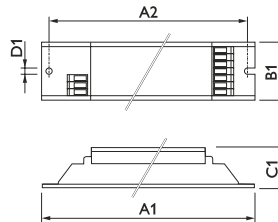

Afmetingen in mm.

HF-P II Xtreme

Afm. no.	A1 Nom	A2 Nom	B1 Nom	C1 Nom	D1 Nom
1	360	350	30	28	5
2	425	415	30	28	5

## Bestelgegevens

### TL5 1 lamp

EOC	Type aanduiding	Typenummer	MOQ	VRG code	Richtprijs	Afm. no.
91423130	HF-P Xt 149 TL5 EII 220-240V 50/60Hz	HFPXT149TL5EII	12	BE	75,10	1
91440830	HF-P Xt 180 TL5 EII 220-240V 50/60Hz	HFPXT180TL5EII	12	BE	89,55	1

### TL5 2 lampen

EOC	Type aanduiding	Typenummer	MOQ	VRG code	Richtprijs	Afm. no.
91431630	HF-P Xt 254 TL5 EII 220-240V 50/60Hz	HFPXT254TL5EII	12	BE	88,80	1
91202230	HF-P Xt 236 TL-D EII 220-240V 50/60Hz	HFPXT236TLDEII	12	BE	80,50	2

### TL-D 1 lamp

EOC	Type aanduiding	Typenummer	MOQ	VRG code	Richtprijs	Afm. no.
91200830	HF-P Xt 136 TL-D EII 220-240V 50/60Hz	HFPXT136TLDEII	12	BE	68,25	1
91204630	HF-P Xt 158 TL-D EII 220-240V 50/60Hz	HFPXT158TLDEII	12	BE	68,25	1

### TL-D 2 lampen

EOC	Type aanduiding	Typenummer	MOQ	VRG code	Richtprijs	Afm. no.
91442230	HF-P Xt 280 TL5 EII 220-240V	HFPXT280TL5EII	12	BE	111,60	1
91206030	HF-P Xt 258 TL-D EII 220-240V 50/60Hz	HFPXT258TLDEII	12	BE	80,50	1

# HF-PERFORMER II Intelligent TL5 HE/HO

- Compacte elektronische, multi-wattage voorschakelapparatuur voor TL5 fluorescentielampen
- Geen knippering van de lamp
- Constante lichtstroom
- 10% uitval bij 50000 uur bij een Tcase van 75 °C.
- Opstarttijd < 1 s
- Energy Efficiency Index (EEI) A2

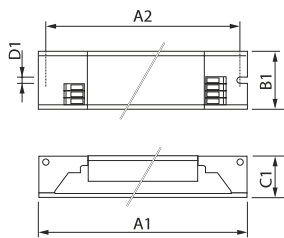

Afmetingen in mm.

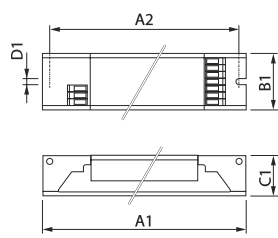

Afmetingen in mm.

HF-P II Intelligent TL5

Afm. no.	A1 Nom	A2 Nom	B1 Nom	C1 Nom	D1 Nom	Afm. no.	A1 Nom	A2 Nom	B1 Nom	C1 Nom	D1 Nom
1	360	350	30	22	5	2	360	350	30	22	5
						3	425	415	30	22	5

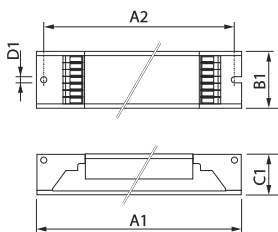

Afmetingen in mm.

Afm. no.	A1 Nom	A2 Nom	B1 Nom	C1 Nom	D1 Nom
4	360	350	30	22	5

## Bestelgegevens

1 lamp							
EOC	Type aanduiding	Typenummer	MOQ	VRG code	Richtprijs	Afm. no.	
91494130	HF-Pi 1 14/21/24/39 TL5 EII 220-240V	HFPI11439TL5EII	12	BE	40,35	1	
91496530	HF-Pi 1 28/35/49/54 TL5 EII 220-240V	HFPI12854TL5EII	12	BE	40,35	1	
86249200	HF-Pi 1 28/35/49/80 TL5 EII	HFPI12880TL5EII	12	BE	52,35	1	

2 lampen							
EOC	Type aanduiding	Typenummer	MOQ	VRG code	Richtprijs	Afm. no.	
91500930	HF-Pi 2 14/21/24/39 TL5 EII 220-240V	HFPI21439TL5EII	12	BE	44,55	2	
91502330	HF-Pi 2 28/35/49/54 TL5 EII 220-240V	HFPI22854TL5EII	12	BE	44,55	2	
86250800	HF-Pi 2 28/35/49/80 TL5 EII	HFPI22880TL5EII	12	BE	57,90	3	

3/4 lampen							
EOC	Type aanduiding	Typenummer	MOQ	VRG code	Richtprijs	Afm. no.	
88775400	HF-Pi 3/4 14/24 TL5/PL-L EII 220-240V	HFPI341424TL5	12	BE	44,55	4	

# HF-PERFORMER III TL5

- Compacte elektronische, multi-wattage voorschakelapparatuur voor TL5 fluorescentielampen
- Geen knippering van de lamp
- Constante lichtstroom
- 10% uitval bij 50.000 uur bij een Tcase van 75 °C
- Opstarttijd < 1 s
- Energy Efficiency Index (EEI) A2 BAT

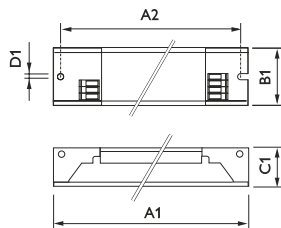

HF-P TL5

Afmetingen in mm.

Afm. no.	A1 Nom	A2 Nom	B1 Nom	C1 Nom	D1 Nom
1	360	350	30	22	5
2	360	350	30	21	5
3	425	415	30	21	5
4	280	265	39	21	5

## Bestelgegevens

1 lamp		Typenummer	MOQ	VRG	Richtprijs	Afm.
EOC	Type aanduiding		code			no.
90504500	HF-P 1 14-35 TL5 HE III 220-240V	HFP11435TL5III	12	BE	37,45	1
95224700	HF-P 1 24/39 TL5 III 220-240V 50/60Hz	HFP12439TL5III	12	BE	37,45	2
86319200	HF-P 149 TL5 HO III 220-240V 50/60Hz IDC	HFP149TL5III	12	BE	37,45	1
86348200	HF-P 154/155 TL5 HO/PLL III 220-240V IDC	HFP15455TL5PLL	12	BE	37,45	1
95228500	HF-P 180 TL5 III 220-240V 50/60Hz	HFP180TL5PLLIII	12	BE	44,15	2

2 lampen		Typenummer	MOQ	VRG	Richtprijs	Afm.
EOC	Type aanduiding		code			no.
90503800	HF-P 2 14-35 TL5 HE III 220-240V	HFP21435TL5III	12	BE	41,65	1
95226100	HF-P 2 24/39 TL5 III 220-240V 50/60Hz	HFP22439TL5III	12	BE	41,65	2
86347500	HF-P 249 TL5 HO III 220-240V 50/60Hz IDC	HFP249TL5III	12	BE	41,65	1
86351200	HF-P 254/255 TL5 HO/PLL III 220-240V IDC	HFP25455TL5PLL	12	BE	41,65	1
95230800	HF-P 280 TL5/PL-L III 220-240V 50/60Hz	HFP280TL5PLLIII	12	BE	51,55	3

3/4 lampen		Typenummer	MOQ	VRG	Richtprijs	Afm.
EOC	Type aanduiding		code			no.
72125300	HF-P 3/4 14 TL5 III 220-240V 50/60Hz IDC	HFP3/414TL5EIII	10	BE	45,10	4



# HF-SELECTALUME II TL5

- Compacte elektronische, multi-wattage voorschakelapparatuur voor TL5 fluorescentielampen
- Geen knippering van de lamp
- Constante lichtstroom
- 10% uitval bij 30.000 uur bij een Tcase van 75 °C
- Opstarttijd < 1,5 s
- Energy Efficiency Index (EEI) A3

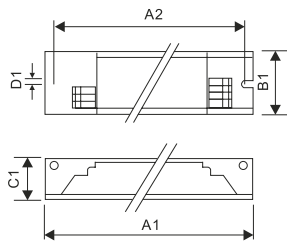

HF-S 214 TL5

Afmetingen in mm.

Afm. no.	A1 Nom	A2 Nom	B1 Nom	C1 Nom	D1 Nom
1	280	265	30	22	5
2	280	265	39	22	5
3	280	265	30	21	5

## Bestelgegevens

EOC	Type aanduiding	Typenummer	MOQ	VRG code	Richtprijs	Afm. no.
75842600	HF-S 114-35 TL5 HE II 220-240V	HFS11435TL5HEII	12	BE	34,75	
75846400	HF-S 180 TL5/PL-L II 220-240V 50/60Hz	HFS180TL5PLLEII	12	BE	40,50	
75844000	HF-S 214-35 TL5 HE II 220-240V	HFS21435TL5HEII	12	BE	38,60	

### 1 lamp

EOC	Type aanduiding	Typenummer	MOQ	VRG code	Richtprijs	Afm. no.
90558800	HF-S 149 TL5 II 220-240V 50/60Hz	HFS149TL5	12	BE	34,75	3
90561800	HF-S 154 TL5 II 220-240V 50/60Hz	HFS154TL5	12	BE	34,75	3

### 2 lampen

EOC	Type aanduiding	Typenummer	MOQ	VRG code	Richtprijs	Afm. no.
90560100	HF-S 249 TL5 II 220-240V 50/60Hz	HFS249TL5	12	BE	38,60	3
90562500	HF-S 254 TL5 II 220-240V 50/60Hz	HFS254TL5	12	BE	38,60	3

### 3/4 lampen

EOC	Type aanduiding	Typenummer	MOQ	VRG code	Richtprijs	Afm. no.
88335000	HF-S 3/414 TL5 II 220-240V 50/60Hz	HFS3414TL5	10	BE	41,80	2
93937800	HF-S 3/424 TL5 II 220-240V 50/60Hz	HFS3424TL5	10	BE	41,80	2

# HF-PERFORMER III TL-D

- Compacte elektronische, multi-wattage voorschakelapparatuur voor TL5 fluorescentielampen
- Geen knippering van de lamp
- Constante lichtstroom
- 10% uitval bij 30.000 uur bij een Tcase van 75 °C
- Opstarttijd < 1,5 s
- Energy Efficiency Index (EEI) A3

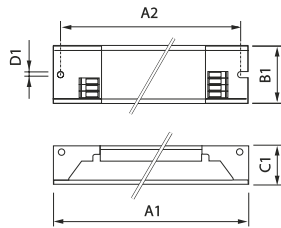

HF-P TL-D

Afmetingen in mm.

Afm. no.	A1 Nom	A2 Nom	B1 Nom	C1 Nom	D1 Nom
1	280	265	30	28	5
2	280	265	40	28	5

## Bestelgegevens

1 lamp		Typenummer	MOQ	VRG code	Richtprijs	Afm. no.
EOC	Type aanduiding					
91164000	HF-P 118/136 TL-D III 220-240V 50/60 Hz	HFP136TLDIII	12	BE	34,00	1
91170100	HF-P 158 TL-D III 220-240V 50/60Hz IDC	HFP158TLDIII	12	BE	34,00	1
2 lampen		Typenummer	MOQ	VRG code	Richtprijs	Afm. no.
EOC	Type aanduiding					
91166400	HF-P 218/236 TL-D III 220-240V 50/60 Hz	HFP236TLDIII	12	BE	37,20	1
91172500	HF-P 258 TL-D III 220-240V 50/60Hz IDC	HFP258TLDIII	12	BE	37,20	1
3/4 lampen		Typenummer	MOQ	VRG code	Richtprijs	Afm. no.
EOC	Type aanduiding					
91162600	HF-P 3/418 TL-D III 220-240V 50/60Hz IDC	HFP3418TLDIII	10	BE	40,20	2

# HF-SELECTALUME II TL-D

- Compacte elektronische, multi-wattage voorschakelapparatuur voor TL-D fluorescentielampen
- Geen knippering van de lamp
- Constante lichtstroom
- 10% uitval bij 30.000 uur bij een Tcase van 75 °C
- Opstarttijd < 1,2 s
- Energy Efficiency Index (EEI) A3

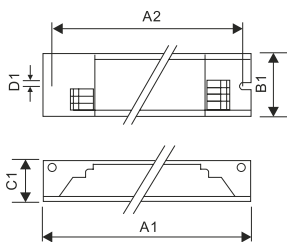

HF-S 158 TL-D

Afmetingen in mm.

Afm. no.	A1 Nom	A2 Nom	B1 Nom	C1 Nom	D1 Nom
1	280	265	30	29	5
2	280	265	30	28	5
3	280	265	39	28	5

## Bestelgegevens

### 1 lamp

EOC	Type aanduiding	Typenummer	MOQ	VRG code	Richtprijs	Afm. no.
90551900	HF-S 118/136 TL-D II 220-240V 50/60Hz	HFS136TLD	12	BE	31,50	2
89739500	HF-S 158 TL-D II 220-240V 50/60Hz	HFS158TLD	12	BE	31,50	1

### 2 lampen

EOC	Type aanduiding	Typenummer	MOQ	VRG code	Richtprijs	Afm. no.
90552600	HF-S 218 TL-D II 220-240V 50/60Hz	HFS218TLD	12	BE	34,50	2
90553300	HF-S 218/236 TL-D II 220-240V 50/60Hz	HFS236TLD	12	BE	34,50	2
89746300	HF-S 258 TL-D II 220-240V 50/60Hz	HFS258TLD	12	BE	34,50	1

### 3/4 lampen

EOC	Type aanduiding	Typenummer	MOQ	VRG code	Richtprijs	Afm. no.
90555700	HF-S 3/4 18 TL-D II 220-240V 50/60Hz	HFS3418TLD	10	BE	37,25	3

# HF-PERFORMER III PL-T/C

- Compacte elektronische, multi-wattage voorschakelapparatuur voor TL-D fluorescentielampen
- Geen knippering van de lamp
- Constante lichtstroom
- 10% uitval bij 30.000 uur bij een Tcase van 75 °C
- Opstarttijd < 1,2 s
- Energy Efficiency Index (EEI) A3



HF-P

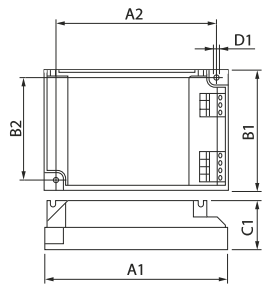

Afmetingen in mm.

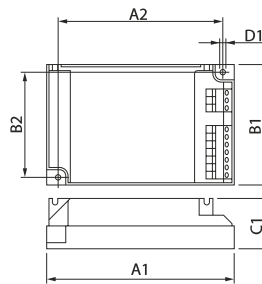

Afmetingen in mm.

Afm. no.	A1 Nom	A2 Nom	B1 Nom	B2 Nom	C1 Nom	D1 Nom	Afm. no.	A1 Nom	A2 Nom	B1 Nom	B2 Nom	C1 Nom	D1 Nom
1	104	94	68	58	30	5	2	104	94	68	58	30	5

## Bestelgegevens

2 lampen	EOC	Type aanduiding	Typenummer	MOQ	VRG code	Richtprijs	Afm. no.
		HF-P 1/218 PL-T/C III 220-240V	HFP218PLTCEIII	12	BE	44,15	2

# HF-PERFORMER II PL-T/C/R/L/TL5C



- Compacte elektronische, multi-wattage voorschakelapparatuur voor fluorescentielampen: PL-T/C/R/L/TL5C
- Geen flikkering van de lamp
- Constante lichtstroom
- 10% uitval bij 50.000 uur bij een Tcase van 75 °C
- Warme start
- Opstarttijd < 0,5 s
- Energy Efficiency Index (EEI) A2



HF-P II

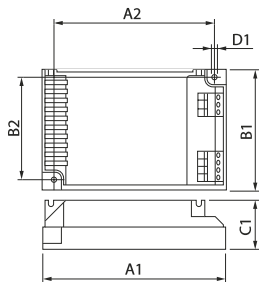

Afmetingen in mm.

Afm. no.	A1 Nom	A2 Nom	B1 Nom	B2 Nom	C1 Nom	D1 Nom
1	103	94	67	58	30	5

## Bestelgegevens

1 lamp							
EOC	Type aanduiding	Typenummer	MOQ	VRG code	Richtprijs	Afm. no.	
91407130	HF-P 1 13-17 PL-T/C/R EII 220-240V	HFP11317PLTCR	12	BE	39,45	1	
91397530	HF-P 1 22-42 PL-T/C/L/TL5C EII 220-240V	HFP12242TL5CPL	12	BE	39,45	1	
2 lampen							
EOC	Type aanduiding	Typenummer	MOQ	VRG code	Richtprijs	Afm. no.	
91409530	HF-P 2 13-17 PL-T/C/R EII 220-240V	HFP21317PLTCR	12	BE	44,05	1	
91399930	HF-P 2 22-42 PL-T/C/L/TL5C EII 220-240V	HFP22242TL5CPL	12	BE	44,05	1	

# HF-Selectalume II for PL-T/C Strain Relief

- Geen knippering van de lamp
- Constante lichtstroom
- 10% uitval bij 30.000 uur bij een Tcase van 75 °C
- Opstarttijd < 1,2 s
- Energy Efficiency Index (EEI) A3



- Compacte elektronische, multi-wattage voorschakelapparatuur voor PL-T/C fluorescentielampen.

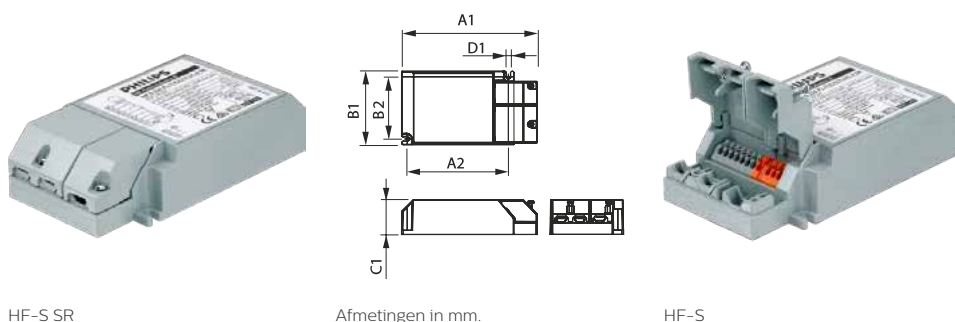

HF-S SR

Afmetingen in mm.

HF-S

Afm. no.	A1 Nom	A2 Nom	B1 Nom	B2 Nom	C1 Nom	D1 Nom
1	126	94	68	58	32	4

## Bestelgegevens

EOC	Type aanduiding	Typenummer	MOQ	VRG code	Richtprijs	Afm. no.
16963500	HF-S 1/218 PL-T/C II SR 220-240V 50/60Hz	HFS218PLTIISR	12	BE	43,30	1
16959800	HF-S 1/226 PL-T/C II SR 220-240V 50/60Hz	HFS226PLTL5CSR	12	BE	43,30	1

# HF-PERFORMER III PL-L

- Compacte elektronische voorschakelapparatuur voor PL-L compacte fluorescentielampen
- Geen knippering van de lamp
- Constante lichtstroom
- 10% uitval bij 50.000 uur bij een Tcase van 75 °C
- Opstarttijd < 1 s
- Energy Efficiency Index (EEI) A2 BAT

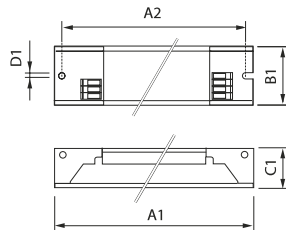

HF-P PL-L

Afmetingen in mm.

Afm. no.	A1 Nom	A2 Nom	B1 Nom	C1 Nom	D1 Nom
1	280	265	30	28	5
2	360	350	30	22	5
3	425	415	30	21	5

## Bestelgegevens

1 lamp		Typenummer	MOQ	VRG code	Richtprijs	Afm. no.
EOC	Type aanduiding					
86348200	HF-P 154/155 TL5 HO/PLL III 220-240V IDC	HFP15455TL5PLL	12	BE	37,45	1
95228500	HF-P 180 TL5 III 220-240V 50/60Hz	HFP180TL5PLLIII	12	BE	44,15	2
2 lampen		Typenummer	MOQ	VRG code	Richtprijs	Afm. no.
EOC	Type aanduiding					
86351200	HF-P 254/255 TL5 HO/PLL III 220-240V IDC	HFP25455TL5PLL	12	BE	41,65	1
95230800	HF-P 280 TL5/PL-L III 220-240V 50/60Hz	HFP280TL5PLLIII	12	BE	51,55	3



# HF-PERFORMER TL5 Circular

- Compacte elektronische voorschakelapparatuur voor TL5 Circular fluorescentielampen
- Geen flinkering van de lamp
- Constante lichtstroom
- 10% uitval bij 50.000 uur bij een Tcase van 65 °C
- Warme start
- Opstarttijd < 2 s
- Energy Efficiency Index (EEI) A2

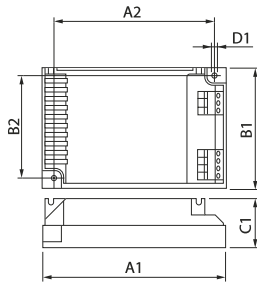

HF-P

Afmetingen in mm.

Afm. no.	A1 Nom	A2 Nom	B1 Nom	B2 Nom	C1 Nom	D1 Nom
1	103	94	67	58	30	5

## Bestelgegevens

EOC	Type aanduiding	Typenummer	MOQ	VRG code	Richtprijs	Afm. no.
92776730	HF-P 155 TL5C 220-240V 50/60Hz	HFP155TL5C	36	BE	54,65	1
92778130	HF-P 160 TL5C 220-240V 50/60Hz	HFP160TL5C	36	BE	54,65	1

# HF-Matchbox RED

- Compacte elektronische voorschakelapparatuur voor TL (4 W - 18 W), TL5 (14 W - 24 W) en PL (5 W - 24 W) (compact) fluorescentielampen
- Geen flikkering van de lamp
- Constante lichtstroom
- Warme start



HF-Matchbox RED

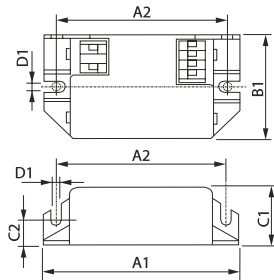

Afmetingen in mm.

Afm. no.	A1 Nom	A2 Nom	B1 Nom	C1 Nom	C2 Nom	D1 Nom
1	94	70	40	22	10	5
2	80	70	40	22	10	5

## Bestelgegevens

EOC	Type aanduiding	Typenummer	MOQ	VRG code	Richtprijs	Afm. no.
15271200	HF-M RED 209 SH	HFMRED209SH	50	BE	28,90	
93142930	HF-M RED 109 SH TL/PL-S 230-240V	HFMRED109SH	50	BE	21,80	2
93140530	HF-M RED 114 SH TL/TL5/PL-C/S 230-240V	HFMRED114SH	50	BE	21,80	2
92802330	HF-M RED 118 SH PL-C/PL-T 230-240V	HFMRED118SH	50	BE	21,80	2
91040030	HF-M RED 124 SH TL/TL5/PL-L 230-240V	HFMRED124SH	50	BE	26,85	1

# HF-Matchbox BLUE

- Compacte elektronische voorschakelapparatuur voor TL-D (15 W - 18 W), TL5 (21 W - 28 W) en PL-L (18 W - 24 W) (compact)fluorescentielampen
- Geen flikkering van de lamp
- Constante lichtstroom
- Koude start



HF-M

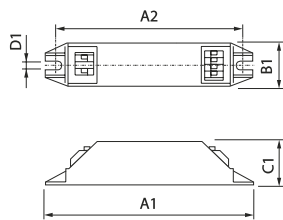

Afmetingen in mm.



HF-M 114/18/24 PL-C/PL-T/TL/TL5/PL-L

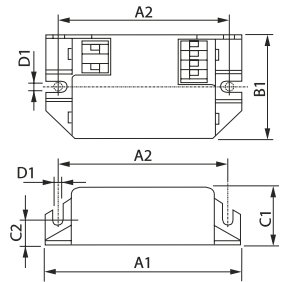

Afmetingen in mm.

Afm. no.	A1 Nom	A2 Nom	B1 Nom	C1 Nom	D1 Nom	Afm. no.	A1 Nom	A2 Nom	B1 Nom	C1 Nom	C2 Nom	D1 Nom
1	187	176	22	22	5	3	94	84	40	22	10	5
2	144	132	22	22	5							

## Bestelgegevens

### Rechthoekige behuizing

EOC	Type aanduiding	Typenummer	MOQ	VRG code	Richtprijs	Afm. no.
53638930	HF-M BLUE 124 SH TL/TL5/PL-L 230-240V	HFM124SH	50	BE	22,50	3

### Langwerpige behuizing

EOC	Type aanduiding	Typenummer	MOQ	VRG code	Richtprijs	Afm. no.
53680830	HF-M BLUE 109 LH TL/PL-S 230-240V	HFM109LH	50	BE	17,90	2
53682230	HF-M BLUE 114 LH TL/PL-S/PL-C 230-240V	HFM114LH	50	BE	17,90	2
53646430	HF-M BLUE 121 LH TL5 230-240V	HFM121LH	50	BE	22,50	1
53640230	HF-M BLUE 124 LH TL/TL5/PL-L 230-240V	HFM124LH	50	BE	22,50	1
93243330	HF-M BLUE 128 LH TL5 230-240V	HFM128LH	50	BE	22,50	1