

PHILIPS

Sensors

EasySense

Fixture-Mount for Advanced Grouping



The Philips EasySense fixture-mount sensor is the ideal solution for per-fixture control of new light fixtures. It combines occupancy sensing, daylight harvesting and task tuning in a single, compact package for easy OEM fixture assembly. EasySense operates with the established Philips Advance Xitanium SR LED driver standard to make a simple two-wire connection between sensor and driver, thus eliminating the need for multiple components and auxiliary devices. The result is a cost-effective and easy-to-design-in solution ideal for energy-savings and code-compliance strategies. An intuitive app makes configuration and commissioning during and after installation fast and easy using Philips field apps.

EasySense with advanced grouping functionality enables addition of qualified wireless switches. Up to 40 sensors can be grouped to a switch using Philips field apps. In addition to easily adding user control to a space, the grouping feature facilitates auto-off/manual-on and auto-off/partial-on use cases. Furthermore, advanced grouping allows scene setting (e.g., presentation mode for a conference room), as well as occupancy sharing (i.e., fixtures within a group can be programmed to remain at prescribed light levels so long as occupancy is detected anywhere in the group).

EasySense for advanced grouping (SNS200) is also DLC qualified and listed in the QPL for Networked Lighting Controls.

Commercial Product Name	Order Code
EasySense Fixture-Mount Sensor	SNS200

EasySense fixture-mount sensor

Features

- Occupancy sensing, daylight harvesting and task tuning in one device
- Scene setting and occupancy sharing
- Compact size, 2-wire connection
- Operates with Philips Advance Xitanium SR LED drivers and qualified wireless switches
- Configuration of sensor parameters – if desired – using NFC or IR via intuitive Android-based Philips field apps
- DLC qualified: Listed on the QPL for Networked Lighting Controls

Benefits

- Combines functionality to reduce need for multiple components
- Quick task tuning in the field to optimize light and power levels
- Enables auto-off/manual-on and auto-off/partial-on application
- Cost-effective solution for energy-savings and code-compliance strategies
- 5-year limited system warranty with Philips Advance Xitanium LED drivers¹
- Configuration and commissioning from the floor

Applications

- Conference rooms
- Individual offices
- Open offices
- Classrooms
- Storage and break areas
- Restrooms
- Lobbies
- Stairways

Product Data

All specifications are typical and at 25°C Tcase unless otherwise specified.

Ordering Information

Order Code	SNS200
Full Product Name	EasySense Fixture-Mount Sensor
Carton Quantity	50 pcs/carton

Physical Information

Overall Dimensions	1.97in x 0.75in x 1.24in / 50mm x 19.0mm x 31.5mm
Housing (Luminaire Hole)	1.73in x 0.67in / 44mm x 17mm (L x w)
Net Weight per Piece	0.6oz / 17gr
Volume Required Inside Luminaire (LxWxH)	1.87in x 0.75in x 0.95in / 50mm x 19mm x 24mm
Color	White
Connectors	(2) Lite-Trap connectors rated for AWG24 to AWG18 solid conductor wire (AWG22-AWG20 for stranded wire)

Electrical Information

Input Voltage	Powered by SR driver low-voltage interface
Current Consumption	13mA
Nominal Power Consumption	200mW
Standby Power	< 1 W on luminaire level, including driver standby power

Occupancy Sensing

Type	Passive infrared (PIR)
Enable/Disable	Default enabled
Occupancy Mode	Auto-on/off, Manual-on/off, Manual-on/auto-off; Red LED indicates occupancy detected
Group Occupancy Sharing	Enabled/disabled
Group Lighting Behavior	Background level, task level
Eco-On Level	5-100%
Hold Time	0.5 - 60 minutes
Viewing Angle	X=72°, Y = 86° (See detection pattern)
Background Light Level	0-100%
Prolong Time	0 minutes - infinity
Grace Fading	0-25 seconds
Response Time/Fading to Switch On/Off	0.7 seconds

Continued on next page.

1. View limited warranty at <http://www.usa.lighting.philips.com/support/support/warranty>.

EasySense fixture-mount sensor

Product Data (continued)

All specifications are typical and at 25°C Tcase unless otherwise specified.

Daylight Sensing	
Enable/Disable	Default enabled
Auto-Calibration	Upon power-up
Viewing Angle	40° (half value sensitivity); 2% cut-off point at 75°
Task Tuning	
Full Light Setting	5-100%
Environment & Approbation	
Operating Ambient Temperature Range	0°C to 55°C
Operating Humidity	0 – 95% non condensing
Storage Temperature	-25°C to 85°C
Storage Humidity	0-95% non condensing
Max Case Temperature (Tcase)	55°C
Agency Approbations	UL, CSA; Tested and approved for use in plenums; FCC ID: 2AF2N-SNS100; IC: 20659-SNS100
Certification	California Title 20
Warranty	5 years
Digital Interface	Xitanium SR
Other	
Wireless Protocol	Zigbee, IEEE 802.15.4
Encryption	AES-128
LED Status Indicators	Red, Yellow. Yellow LED on: Vacancy & Sensor is functional; Red LED on: Occupancy detected
No. Drivers per Sensor	4 max
Max Distance Switch-to-First-Fixture	33ft line-of-sight
Max Distance Fixture-to-Fixture	40ft line-of-sight
No. Switches per Group	5 max
Field Configuration	via NFC or IR, parameters set via Philips field apps

Compatible LED Drivers

Driver Model Number	Description
XI040C110V054VPT1	Xitanium 40W 0.1-1.1A 27-54V 120-277V SR
XI075C200V054VPT1	Xitanium 75W 0.1-2.0A 27-54V 120-277V SR

Specifications available at www.philips.com/xitaniumsr/na.

EasySense fixture-mount sensor

Sensor Dimensions (in./mm)

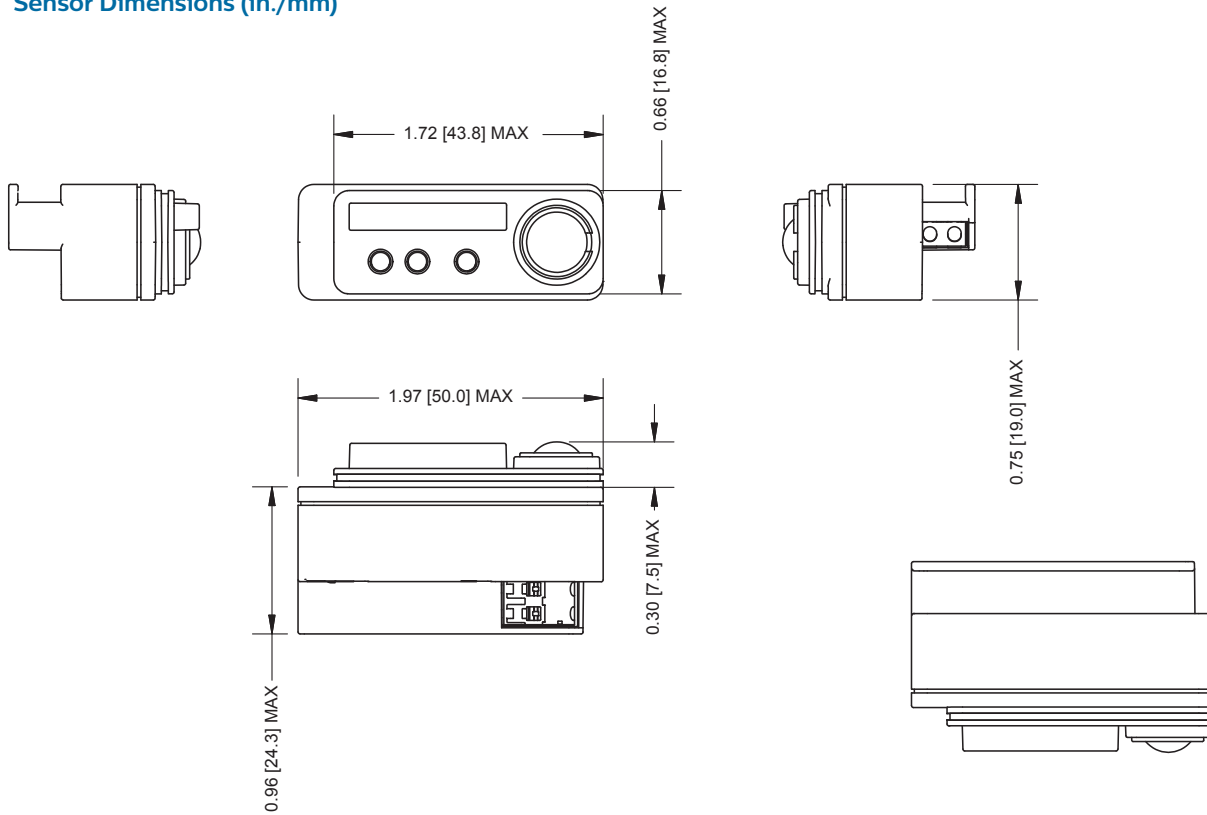

Mounting Dimensions (in./mm)

Mounting in U-shaped slot in sheet metal (max thickness 1 mm), tolerance +0.2mm/-0.0mm

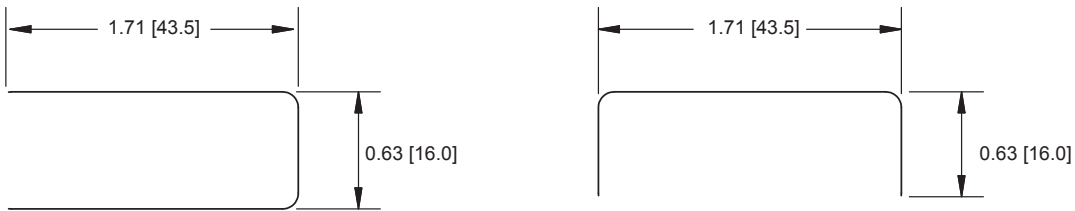

Mounting in cut-out in sheet metal (thickness 0.7 mm to 1.0 mm), tolerance +/-0.2mm

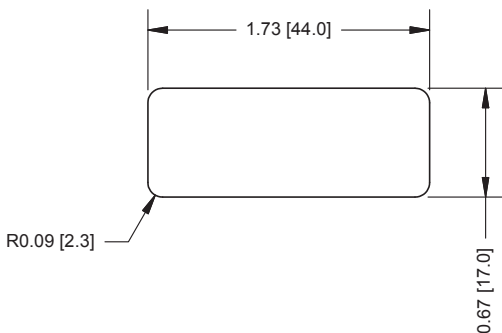

Accessory Mounting Ring

Part Number SMR-50 / Set of 50

- (1) SMR-50 includes a set of (50) mounting rings
- Ordered separately, not included with EasySense
- Dimensions: 53mm x 26mm x 1.5mm



Accessory Mounting Bracket

Part Number SMB-50 / Set of 50

- (1) SMB-50 includes (50) mounting brackets
- Ordered separately, not included with EasySense
- Dimensions: 64.1mm x 25.3mm x 10.3mm

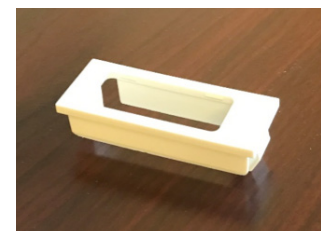

EasySense fixture-mount sensor

Wiring Diagram

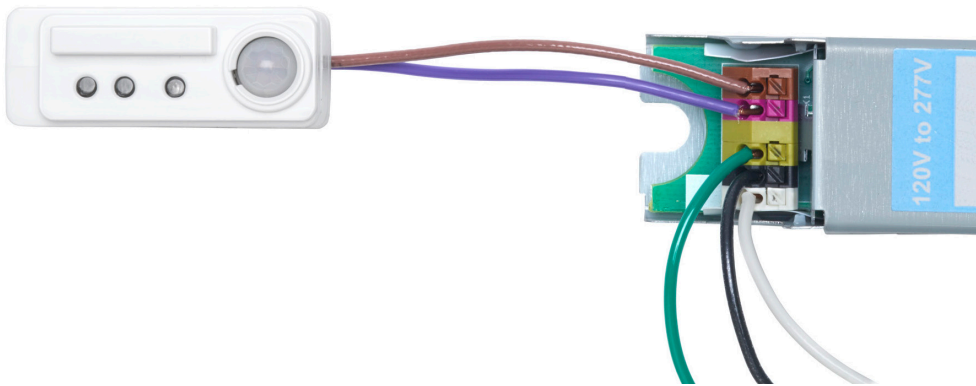
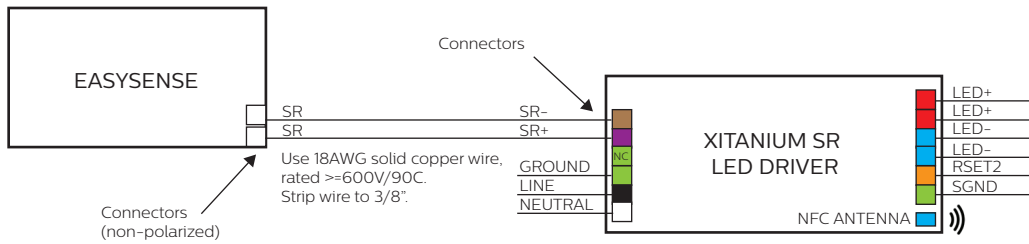

EasySense fixture-mount sensor

Occupancy Sensing

The detection area for the movement sensor can be roughly divided into two parts:

- Minor movement (person moving $\leq 3.0'$ /s or 0.9m/s).
- Major movement (person moving $\geq 3.0'$ /s or 0.9m/s).

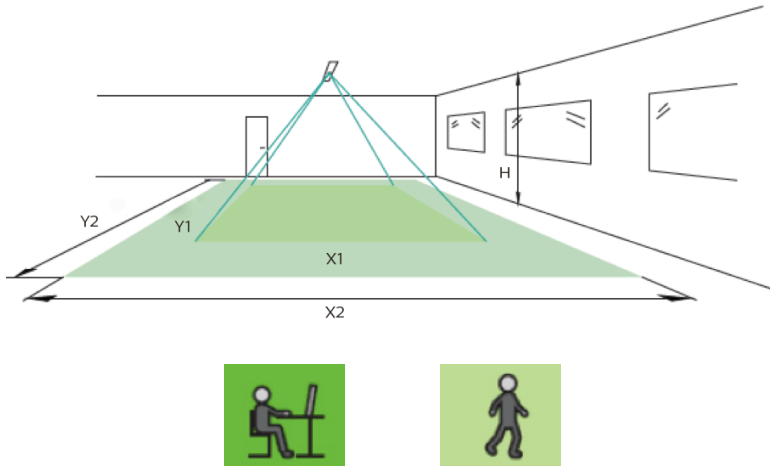

Height	Minor Movement		Major Movement	
	Y1	X1	Y2	X2
8'/2.4m	10'/2.9m	9'/2.7m	15'/4.5m	9'/2.9m
10'/3m	12'/3.6m	11'/3.4m	18'/5.4m	12'/3.6m

Note: Longer dimension of detection area (Y1, Y2) is parallel to longer dimension of EasySense.

EasySense fixture-mount sensor

Occupancy Sensing (continued)

Full-On Sequence (Default)

Eco-On Level = Task Level

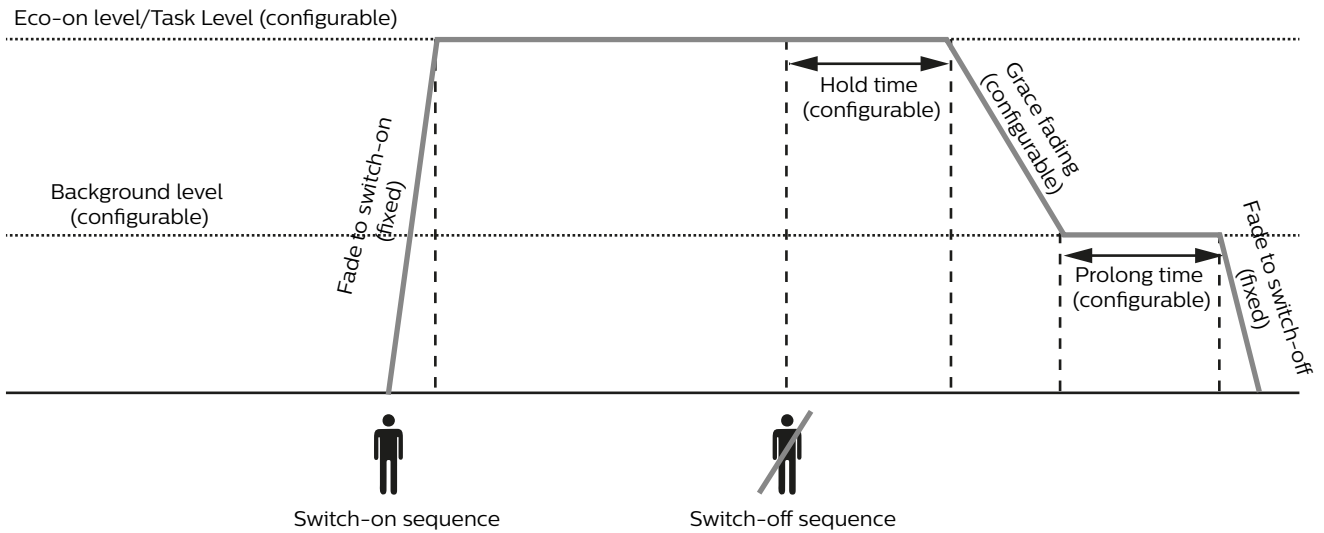

Partial-On Sequence (Configurable)

Eco-On Level < Task Level

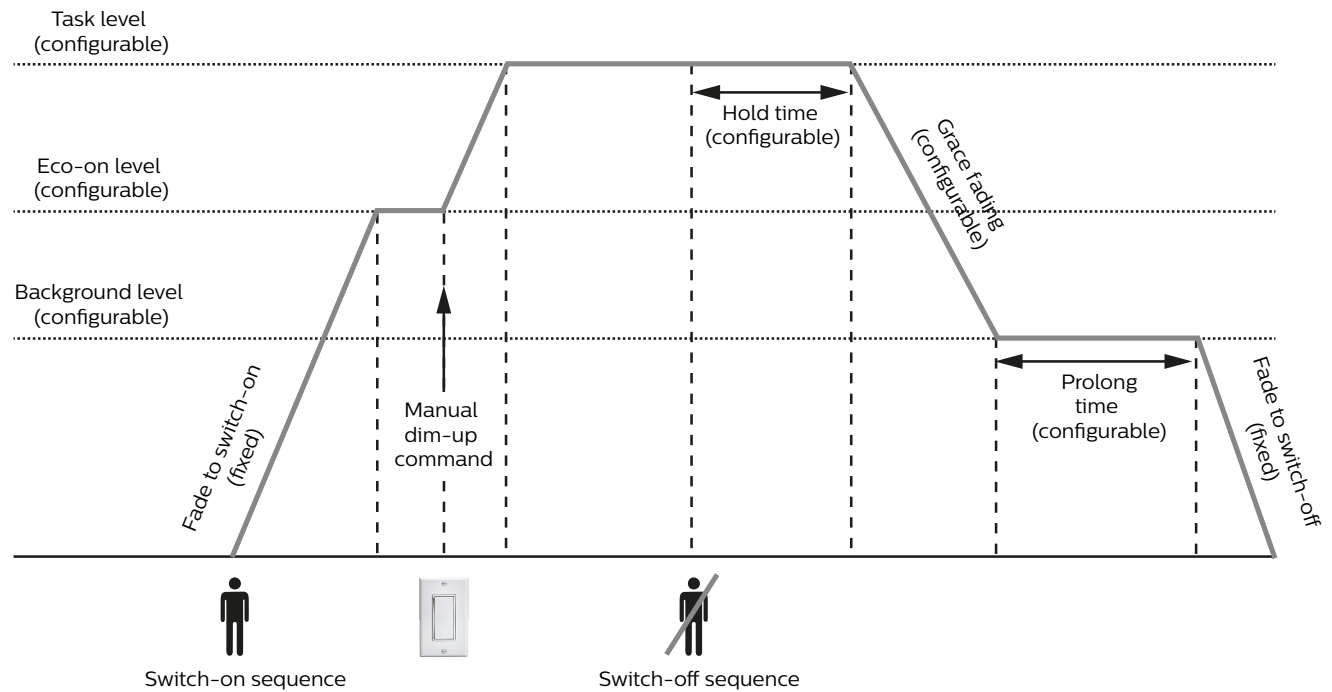

EasySense fixture-mount sensor

Daylight Sensor

The light sensor measures the total amount of light in a circular field of $\approx 80\%$ of the PIR detection area. The following aspects should be observed during installation:

- Minimum distance from the window $\geq 2.0/0.6\text{m}$.
- Prevent light reflections from outside entering the sensor (for example sunlight reflection on a car bonnet) as this will lead to incorrect light regulation.

As a guideline the formula $0.72 \times H$ can be used to calculate the minimum distance between the window and sensor whereby H is the height from the bottom of the window to the ceiling.

Photosensor Spatial Response

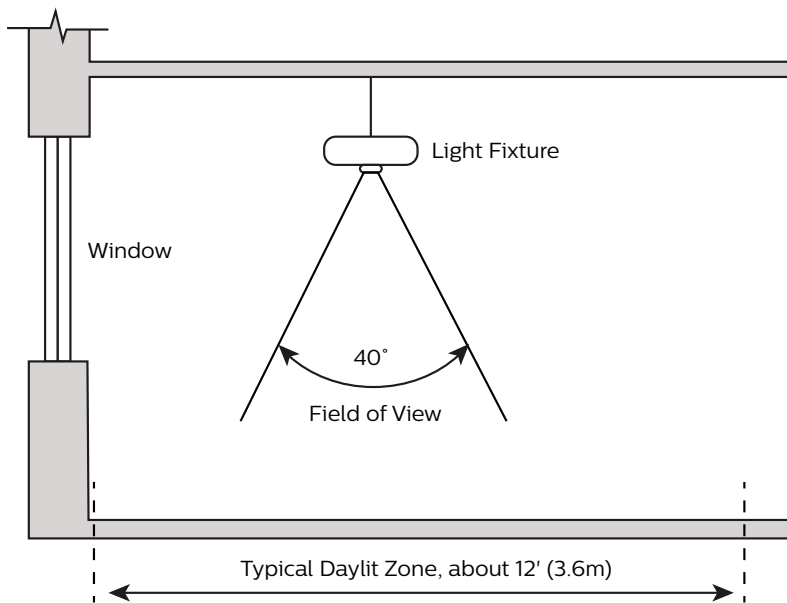

Photosensor Spectral Response

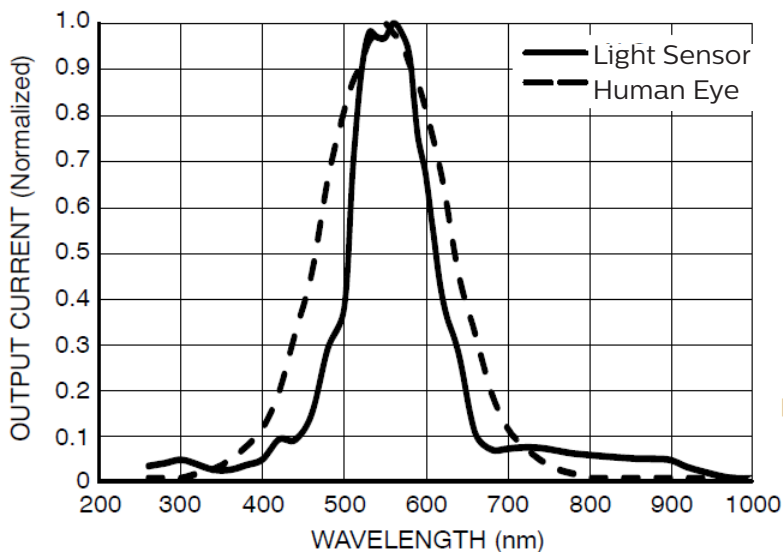

EasySense fixture-mount sensor

Philips Field Apps: EasySense NFC and EasySense IR

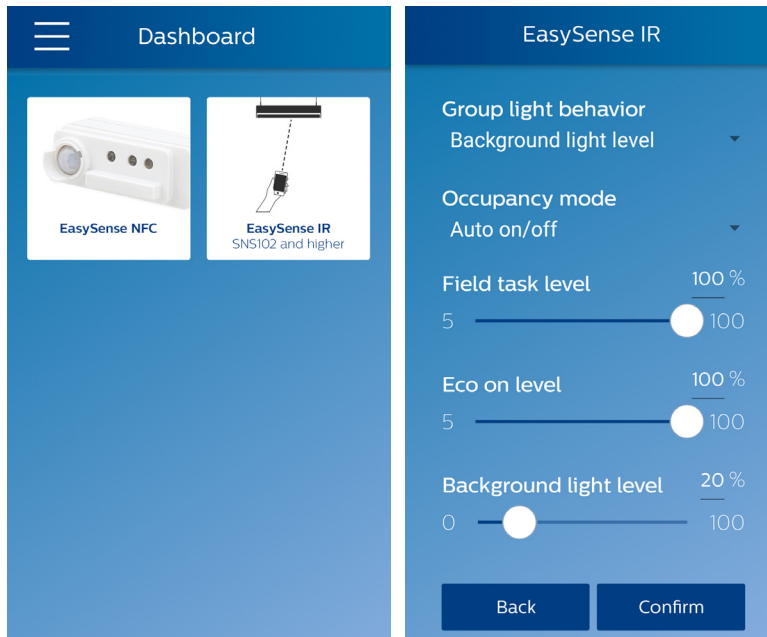

EasySense parameters can be configured via Philips field apps. Two versions are available:

1. EasySense NFC – This app allows configuring EasySense parameters only when you can physically access the sensor with a smartphone.
2. EasySense IR – This app allows configuring EasySense parameters plus enables grouping to a wireless switch, which can be done with the IR feature of applicable phones from floor level.

You must first register for the app to receive a username and password, then download Philips field apps from the Google Play Store. Refer to www.philips.com/easysense for details, including applicable Android phones and user manuals.

Default Factory Settings

Occupancy Detection	Auto-on, Enabled
Daylight-Based Control	Auto-on, Enabled
LED Indicator	Enabled
Occupancy Mode	Auto-on/off
Group Occupancy Sharing	Enabled
Group Lighting Behavior	Background level
Field Task Tuning	100%
Eco-On Level	100%
Background Light Level	20%
Hold Time	15 minutes
Prolong Time	15 minutes
Grace Fading	10 seconds
Fade to Switch-On	0.7 seconds
Fade to Switch-Off	0.7 seconds

EasySense fixture-mount sensor

Ceiling-Mount Option

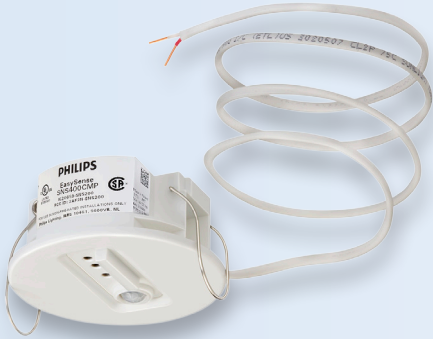

Sensor Part Number

Order Code	SNS200CMP (516666)
Full Product Name	EasySense Ceiling-Mount Sensor
Carton Quantity	1 pc/carton
Assembly	Includes sensor pre-assembled in ceiling mounting plate with leads ready for field installation
Net Weight per Piece	2.6oz / 75gr
Color	White
No. Drivers per Sensor	Four drivers per sensor max, polarity must be maintained

Note: For use in non-fire-rated installations only.

Wiring Diagram

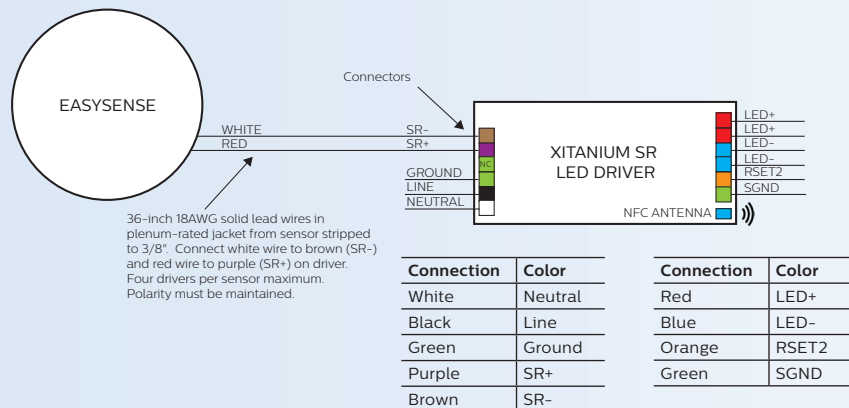

Note: Refer to www.philips.com/easysense for quick installation guide.

EasySense fixture-mount sensor

Ceiling-Mount Option

Sensor Dimensions (in/mm)

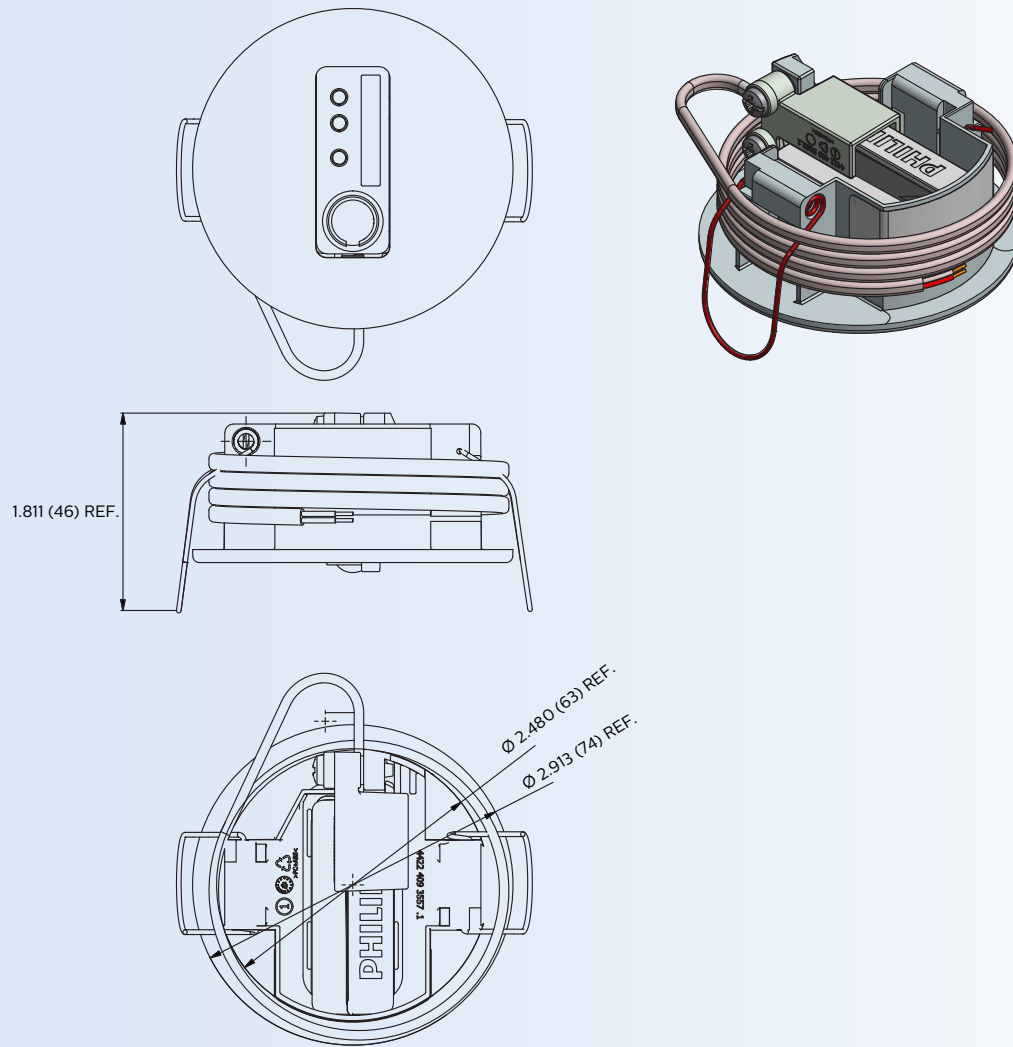

EasySense fixture-mount sensor

Compatible Wireless Switches

Manufacturer	Model	Style
Illumra	ZBT-S1AWH	Single Rocker Self Powered
	ZBT-S2AWH	Dual Rocker Self Powered
Magnum Energy Solutions	MZ-SW1	Single Rocker Self Powered
	MZ-SW2	Dual Rocker Self Powered
	MZ-ASW1	Single Rocker Self Powered
	MZ-ASW2	Dual Rocker Self Powered
	MZ-ESRP	Single Rocker Self Powered
	MZ-EDRP	Dual Rocker Self Powered

- Max no. sensors per switch: 40
- Manufacturers links to product information:
 - o Illumra (www.illumra.com/easysense)
 - o Magnum Energy Solutions: www.magnumenergysolutions.com/products

Single-Rocker Functions (typical switch shown)

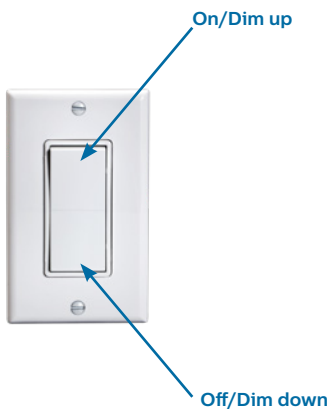

Dual-Rocker Functions (typical switch shown)

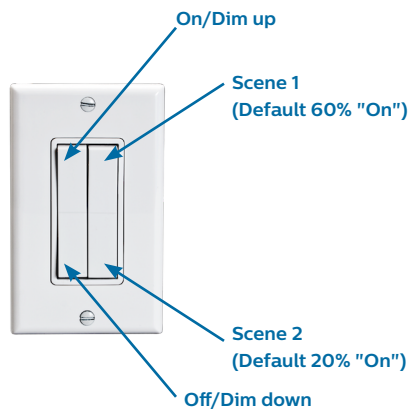

© 2017 Philips Lighting Holding B.V. All rights reserved.
 Philips reserves the right to make changes in specifications and/or to discontinue any product at any time without notice or obligation and will not be liable for any consequences resulting from the use of this publication.
philips.com/easysense



Philips Lighting North America Corporation
 10275 W. Higgins Road, Rosemont IL 60018
 Tel: 800-322-2086 Fax: 888-423-1882
 Customer/Technical Service: 800-372-3331
 OEM Support: 866-915-5886

Philips Lighting Canada Ltd.
 281 Hillmount Rd, Markham, ON, Canada L6C 2S3
 Tel. 800-668-9008