

**PHILIPS
ADVANCE**

LED Driver

Xitanium

20W 0.35-0.5A 42V LE+TE INT
XI020C050V042RNP2



Class P
LED class 2 output
For Dry and Damp Location

Conforms to UL STD 8750
Certified to CAN/CSA STD
C22.2 No. 250.13

The Philips Advance Xitanium range of phase-cut dimming LED drivers are perfectly suited for commercial fittings in downlight and track lighting applications. These models offer the flexibility of precise output of drive currents from selectable settings and are compatible with a variety of electronic low voltage dimmers to deliver reliably smooth dimming performance. The drivers are offered in a compact form factor suitable for use in elegantly unobtrusive fixture designs. Rated for long life with efficient performance, these drivers are excellent design choices for LED downlight fixtures offering the benefits of long-lasting energy savings with low maintenance costs.

Specifications

Input Voltage (Vac)	Output Power (W)	Output Voltage (V)	Output Current (A)	Efficiency@ Max Load and 75°C Case	Max Case Temp. (°C)	Input Current (A)	Max. Input Power (W)	THD @ Max Load (%)	Power Factor @ Max Load	Surge Protection (Combi-Wave, KV)	Envir. Protection Rating
120	20	20 - 42	0.35 - 0.5	85	Life-75°C Max-85°C	0.2	25	<10%	>0.95	2.5	UL damp & dry
277				86		0.1		<25%			

Enclosure

	In. (mm)
Case Length	3.74 (95)
Case Width	1.57 (40)
Case Height	0.98 (25)
Mounting Length	3.35 (85)
Overall Length	

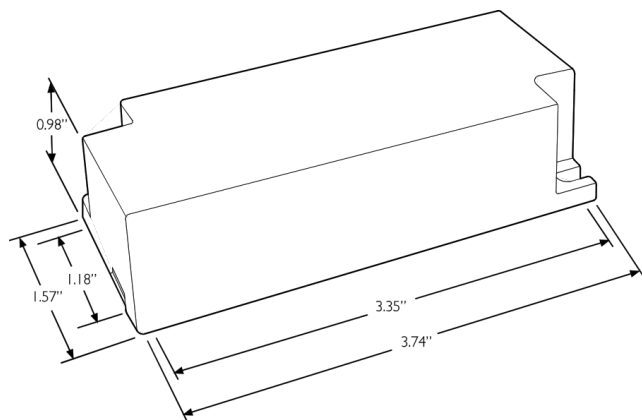

Wiring Diagram

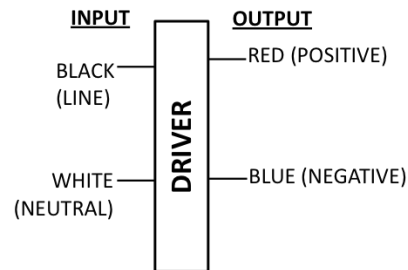

Input and output use lead wires.

Lead-wires are input 18AWG / output 22AWG 105C/600V stranded copper.

Standard lead length is 150mm (±10mm) on all wires outside the can.

All wires have tinned ends.

Dimming	Dimming Range (with specified dimmers)	Minimum Output Current (A)	Other Comments
LE + TE Leading Edge & Trailing Edge	2% ~ 100%	0.007	

Xitanium 20W 0.35-0.5A 42V LE+TE INT

Features

- 50,000+ hour lifetime¹
- UL Class 2 output with adjustable drive current
- Leading edge/Trailing edge dimming
- Compact form factor

Benefits

- Enables easy design-in with excellent thermal performance
- Enables simple, fast, flexible application-specific configurations
- Enables light levels suited for the application
- Enables design of low-profile fixtures

Application

- Indoor downlight and track applications
- Retail, hospitality

Electrical Specifications

All the specifications are typical and at 25°C Tcase unless specified otherwise.

Product Data

Order Information	
Full Product Code	XI020C050V042RNP2M (Mid-Pack, 48pcs/Box), 12NC: 929000766013
Line Frequency	50/60Hz
Min. Mains Voltage Operational	108 Vac
Max. Mains Voltage Operational	305 Vac
Output Information	
Maximum Open Circuit Voltage	< 60Vdc
Output Current Ripple	30% max @ max Iout
Output Current Tolerance (within full output operating range)	350mA: (-10% / +5%) 400mA: (-10% / +5%) 450mA: (-8% / +5%) 500mA: (-8% / +5%) Output Current variation includes effects of line & load regulation, temperature variation and component tolerances
Protections	Short Circuit, Open Circuit Protection for LED + and LED – and Temperature Foldback
Features	
0-10V Dimming	LE + TE dimming
AOC (Adjustable Output Current)	350mA to 500mA via DIP switches (refer to figure & notes in the Electrical Specification section)
Environment & Approbation	
Operating Ambient Temp. Range	-20°C to +50°C
Max. Case Temperature (Tcase)	Max. 85°C, Tcase Life: 75°C
Agency Approbations	UL8750, UL991, CSA250.13-14, C22.2 No. 0.8-12, Class P (UL, CSA, ETL)
Electromagnetic Compliance	FCC Title 47 Part 15 Class A, CAN ICES-005 (A) / NMB-005 (A)
Audible Noise	<24dB Class A
Weight	0.27 Lbs / 0.122 kgs

1. Philips Advance Xitanium LED drivers are manufactured to engineering standards correlating to a designed and average life expectancy of 50,000 hours of operation at maximum rated case temperature. Minimum 90% survivals based on MTBF modeling.

Xitanium 20W 0.35-0.5A 42V LE+TE INT

Electrical Specifications

All the specifications are typical and at 25°C Tcase unless specified otherwise.

LE + TE Dimming

Minimum Dim Level: 2% of Iout (minimum 8mA)

Approved Dimmer List

Manufacturer	Manufacturer Part Number	Type of Dimmer	Min. Number of Drivers per Dimmer	Max. Number of Drivers per Dimmer
Lutron	DV-600P	Leading Edge	1	Dimmers can be loaded up to 80% of their max power rating.
	DVELV-303P	Trailing Edge		
	NTELV-600	Trailing Edge		
	MAELV-600	Trailing Edge		
	SELV-300P	Trailing Edge		
	DVLV-600P	Leading Edge		
	NFTU-5A	Leading Edge		
	CTCL-153P	Leading Edge		
	GL-600H	Leading Edge		
	S-600P	Leading Edge		
	PHPM	277V		

Xitanium 20W 0.35-0.5A 42V LE+TE INT

Electrical Specifications

All the specifications are typical and at 25°C Tcase unless specified otherwise.

AOC (Adjustable Output Current) Settings

The output current of the driver can be adjusted using the two dip switches provided on the bottom of the driver. The below picture shows the switch positions required to set the current to different levels.

Switch 1	Switch 2	Drive Current
OFF	OFF	350mA
OFF	ON	400mA (factory default)
ON	OFF	450mA
ON	ON	500mA

Notes

The driver will be shipped out of factory with a default of 400mA.

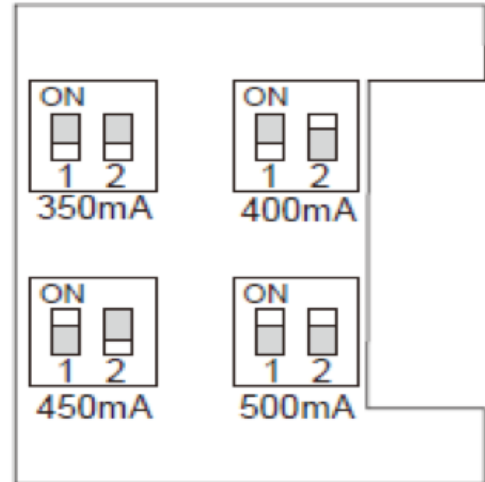

Xitanium 20W 0.35-0.5A 42V LE+TE INT

Electrical Specifications

All the specifications are typical and at 25°C Tcase unless specified otherwise.

Output Current Vs. Driver Case Temperature

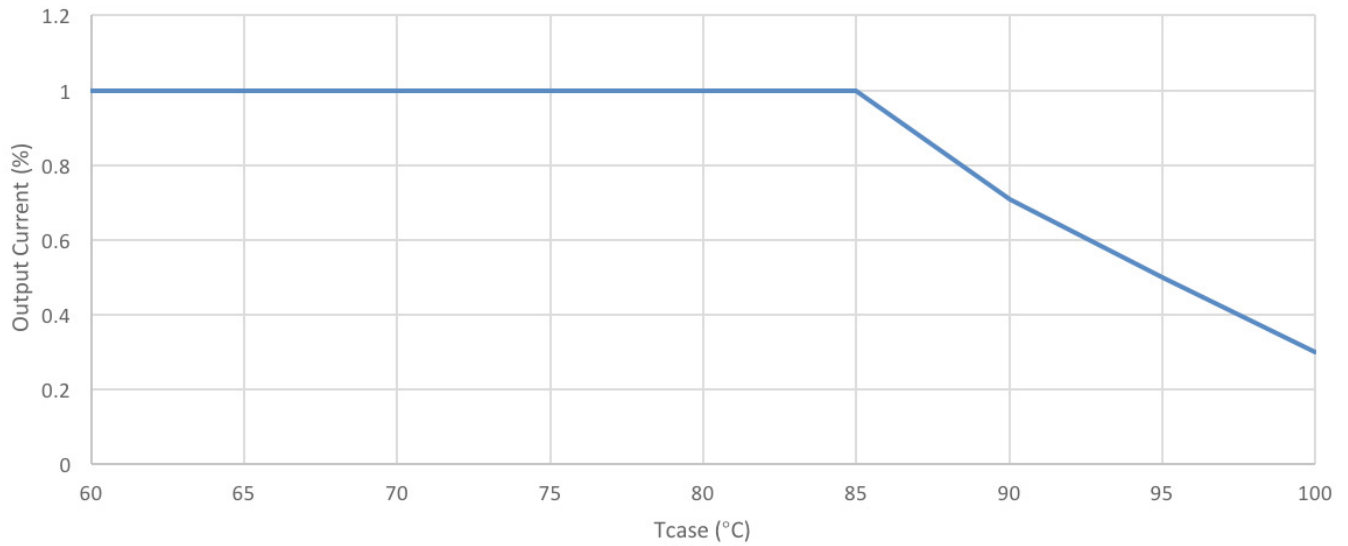

Note: There is $\pm 5^\circ\text{C}$ tolerance on the driver case temperature.

Driver Lifetime Vs. Driver Case Temperature

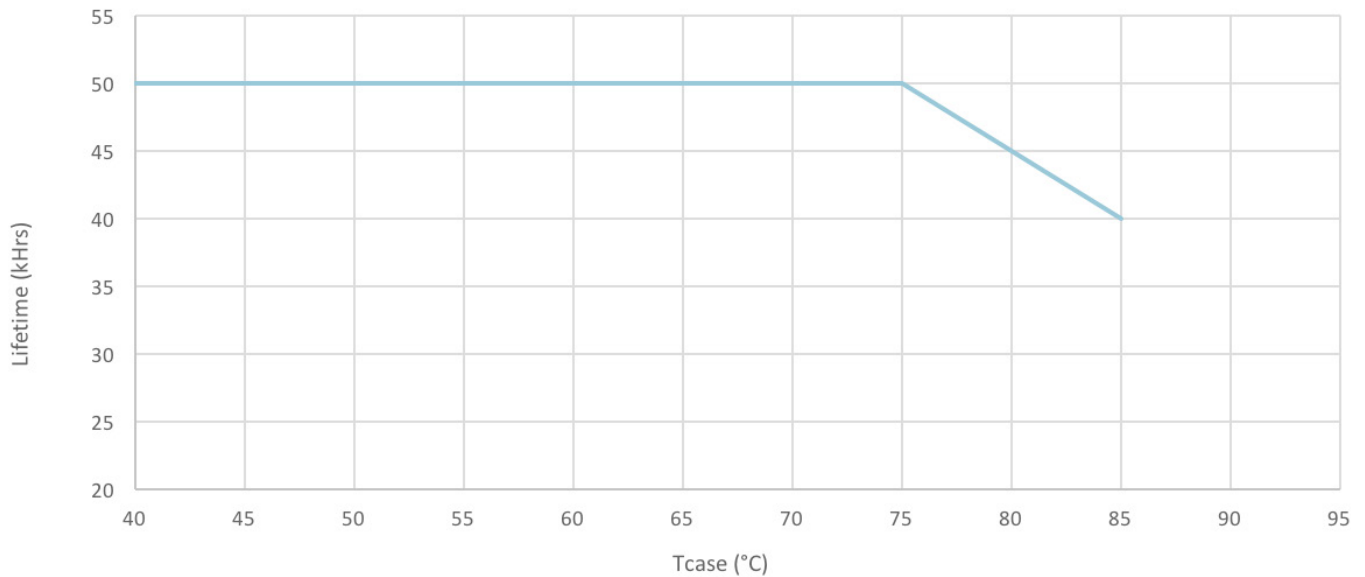

Xitanium 20W 0.35-0.5A 42V LE+TE INT

Performance Characteristics

Based on measurements on a typical sample at 70°C case. The accuracy of the measurements is within the tolerance of the measurement instruments.

Efficiency Vs. Output Voltage at 120Vac

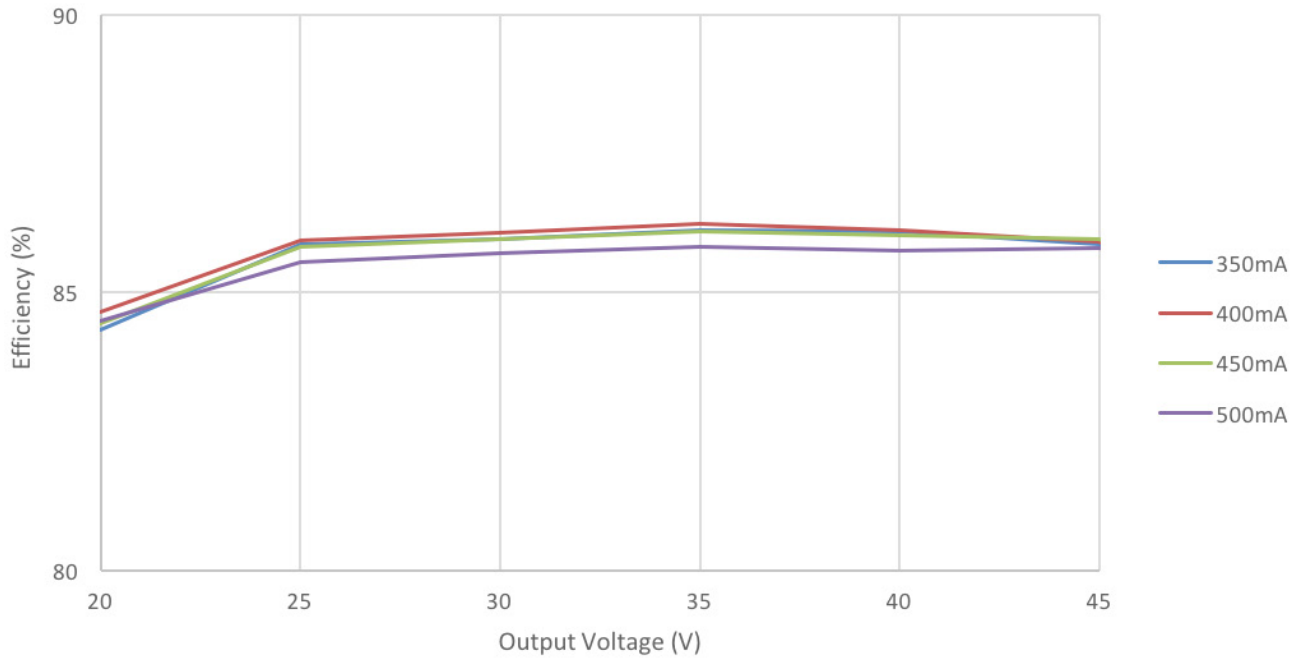

Efficiency Vs. Output Voltage at 277Vac

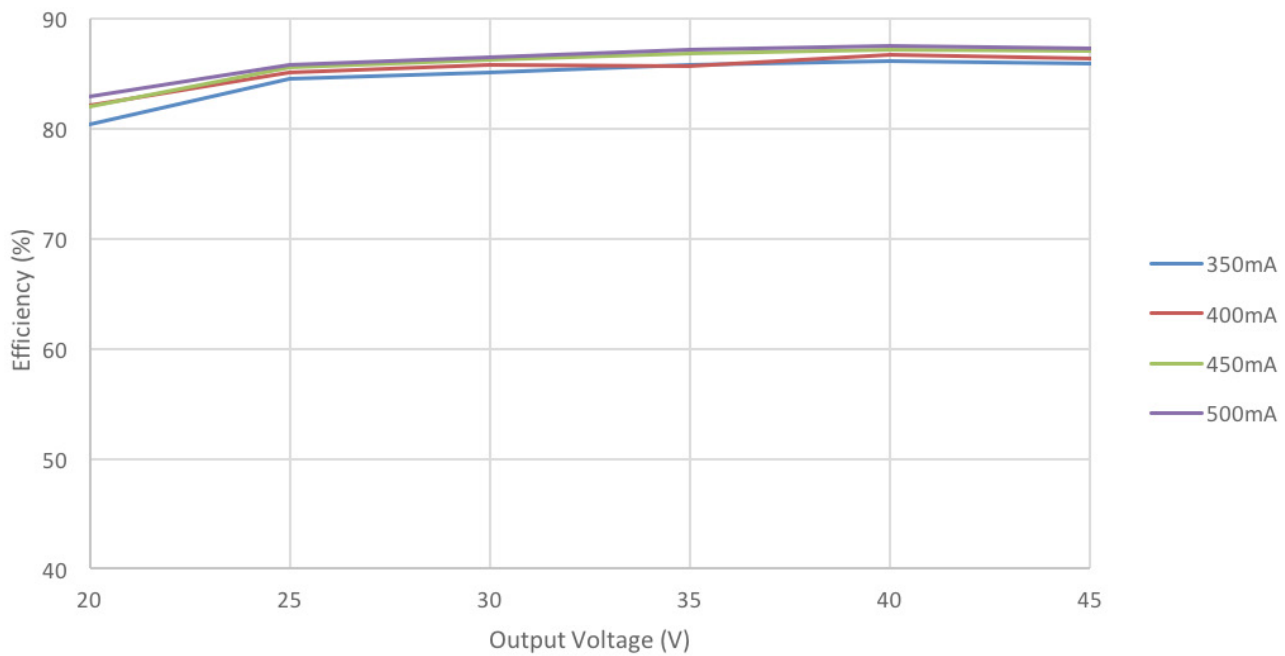

Xitanium 20W 0.35-0.5A 42V LE+TE INT

Performance Characteristics

Based on measurements on a typical sample at 70°C case. The accuracy of the measurements is within the tolerance of the measurement instruments.

Power Factor Vs. Output Power

Output Power Vs. PF_350mA

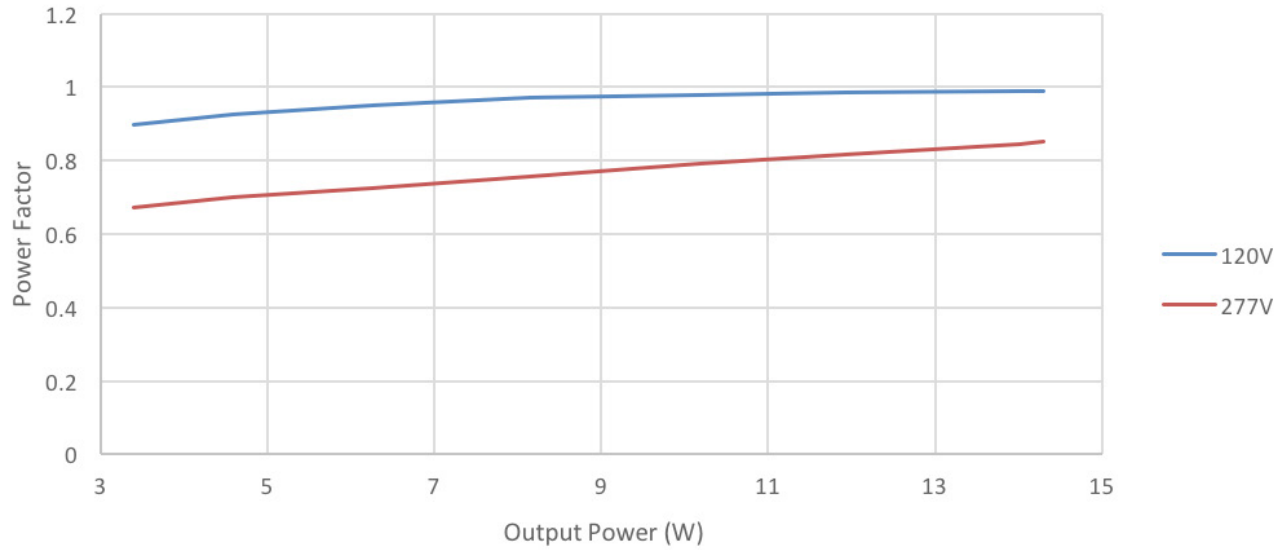

Output Power Vs. PF_500mA

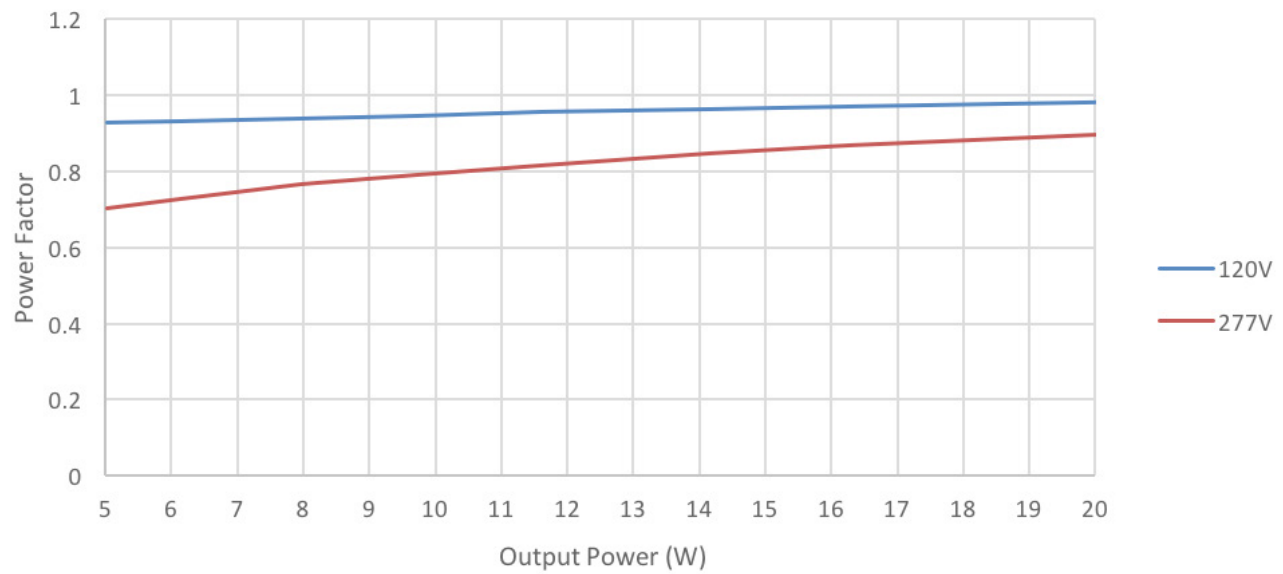

Xitanium 20W 0.35-0.5A 42V LE+TE INT

Performance Characteristics

Based on measurements on a typical sample at 70°C case. The accuracy of the measurements is within the tolerance of the measurement instruments.

Total Harmonic Distortion (THD) Vs. Output Power

Output Power Vs. THD_350mA

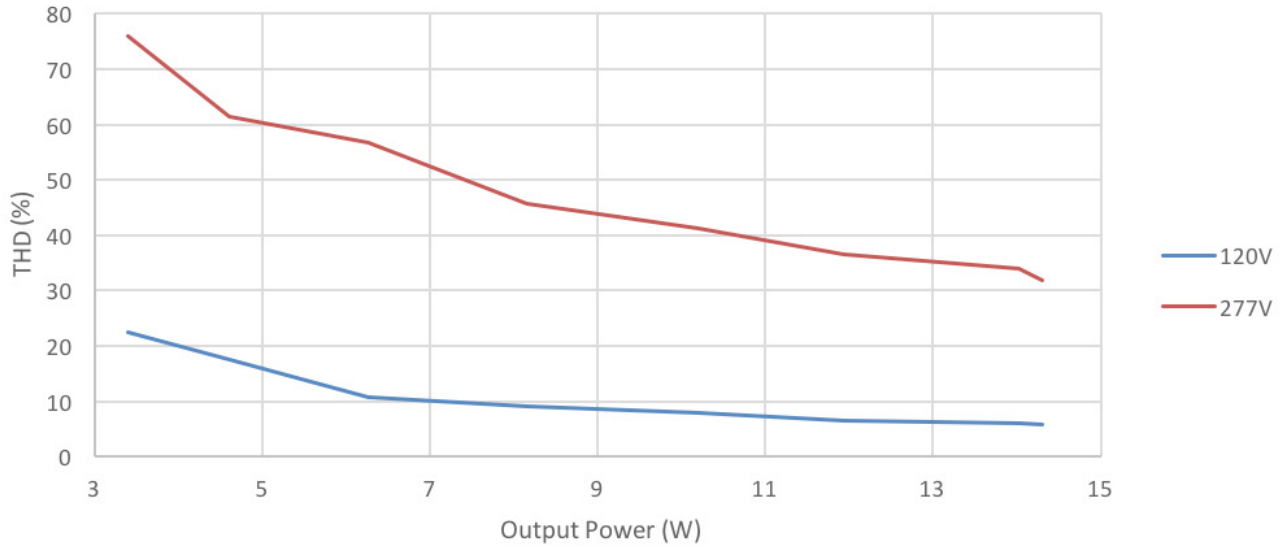

Output Power Vs. THD_500mA

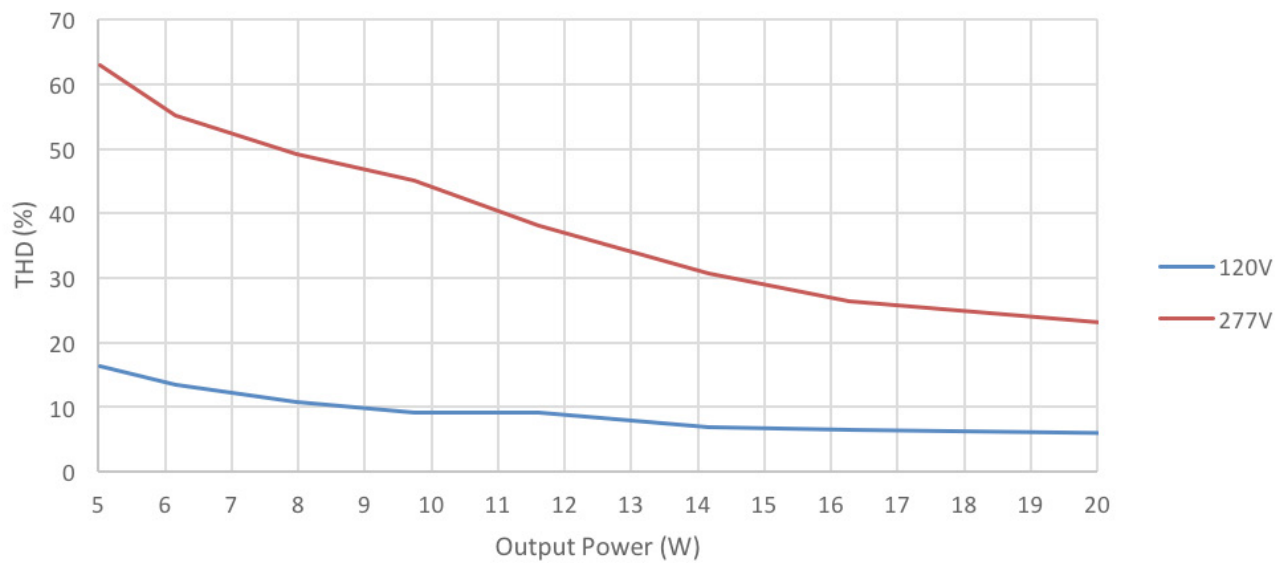

Xitanium 20W 0.35-0.5A 42V LE+TE INT

Inrush Current Info

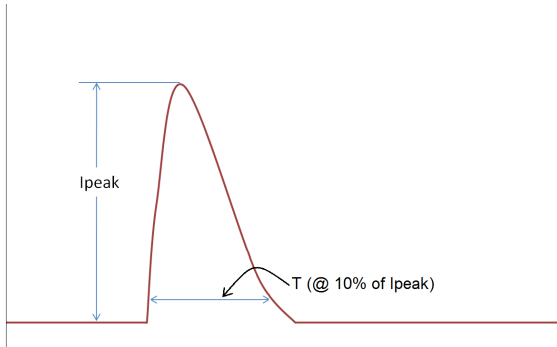

V _{in}	I _{peak}	T (@ 10% of I _{peak})
120 Vrms	1A	300μS
277 Vrms	2.3A	60μS

Inrush current is measured at peak of the corresponding line voltage. Source impedance per NEMA 410.

Lightning Surge Info

ANSI Surge Type	Differential Mode (L-N)
100kHz Ring Wave (w/t 30Ω)	2.5KV

Isolation

Isolation	Input	Output
Input	NA	2xU+1kV
Output	2xU+1kV	NA

U = Max working voltage

© 2016 Philips Lighting Holding B.V. All rights reserved.
 Philips reserves the right to make changes in specifications and/or to discontinue any product at any time without notice or obligation and will not be liable for any consequences resulting from the use of this publication.
philips.com/leddrivers



Philips Lighting North America Corporation
 10275 W. Higgins Road, Rosemont IL 60018
 Tel: 800-322-2086 Fax: 888-423-1882
 Customer/Technical Service: 800-372-3331
 OEM Support: 866-915-5886

Philips Lighting Canada Ltd.
 281 Hillmount Rd, Markham, ON, Canada L6C 2S3
 Tel. 800-668-9008