

BSKL02010300NX
BSKL02010301NX
BSKL02010302NX
BSKL02010303NX
BSKL02010304NX

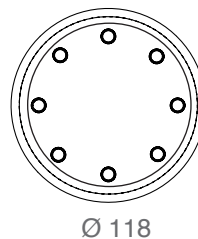

* not included.

* BOXSKILL1 (for outdoor)

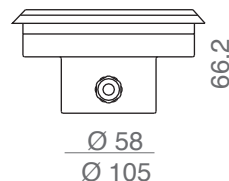
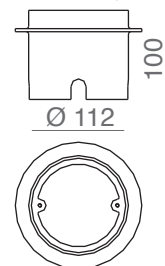

* BOXSKILL2 (for interior)

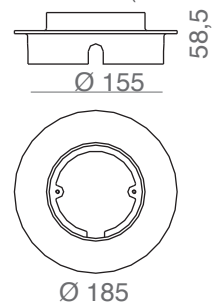

(mm)

		24V	1,8W		IP65/67		max 3000kg		max 35°C -20°C	
--	--	-----	------	--	---------	--	------------	--	-------------------	--

Finiture:
- corpo in alluminio, cover in acciaio cromato satinato (AISI 316)

Finishing:
- aluminum body, upper cover in sanded chromed stainless steel (AISI 316)

BSKL0201030_NX

This luminaire contains built-in LED lamps.

The lamps cannot be changed in the luminaire.

874/2012

General Information	Caractéristiques Générales	Allgemeine Informationen	Informazioni generali	
Material	Matériaux	Materialien	Materiali	aluminum / steel 316
Number of light sources	Nombre de Source(s)	Anzahl Lichtquellen	Numero sorgenti lum.	1xLED
Fixing system	Système de fixation	Befestigungssystem	Sistema di fissaggio	recessed
Driver included	Driver intégré	Treiber inklusive	Driver incluso	NO
Protection class IEC	Classe électrique	Schutzklasse	Classe di isolamento	III
IP code	IP	Schutzart	Grado IP	IP65/67
IK code	IK	Schlagfestigkeit (IK)	Grado IK	/
Optic type	Optique	Optik	Ottica	/
Cable	Câble	Kabel	Cavo	1 m
Dimmable	Gradable	Dimmbar	Dimmerabile	YES
European Community mark	Marquage CE	CE-Zeichen	Marchio comunità europea	CE
Lifetime to 80% luminous flux	Durée vie 80% flux lumineux	Lebensdauer bis 80% Lichtstrom	Durata funzion. (80% flusso)	30 000 h
Weight (kg)	Poids (kg)	Gewicht (kg)	Peso (Kg)	0,900 kg
Electrical	Caractéristiques Electriques	Elektrische Kenndaten	Corrente	
Input voltage	Tension d'alimentation	Netzspannung	Tensione di alimentazione	24 V
Initial performances	Performances initiales	Anfängliche Leistung	Performance iniziali	
Initial input power	Initial input power	Systemleistung	Potenza di sistema	1,8 W
Initial luminous flux	Initial luminous flux	Lichtstrom	Flusso luminoso iniziale	/
Initial LED luminaire efficacy	Initial LED luminaire efficacy	Effizienz	Efficienza luminosa iniziale	/
Init. Corr. Color Temperature	Init. Corr. Color Temperature	Farbtemperatur	Temperatura colore lampada	6000 K
CRI	IRC	CRI	CRI	> 90
Application conditions	Conditions d'application	Einsatzbedingungen	Condizioni applicazione	
Ambient temperature range	Température ambiante	Umgebungstemperatur	Temperatura ambiente	max. 35° C / min. -20° C

BSKL0201030_NX

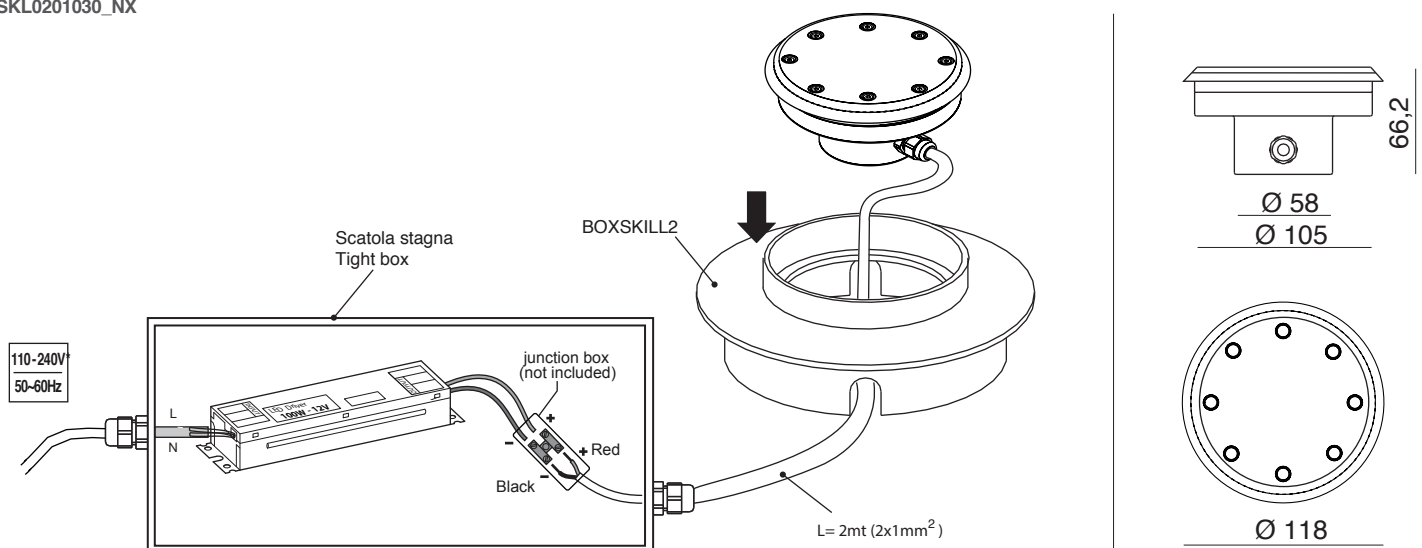

* BOXSKILL1 (for outdoor)

* BOXSKILL2 (for interior)

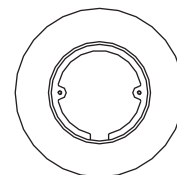
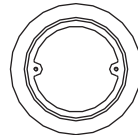
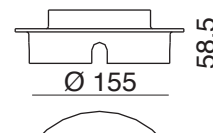
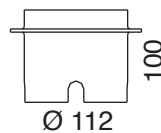

* not included.

(mm)

Esempio di collegamento (connessione in parallelo)/
Example of connection (parallel connection)

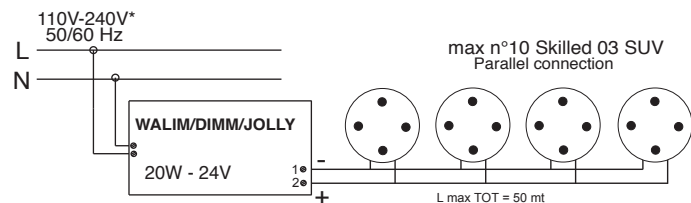

* Verificare la tensione di ingresso supportata dagli alimentatori / Verify the input tension supported from drivers

Alimentatori/ LED Drivers

Codice/Code non inclusi/not included	Caratteristiche/ Specifications	n. faretto/ n.spots
WALIM/DIMM/JOLLY	20W - 24V	4
WBOKVAR	Variatore/dimmer 1-10V	/



GENERALI / GENERALS

- L'installazione deve essere fatta da personale qualificato.
-Installation should be carried out by a suitable qualified installer.
- Non aprire il faretto
-Do not open the spot.
- In caso di guasti, previa autorizzazione al reso di ILTI Luce, il prodotto non dovrà essere aperto, il pressacavo non deve essere smontato e il cavo deve essere tagliato lasciandone almeno 10/15cm.
-In case of failure, upon a return authorization of ILTI LUCE, the product will not have to be opened, the cable gland must not be removed and the cable must be cut leaving at least 10/15cm
- Tutte le operazioni di cablaggio e manutenzione vanno eseguite con l'interruttore generale in posizione OFF.
-All wiring and maintenance must be performed with the main switch in the OFF position.



MANUTENZIONE/
MAINTENANCE

- Togliere tensione prima di eseguire operazioni di manutenzione.
-Disconnect main voltage before maintenance operation.
- Pulire periodicamente la superficie frontale del faretto. Non utilizzare detersivi a base acida.
-Periodically clean the frontal part of the spot. Do not use acid substances.

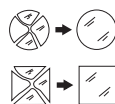

- Per un corretto funzionamento, l'apparecchio necessita di relativo vetro di protezione integro.
-For a proper operation, the fitting requires its protective undamaged glass.

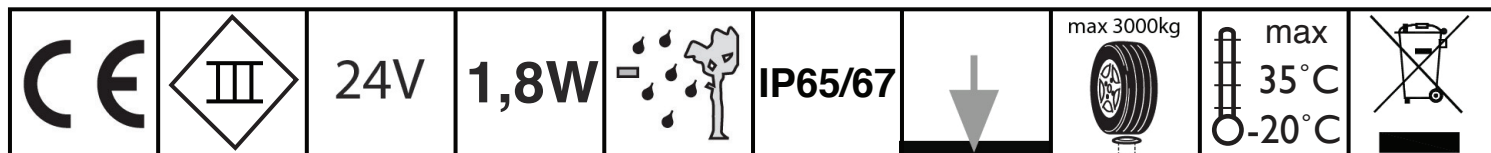

si consiglia la conservazione delle seguenti istruzioni - we suggest you to keep this copy for your files

IP65-67 application

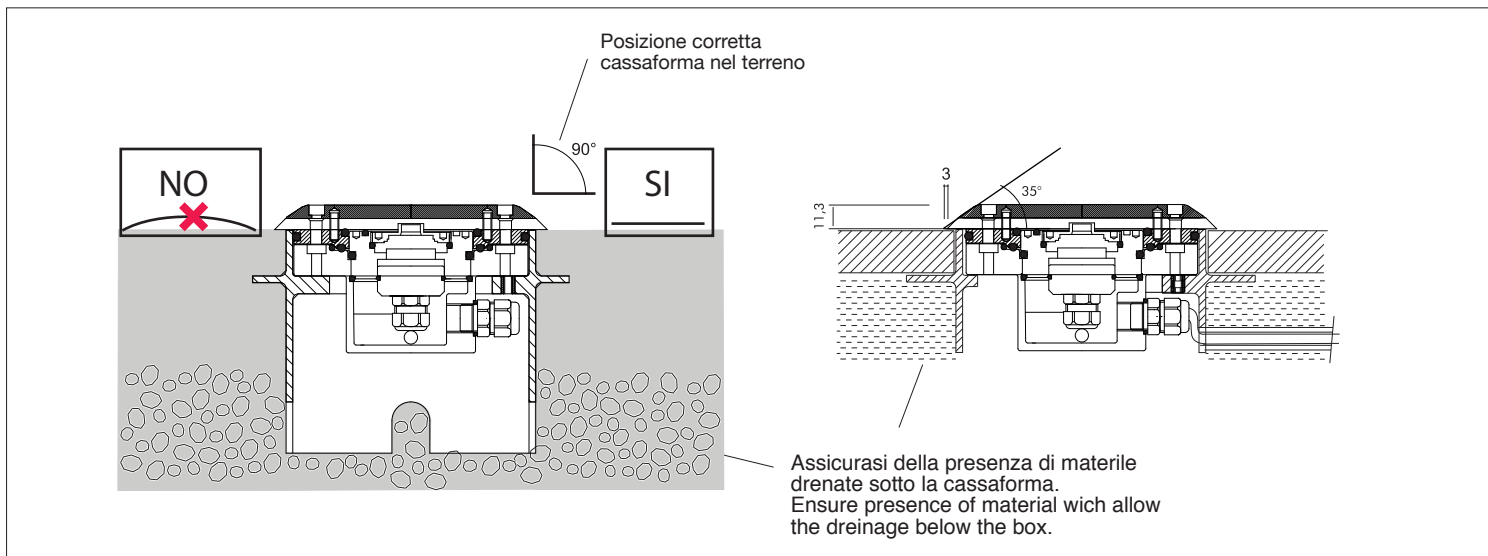

1- Posizionare con la malta il pozzetto nella zona interessata facendo uscire il tubo per il passaggio del cavo elettrico al suo interno.
Place the pot with the mortar extracting the tube out for the passage of electrical cable inside.

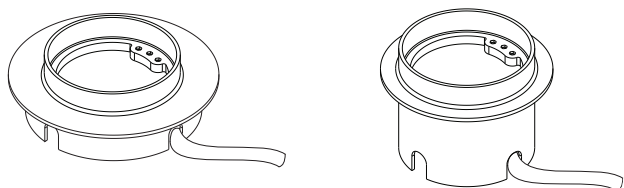

2- Svitare le viti 1 e 2 e sollevare la parte superiore del faretto.
Unscrew the screws n° 1 and 2 and raise the top of the spot.

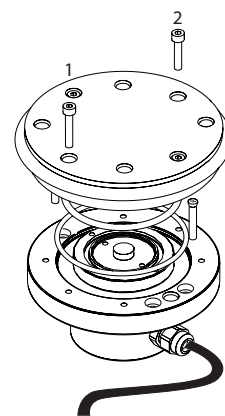

3- Inserire la base del faretto(1) agevolando l'ingresso del cavo nella cassaforma.
Insert the base of the spot (1) and the cable in the recessed box.

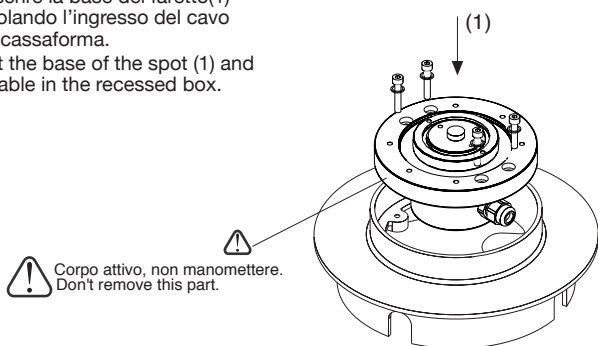

4- Riposizionare gli elementi nell'ordine corretto facendo attenzione alla corretta disposizione degli O.R.
IMPORTANTE: stringere le viti ed assicurarsi che il faretto sia chiuso in maniera corretta.
Put all elements bck following to the correct sequence and install correctly O.R.
WARNING: properly tighten/seal the top portion of the fixture.

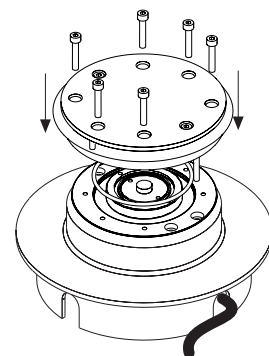

**CABLAGGIO/
WIRING**

⚠️

- Effettuare il cablaggio usando un sistema che garantisca almeno il grado IP del faretto.
- Make the wiring using a system that guarantees at least the IP grade of the spot.
- Dare tensione all'impianto solo dopo aver collegato tutti i LED all'alimentatore.
- Connect the fitting to the power supply only after connecting all LED to the driver.

**SMALTIMENTO/
DISPOSAL**

⚠️

Secondo la direttiva comunitaria WEEE (Waste Electrical and Electronic Equipment) l'apparecchio non può essere smaltito con i rifiuti indifferenziati. Deve essere portato nelle strutture locali per lo smaltimento ed il riciclaggio dei prodotti elettronici.

In accordance with EU Directive WEEE (Waste Electrical and Electronic Equipment), luminaires must not be disposed of with other household waste. At the end of their life, luminaires must be taken to the appropriate local facility available for the disposal or recycling of electronic products.

si consiglia la conservazione delle seguenti istruzioni - we suggest you to keep this copy for your files

tabella di riepilogo prodotti/ product overview table

	colore/ colour	tipo/ type	potenza/ power	fascio ottico/ optic beam	ottica/ optic	tipo di LED/ LED type	materiale/ material	finitura/ finishing	fissaggio/ fixation	IP/ IP
BSKL02010300NX	cool white	esterni/ outdoor	1,8W	schermo trasparente/ transparent screen	fissa/ fixed	alta emissione/ high emission	acciaio e alluminio/ stainless steel and aluminum	grigio/ grey	con cassaforma/ with box	65/67