

Lightstrip Plus

71901/**/PH

71903/**/PH



Gebruiksaanwijzing

Notice d'emploi

Benutzerhandbuch

User manual

Manual de usuario



PHILIPS

Incl.

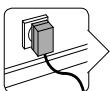
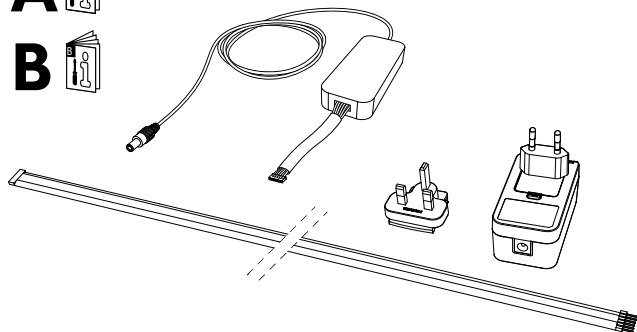



Max. 10m



71901/**/PH
71903/**/PH

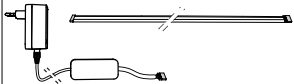

71902/**/PH
71904/**/PH



UK

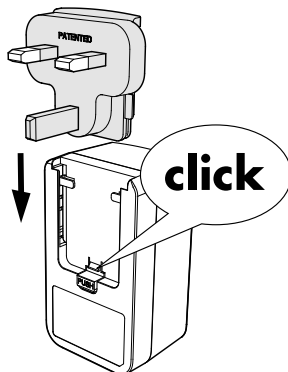
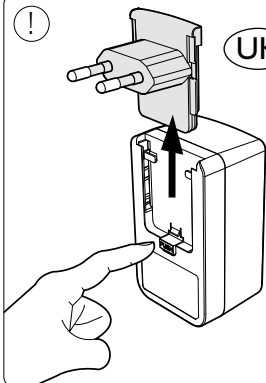

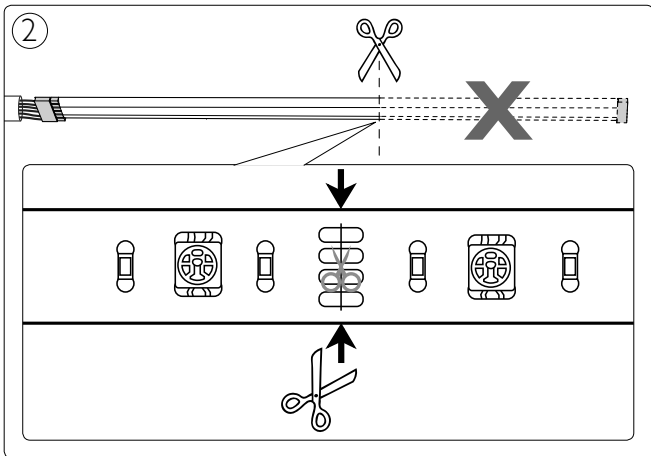
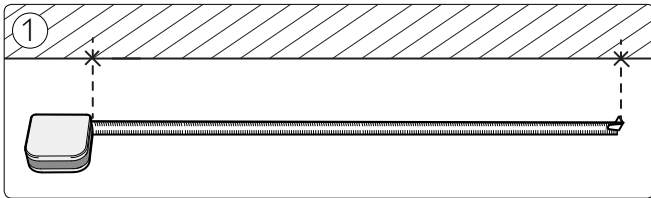
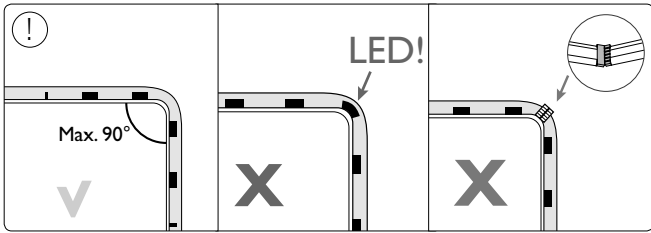

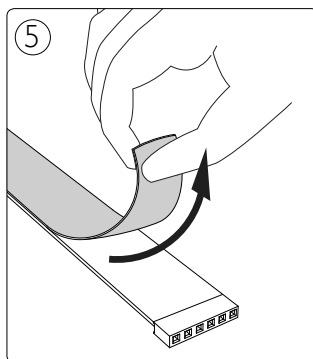
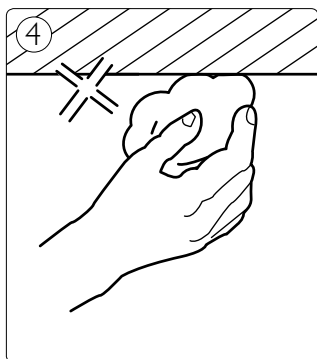
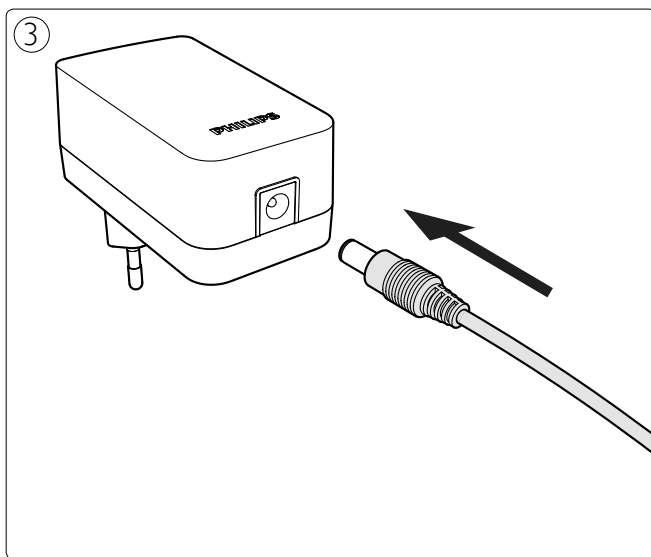

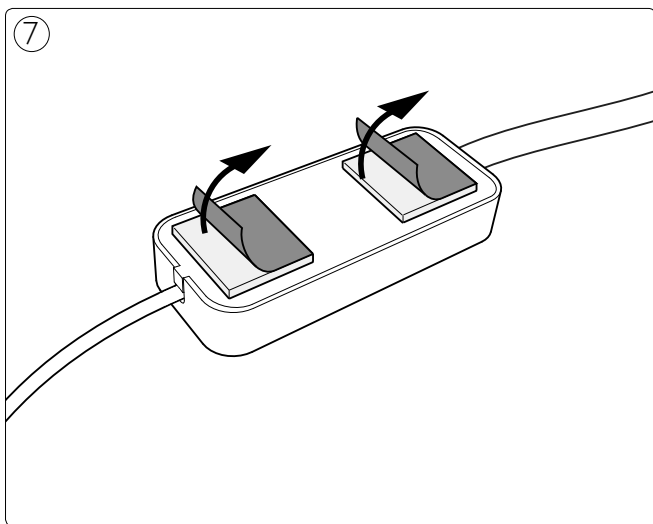
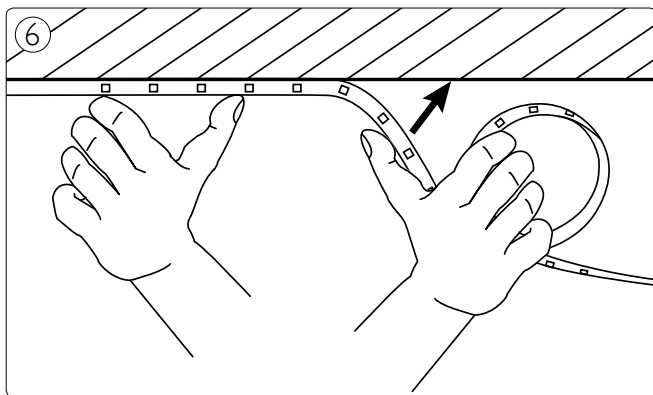

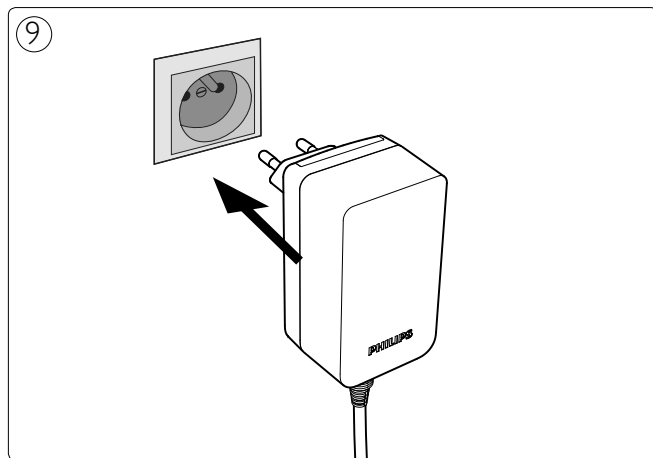
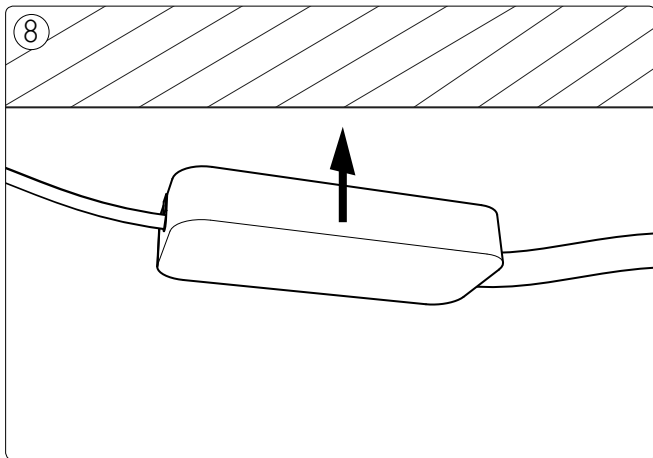

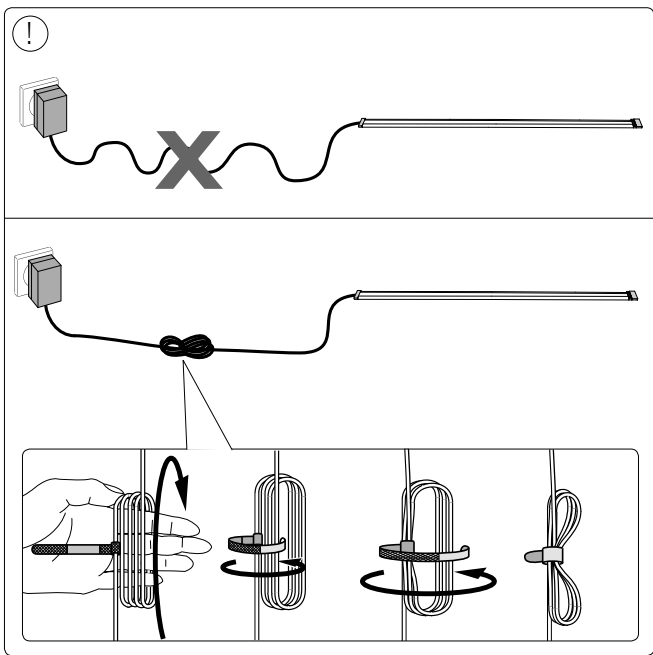

EN Connect to hue bridge:**Control with smart devices**

- Switch on Hue Lightstrip Plus
- Plug in the Hue bridge and connect it to your wi-fi router
- Download and start the latest Philips Hue app, and follow the instructions on your smart device.
- Visit meethue.com to discover more hue products and popular apps.

DE Anschluss an die hue-Bridge:**Steuerung über Smart-Geräte**

- Hue Lightstrip Plus einschalten
- Stecken Sie die hue-Bridge ein, und stellen Sie eine Verbindung mit dem WiFi-Router her.
- Laden Sie die neuste Philips Hue-App herunter; starten Sie sie, und folgen Sie den Anweisungen auf Ihrem Smart-Gerät.
- Besuchen Sie meethue.com, um mehr hue- Produkte und beliebte Apps zu entdecken.

FR Connexion au pont hue:**Commande depuis un smartphone/ une tablette**

- Branchement de Hue Lightstrip Plus
- Branchez le pont hue et connectez-le à votre routeur Wi-Fi
- Téléchargez et lancez la dernière application Philips hue, puis suivez les instructions sur votre smartphone/ tablette.
- Rendez-vous sur meethue.com pour découvrir plus de produits et d'applications populaires pour hue.

NL Aansluiten op hue bridge:**Bediening met smart devices**

- Schakel Hue Lightstrip Plus in
- Sluit de hue bridge aan op een stopcontact en uw Wi-Firouter

- Download en start de nieuwste Philips Hue-app en volg de instructies op uw smart device.

- Ga naar meethue.com voor meer Hue producten en populaire apps.

ES Conexión al puente hue bridge:**Control con dispositivos inteligentes**

- Activa Hue Lightstrip Plus
- Enchufa el puente hue bridge y conéctalo a tu router Wi-Fi
- Descarga e inicia la versión más reciente de la aplicación Philips hue y sigue las instrucciones en el dispositivo inteligente.
- Visita meethue.com para descubrir más aplicaciones y productos hue.

IT Collegamento al bridge hue:**Comando con i dispositivi smart**

- Accensione di Hue Lightstrip Plus
- Collega il ponte hue e connettiti al router Wi-Fi
- Scarica e avvia la app Philips hue, quindi segui le istruzioni sul tuo dispositivo smart.
- Visita meethue.com per scoprire altri prodotti hue e tutte le app più richieste.

NO Koble til hue-bridg: Kontroll med smartenheter

- Slå på Hue Lightstrip Plus
- Koble til hue-bridgen, og koble den til WiFiruteren
- Last ned og start den nyeste Philips hue-appen, og følg instruksjonene på smartenheten din.
- Gå til meethue.com for å finne flere hueprodukter og populære apper.

FI Yhdistäminen hue bridge -sillalla:**Ohjauksen älylaitteilla**

- Käynnistä Hue Lightstrip Plus
- Kytke hue bridge -silta ja liitä se Wi-

Fireittimeen

- Lataa ja käynnistä uusin Philips hue -sovellus ja noudata älylaitteen ohjeita.
- Saat lisätietoja hue-tuotteista ja suosituista sovelluksista osoitteesta meethue.com.

DA Tilslut til hue-bro:

Styring via smart-enheder

- Tænd for Hue Lightstrip Plus
- Slut hue-broen til lysnettet, og slut den til din wi-fi-router
- Download og start den nyeste Philips hueapp, og følg instruktionerne på din smartenhed.
- Gå til meethue.com for at finde flere hueprodukter og populære apps.

TR hue köprüsü:

Akıllı cihazlarla kontrol

- Hue Lightstrip Plus'yu açın
- hue köprüsünü takın ve wi-fi yönlendiricinize bağlayın
- En güncel Philips hue uygulamasını indirin ve başlatın. Ardından akıllı cihazınızda talimatları izleyin.
- Daha fazla hue ürünü ve popüler uygulamalar için meethue.com adresini ziyaret edin.

PL Podłączenie do mostka hue:

Sterowanie za pomocą urządzeń przenośnych

- Włącz lampę Hue Lightstrip Plus
- Podłącz mostek hue do gniazdka i routera Wi-Fi
- Pobierz i uruchom najnowszą aplikację Philips hue, a następnie postępuj zgodnie z instrukcjami wyświetlanymi w urządzeniu przenośnym.
- Odwiedź stronę meethue.com, aby odkryć więcej produktów hue i popularnych aplikacji.

SV Ansluta till hue Bridge:

Styr via smartenheter

- Slå på Hue Lightstrip Plus
- Koppla in hue Bridge och anslut till en Wi-Fi-router
- Ladda ned och starta Philips senaste hueapp. Följ därefter instruktionerna som anges på smartenheten.
- Gå till meethue.com så kan du läsa mer om de olika hue-produkterna och populära appar.

CS Připojení můstku hue:

Ovládání prostřednictvím chytrých zařízení

- Zapněte systém Hue Lightstrip Plus.
- Zapojte můstek hue a připojte jej k routeru Wi-Fi.
- Stáhněte a spusťte nejnovější aplikaci Philips hue a postupujte podle pokynů na vašem chytrém zařízení.
- Navštivte stránku meethue.com a zjistěte více o výrobcích hue a oblíbených aplikacích.

HU Csatlakozás a hue bridge-hez:

Vezérlés intelligens eszközzel

- A Hue Lightstrip Plus bekapcsolása
- Dugja be a hue bridge-et a fali aljzatba és csatlakoztassa a Wi-Fi útvalasztóhoz
- Töltse le és indítsa el a legújabb Philips hue alkalmazást, majd kövesse intelligens eszközén az utasításokat.
- Látogasson el a meethue.com oldalra, és fedezzen fel még több hue terméket és népszerű alkalmazást.

www.meethue.com/support



Philips Lighting Contact Centre
Int. Business Reply Service
I.B.R.S. / C.C.R.I. Numéro 10461
5600 VB Eindhoven
Pays-Bas / The Netherlands

www.philips.com/homelighting
 +800 7445 4775

4404.017.01401
Last update: 28/05/2015