



PHILIPS

Luminous patterns

Signature lighting accents
for any interior



Bring spaces to life

with color, texture and dynamic light effects

Luminous patterns is perfect for architects and designers who want to make a unique statement using color, texture, light, pattern, and movement. The bespoke panels allow you to fuse light to surfaces that would be otherwise unremarkable. And with customizable light effects at your command, you can stir emotions, create a striking focal piece, or alter the ambience. The choice is yours.

Creating unique spaces

Welcome visitors to your venue with energizing light that makes an instant impression.

Free your creativity

Create memorable guest experiences with dazzling illumination that adds charm and elegance.

Catch the attention

Build eye-catching retail displays in-stores and shopping centers, grabbing the attention of shoppers.

Reinforce your brand

Direct guests with customized signage that matches your brand design and creates signature ambience.

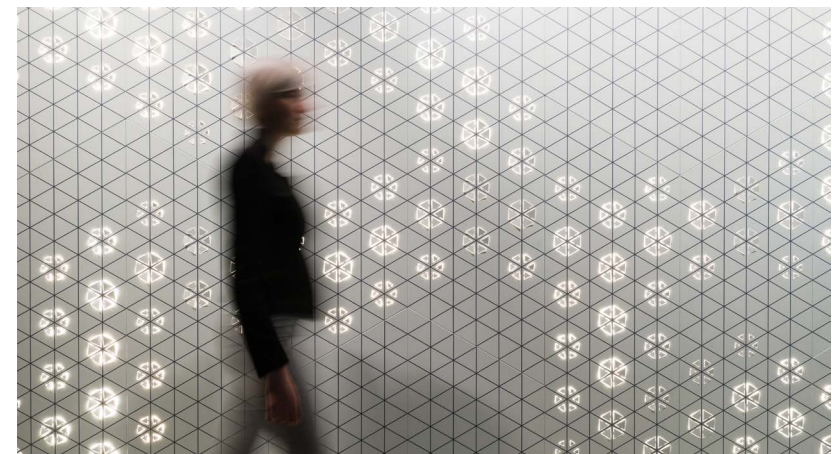

From a few statement panels to complete surface solutions, Luminous patterns offers you the design freedom to create the right signature configuration for any interior.



Application areas of Luminous patterns

Imagine creating a breathtaking surface that sparkles with a hundred light points or radiates with a candle-like golden glow. A surface that blends color, texture and dynamic light effects in one ambient experience. Now you can recreate these effects with Luminous patterns. We take the versatile power of LEDs and house it in a beautiful and bespoke panel that is ideal for hospitality and retail interiors. Impossible to forget, Luminous patterns puts a world of design possibilities in your hands. So you can express emotions, create striking accents and bring spaces to life.



Hospitality

Create an iconic light display that will enchant and mesmerize everywhere from the entrance hall to the penthouse suite. Blend tactile surfaces with an original sense of brilliance. Or choose distinctive colors, textures and effects to reflect a unique brand style.

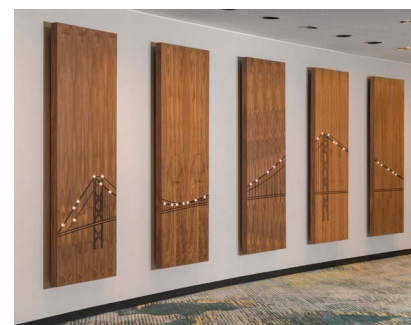

Offices

Turn conference rooms from boring to inspirational. With Luminous patterns you can transform office lighting into a dynamic experience that stimulates, refreshes and excites.



Retail

Bring retail brands to life in new and exciting ways that connect with shoppers on the deepest level. Luminous patterns can channel your ideas to express a brand's style beautifully, giving a store exceptional stand out and making merchandise impossible to resist.



Our product range

You can design your own custom Luminous patterns wall. Use the different light effects, printing technology, colors and textures to create a completely bespoke feature. Our designers can help you with this. Inspired by this design freedom, we have made a selection of walls. The walls are designed with different light effects and finishes and can be used as an inspiration or of course delivered as a complete design. Our selection can also be customized with additional options including different colors, light effect programming and different size. The choice is yours.



Our selection

Customize our surface designs with different options.



Custom designs

A new idea? Our flexible design system enables creating unique installations from scratch.

Discover our selection? Contact us at luminouspatterns@philips.com

Luminous patterns

Product system

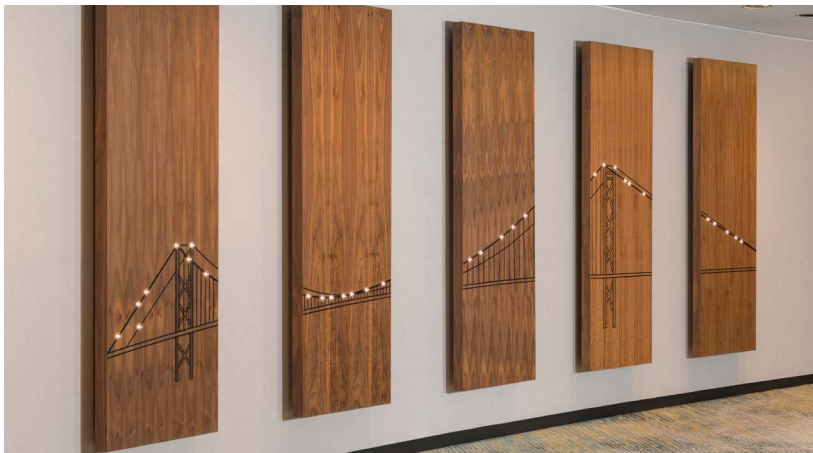
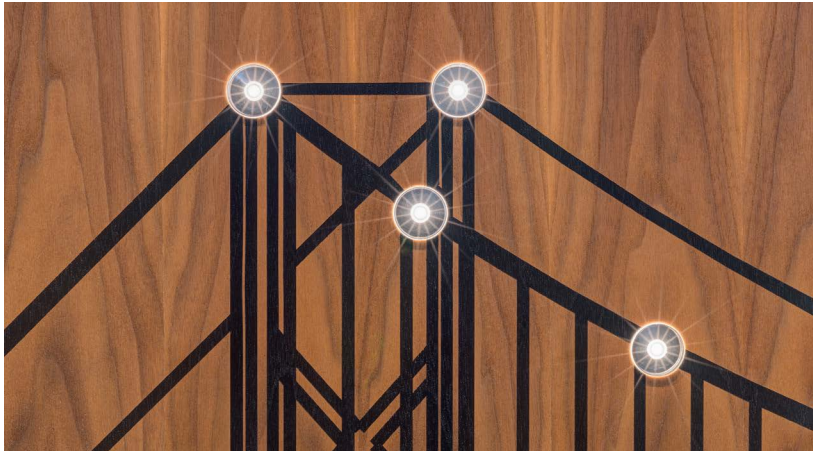

Down to the last detail - our custom light sources are designed to work from close and far.

Unique design system

Luminous patterns are made with custom LEDs, arranged to form light patterns on a durable sheet metal panel. The size, shape and light layout are hand-made to your specifications, complete with paint finishes and graphic overlays that fit your aesthetic vision.

Beautiful graphic panels

Our panels come both in standard and custom sizes, shapes and layouts and can be arranged in numerous ways to bring each space alive. From complete wall surfaces to scattered individual panels across a wall. The options are endless.

Easy installation and control

Your panel is built-to-order and then delivered to you ready for easy surface mounting. Once the panel is in place, you control settings and programs using a digital lighting system. Each light point can be controlled individually via customized programs, giving you vast opportunities for dynamic illumination.



Tailored to size

Every panel is manufactured according to your needs, up to one-millimeter precision. Besides rectangular panels, trapezoidal geometries are also available.



Perfect match

Do not settle for a second choice in surface materials. Choose from our dozens of surface coating options to ensure your panels fit perfectly in the spaces you craft.

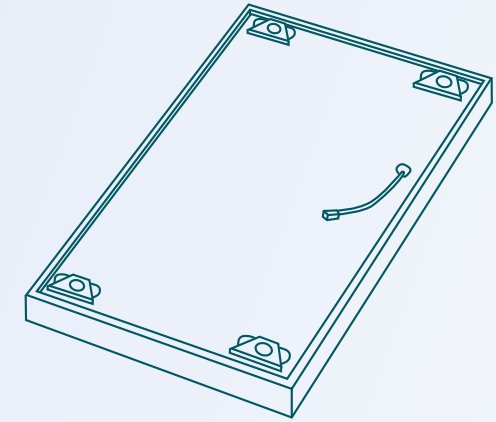

The panels are mounted on a surface with a secure bracket system, which allows both ceiling and wall applications.



Bring your panels alive

All our light effects are available in both white and full RGB.

In order to create mesmerizing light shows, the lights are individually controllable via a selection of pre-programmed light shows. Switching a light program is as easy as pushing a button on the control unit.



Custom printing

Our UV-cured printing technique makes it possible to integrate lighting to any design you wish. Combining personalized interior surfaces with light elements has never been this easy.

Printing is available on the majority of the available coating options.



Sparking creativity: our customizable light effects

Drawing from our extensive knowledge of interior lighting, we have created Luminous patterns with a choice of customizable light effects. Pick from five unique light effects to create the design style you prefer.



Round sparkling

Capture the ambience of candlelight with these sparkling spherical light sources. They bring warm, brilliant light and a touch of romance to any environment.

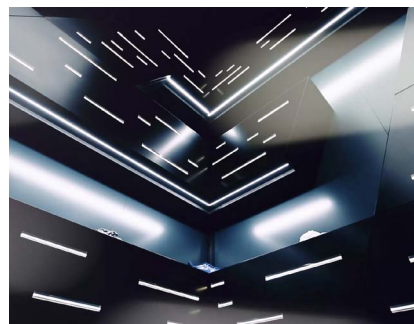

Linear sparkling

Create a dynamic sense of motion with these sleek linear lights. Their bright, artful illumination can fade from one end to the other, giving the appearance of light streaking across a surface.



Your design, our building blocks? Creating customized designs is possible with the help of our design rules. Contact our design team to find out more.

Contact us:
luminouspatterns@philips.com

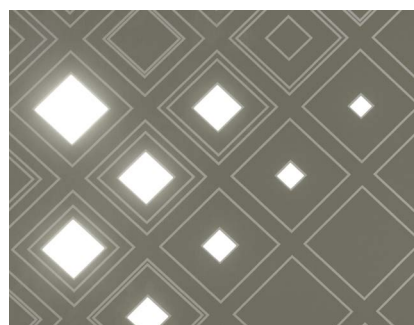

2D graphic

Harness the decorative power of light and shape. 2D graphics are laser-cut so you can infuse a graphic pattern with a gentle luminosity.



3D graphic

Transform your surface into a work of art. 3D graphics are laser-cut and bent into a variety of shapes, creating delightful patterns of light with shadow and depth.

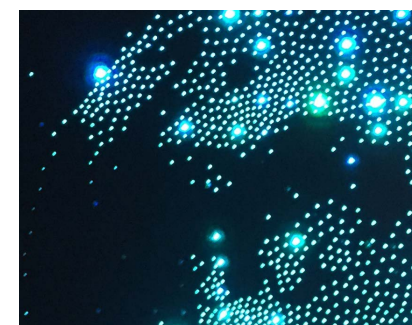

Brilliant graphic

The sparkling LEDs create a shimmering crystalline glow that appears to move – a truly captivating optical illusion adding a touch of glamour in your interior.



Small informational text panel on the white wall to the right of the wood wall.



Perfect match for your interior

Luminous patterns understands the complexity of your interiors. For this reason, we offer a wide range of powder coatings and architectural foils to fit any interior.

Your design can blend seamlessly into its environment, or contrast its surroundings elegantly. With a choice of powder coatings and architectural foils that resemble materials like wood, leather or metal, there are countless ways to customize your fixture's finish.



Specific wishes? Besides the featured coating collections, our panels are available in the full RAL palette. Printing on any color is possible in the full Pantone color space.

Selection of our architectural foils



PS-090

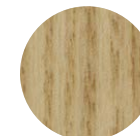

WG-1143



FW-327

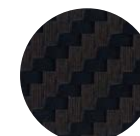

CA-421



PA-045

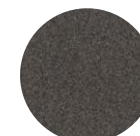

PA-389



FW-336

Selection of our powdercoatings



DBR201

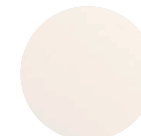

YW263I



DBR206



Y2317F



DBR210



YW385I



YW266F

Discover our full range of finishing options? Contact us at luminouspatterns@philips.com

Technical specifications

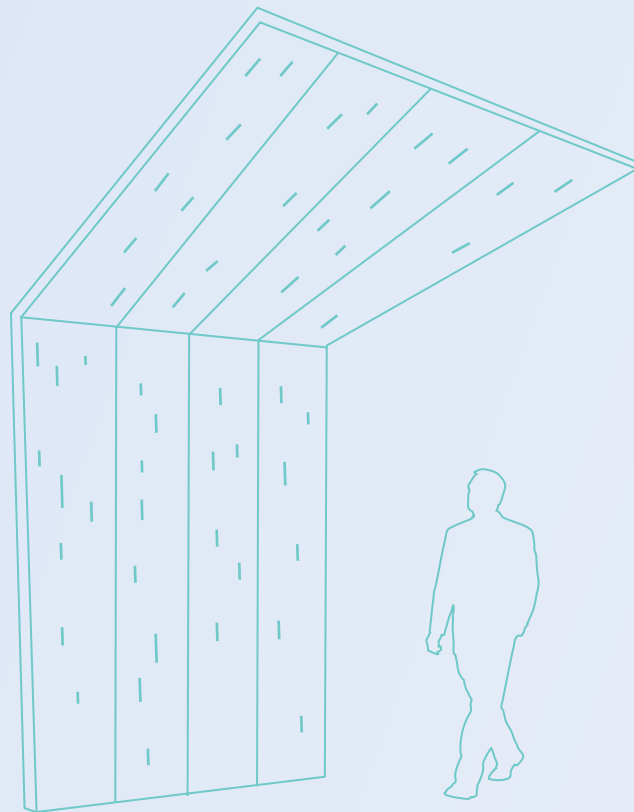

Finish	AkzoNobel powdercoatings Optional: 3M DI-NOC architectural foil Optional: UV-cured print
--------	--

Dimensions (panel)	Min. 400 x 400 mm Max. 600 x 1800 mm
--------------------	---

Number of panels in a system	Unlimited
------------------------------	-----------

Thickness (panel)	45 mm
-------------------	-------

Mounting	Walls and ceilings; any orientation possible Bracket system delivered together with the panels
----------	---

Usage environment	Indoor application only (IP40)
-------------------	--------------------------------

Operating temperature	15-40 °C 59-104 °F
-----------------------	-----------------------

Relative humidity	Max. 95% non-condensing
-------------------	-------------------------

Light color options	White LED RGB
---------------------	------------------

Light effects	Round sparkling Linear sparkling 2D graphic	3D graphic Brilliant graphic
---------------	---	---------------------------------

Input voltage	7.5 V/24 V depending on light style
---------------	-------------------------------------

Certifications	CE UL/cUL pending FCC pending
----------------	-------------------------------------

Warranty	5 years
----------	---------

Contact us

Find out more? Visit our showrooms in Europe, North America and Asia or check our websites.

www.luminouspatterns.com
www.luminouspatternsdesign.com (beta)



Luminous patterns showroom
Eindhoven, The Netherlands

For questions, contact our team at luminouspatterns@philips.com

