

Intelligent lights – spots

VLZ Profile

The Philips Vari-Lite VLZ Profile is a dedicated profile luminaire utilizing the latest high output white LED sources to produce a staggering 24,000 lumens projected from a 180mm front lens.

The familiar CMY-CTO color system creates stunning, seamless mixed colors. The dual fixed color wheel with linear control gives access to Vari-Lite colors and split color combinations. Color shake and color wheel spin control have also been added to the mix.

Both mid-air and high quality projection of images is achieved by the 2 gobo wheels loaded with Vari-Lite exclusive gobo patterns. An additional continuously indexing or rotatable animation wheel further enhances the projected effect. Fitted with both an iris and a 4-blade framing system, giving the operator full beam-shaping control. Hard to soft edge focusing is achieved via the 16-bit focus control channel and focus zoom. racking can be selected remotely via the lighting console. The beam softness can be controlled via the 3-way frost control.

The combination of the color and beam control will make this the go-to professional moving profile luminaire

Product data



Feature and benefits

- 24,000 lumens.
- 8–50° zoom.
- High quality image projection via 140mm (5.5in) front lens.
- High output white light LED light source engine to maintain constant high output light levels.
- Wide zoom range.
- 16-bit dimmer control with 4 sectable curves.
- Color mixing system CMY + CTO color control.
- 6 fixed color - 1 color wheels 6 + open with color shake and wheel spin functions.
- 1 fully rotating and indexing gobo wheel 7 + open.
- 1 fixed rotating gobo wheel 7 + open loaded with interchangeable glass mid-air effect and breakup gobos.
- 3-way frost control.
- 3 facet prism.
- Iris for beam size reduction.
- Fast, accurate and repeatable movement on all functions.
- Animation wheel with continuous indexable /rotation.
- Framing shutter system 4 blade with independent control and frame rotation ±50 degree either side of center.

Source	LED
Lamp cap	N/A
Wattage	620W
Lumen output (max.)	24,000
Color temperature	8000K source, variable CTO
CRI	>70
Beam angle	8–50°
Pan / tilt	540° / 270°
Controls	DMX512-A / RDM, Art-Net™
DMX channels	61
Color system	CMY, Variable CTO 1 x fixed color wheels 6 + open
Gobo / effects	1 x rotating / indexing wheel 7 + open, 1 x fixed gobo wheel 7 + open
Independent rotating prism	3 facet round
Independent frost	3 way frost system
Dimmer / strobe	Electronic 16-bit
Framing shutters / beam shaping	Yes
Iris	Yes
Color claibration	N/A
Accessories	–
Operating voltage	100–240VAC, 50/60Hz
IP rating	IP20
Operating temperature	–10–45°C
Construction	Metal frame, engineering plastic covers
Finish	Black
Dimensions H x W x L	458 x 316 x 796mm (18.03 x 12.44 x 31.34in)
Hanging centers	600mm (23.62in)
Weight	42.4kg (93.5lb)
Warranty	2 years

Product data

Philips Vari-Lite VLZ Profile

	Wattage	Beam	Overall dimensions W x H x D	Weight	Order Code
Philips Vari-Lite VLZ automated LED Profile, (framing shutters) with input power powerCON connector AC100-240V	620W	8-50°	458 x 316 x 796mm (18.03 x 12.44 x 31.34")	42.4kg (93.5lb)	26-105-0002-00
Luminaire programing kit					PEGASUS

Dimensional drawing

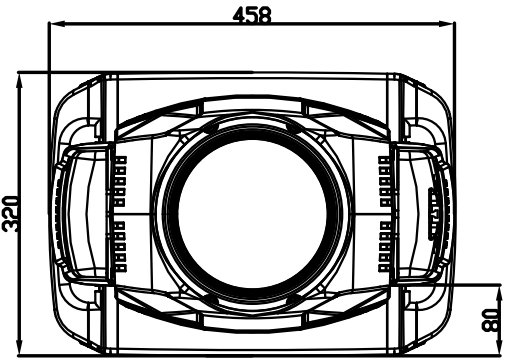
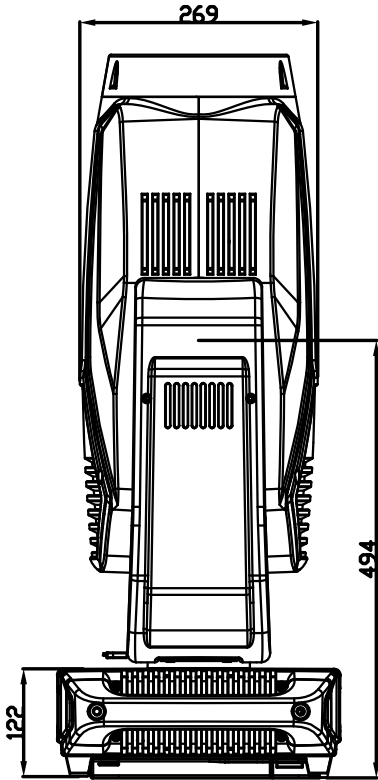
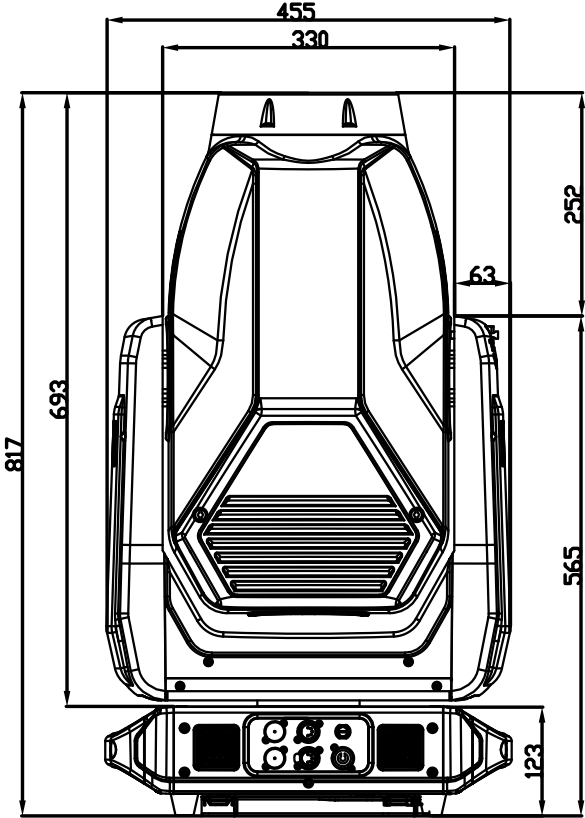
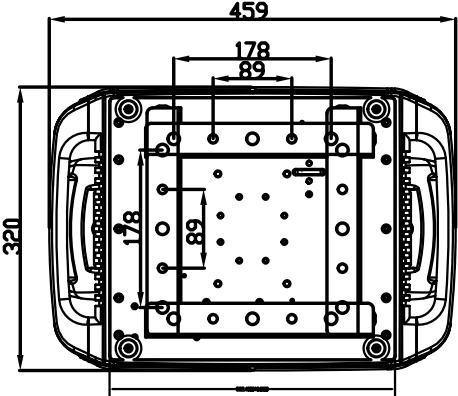



© Philips Lighting Holding B.V. 2017. All rights reserved. Philips reserves the right to make changes in specification and/or to discontinue any product at any time without notice or obligation and will not be liable for any consequences resulting from the use of this publication.

www.philips.com/vari-lite

04/2017

Data subject to change. All measurements quoted primarily in millimeters.