

PHILIPS

LED tube



Loose contact or **absolute precision?**

Real professionals count on **Philips LED tubes**



NEW **T8** and
T5 options

**REAL
PROs**
**REAL
QUALITY**

Bright easy-to-fit LED tubes **that last and last**

LED tubes only use around half the energy of fluorescent alternatives, so the instant energy savings from a lamp replacement can pay for the new tubes within a couple months. From 24/7 usage downwards, it's the installation costs and tube lifetimes that overwhelmingly set actual repayment times.

Our portfolio of Philips LED tubes covers the widest range of applications. It now includes the MASTER LEDtube T8 Ultra Efficiency range for the world's best-in-class lumen performance up to 172 lm/W and a T8 tube specially for food display. It also includes new options in the MASTER LEDtube T5 range, including Ultra Efficiency to cover even more applications. The new generation of CorePro LED tubes T8 feature a shorter aluminium end cap and improved performance.

Fast installation, long reliable life

Philips LED tubes offer 100% safe and hassle-free installation with a simple lamp-for-lamp replacement. Our EM/mains and InstantFit HF tubes fit straight into existing luminaires. Our LED range has the widest ballast compatibility* in the market (600, 1200 and 1500mm version lists are regularly updated).

The guaranteed lifetime outshines fluorescents with more than double the lifetime to halve maintenance costs. When you include the price of the tube, installation and maintenance they pay for themselves within a few months for permanently lit sockets.

High quality professional lamps

Our LED tubes won't flicker or cause glare. They switch on instantly with excellent color consistency and uniform visual appearance. We can also offer dimming functionality for defined tube/ballast combinations. And with rotating end caps it's easy to direct the light where it is needed. All in all, a new generation of attractive energy-saving alternatives to fluorescent tubes.

* To find out more about ballast compatibility go to www.philips.com/ledtube



An **LED light** for every need, from the **world leader** in lighting

MASTER LEDtube

Ultra Efficiency range

The MASTER LEDtube Ultra Efficiency, available in T5 and T8, has been designed for the world's best-in-class lumen performance of up to 172 l/W. With an ultra-long lifetime of 60,000 hours, these lamps offer a high lumen output along with the best Total Cost of Ownership over lifetime. Ideal for ultra-demanding applications with very long burning hour periods, such as industrial and healthcare applications, they're compatible with EM ballasts or mains power.

Universal T8 range

The new Philips MASTER LEDtube Universal T8 range brings a new degree of simplicity to retrofits. There's no longer any need to consider the driver technology – or carry a double stock of products. Thanks to their unique design, these tubes are a quick and easy fit with luminaires that operate on EM ballasts, HF Electronic ballasts or mains power connections.

New T5 LEDtubes

With InstantFit technology on board, the MASTER LEDtube T5 range offers quick and easy retrofit solutions that need no replacement wires. The new range includes a unique product in the market, the T5 InstantFit HO 1200mm LED tube that's designed to replace 54W fluorescent alternatives. For very demanding applications, the T5 UO 1500mm offers the highest lumen package of 5600 lm with high

performance up to 155 lm/W, making it the ideal retrofit for 80W fluorescent tubes. The T5 High Efficiency range is the ideal replacement for office applications, enabling more energy savings with a 50,000 hours lifetime. T5 MASTER LEDtubes have the highest compatibility performance* on electronic HF ballasts and thanks to electrically safe pins and the isolated driver, present no risk of shock during installation.

A T8 for every application

MASTER LEDtubes are available in 600mm, 1200mm and 1500mm lengths with a choice of up to three color temperatures – 3,000K, 4000K and 6500K. Each replaces a different fluorescent type, ensuring a light for every application including covered car parks, offices, schools, industry, healthcare, warehouses, cold rooms and corridors. The latest addition to this range, the MASTER LEDtube T8 food emphasizes the deep red of meat and poultry.

CorePro LEDtube T8

The new generation of CorePro LEDtubes T8 feature a shorter aluminium end cap and provide a wide beam of 240 degrees for a uniform light effect. With low energy consumption and an increased performance of up to 110 l/W, they're our most affordable LED tubes for budget applications like garages and storerooms, enabling immediate energy savings and a faster payback time.

Philips LED tube range



The installer's choice

If you're an installer there are even more reasons for you to choose Philips LED tubes. As you'd expect from the world's leading name in lighting, our quality and attention to detail mean that we can also make your life safer and easier.



HF compatibility

No wires to replace, no hassle changing drivers; our InstantFit solution works with High Frequency electronic ballasts, making it easy and safe for all installation methods. All you have to do is slot the tube into your existing fitting.

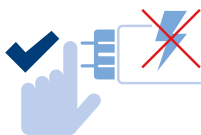

Pin safety

With Philips products you can safely touch the other end-cap when installing the tube. The integrated driver is also safely isolated from touchable parts. Philips LED tubes adhere to all UL and IEC pin safety requirements.



Rotating end-caps

In many applications the pin fitting needs to be rotated. This can be a problem as LED tubes only provide directional light. Our T8 MASTER LEDtubes have rotating end-caps to allow you to rotate the tube by up to 90 degrees. So you can always direct the light to best effect.

Finding the **right fit** for **T8 tubes**

1 Does your luminaire have a starter?

This illustration shows its typical location in an open or closed luminaire with 1200 and 1500 mm tubes.

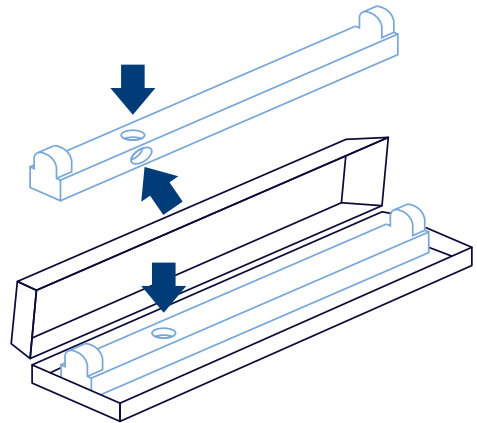

2 Yes.

The luminaire works with ElectroMagnetic ballasts. Simply replace the old starter with the new (EM) LED starter included in the packaging. Choose the LED tube with one ring on the cap.

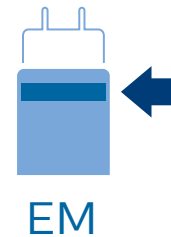
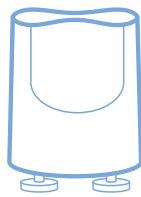
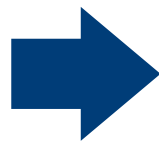
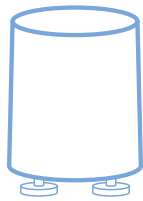

EM

No.

The luminaire works on High Frequency (HF) electronic ballasts. Choose MASTER LEDtube InstantFit with the end-cap with two rings. No need to change drivers or rewire. It's a plug and play solution that works straight out of the box. Quick and easy installation.

Check the [ballast compatibility list on www.philips.com/ledtube](http://www.philips.com/ledtube)



HF

3 No.

Your luminaire works on High Frequency (HF) electronic ballasts but you can't use MASTER LEDtube InstantFit or your ballast is not compatible. Cut wires, remove ballast and connect direct to mains. Use the MASTER LEDtube EM with one ring on the cap.

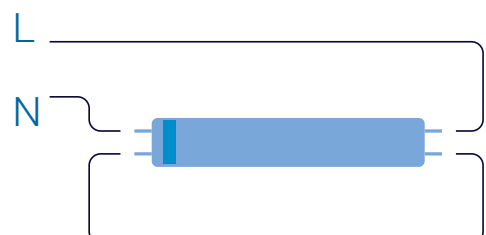

Finding the right T8 tube

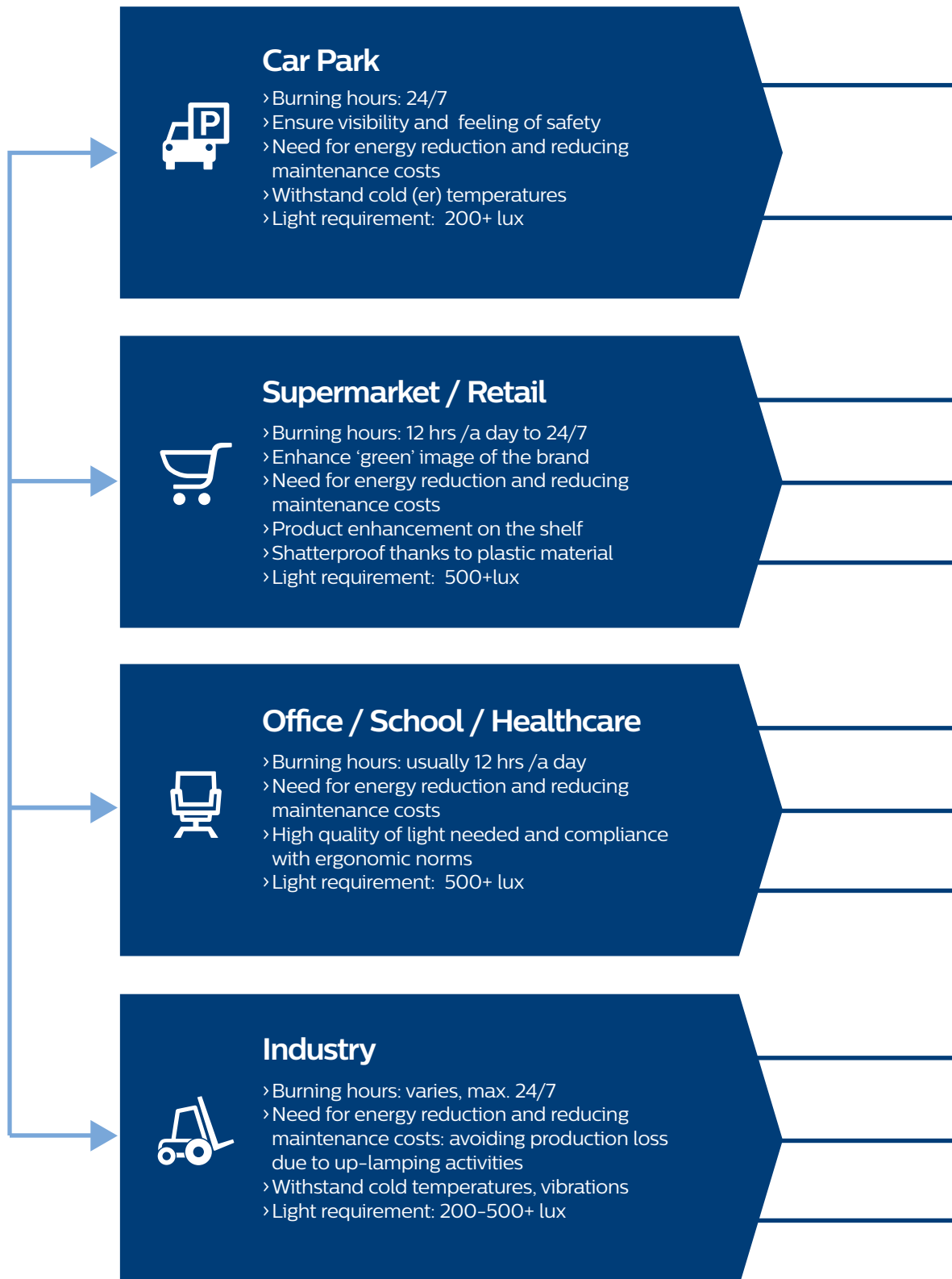

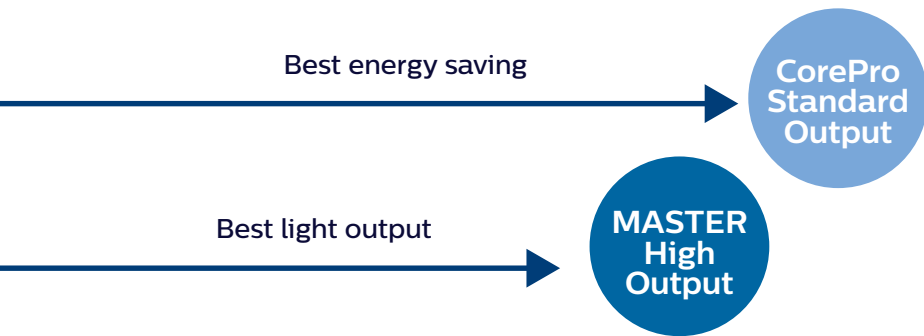

CorePro Standard Output
Up to 2000 lumen

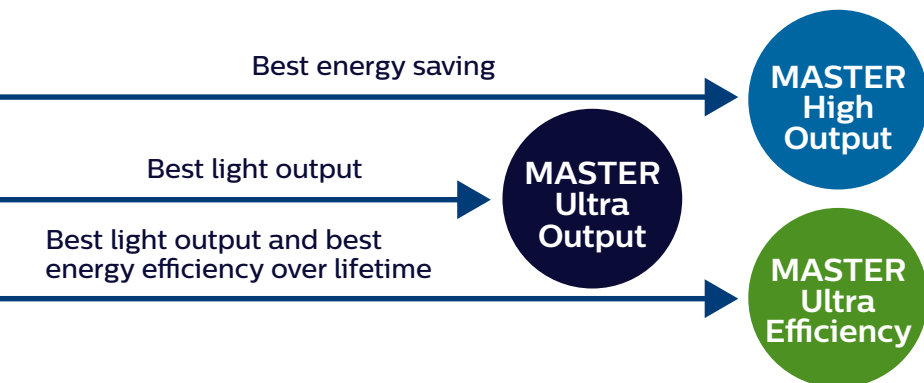

MASTER High Output
Up to 3100 lumen

MASTER Ultra Output
Up to 3700 lumen

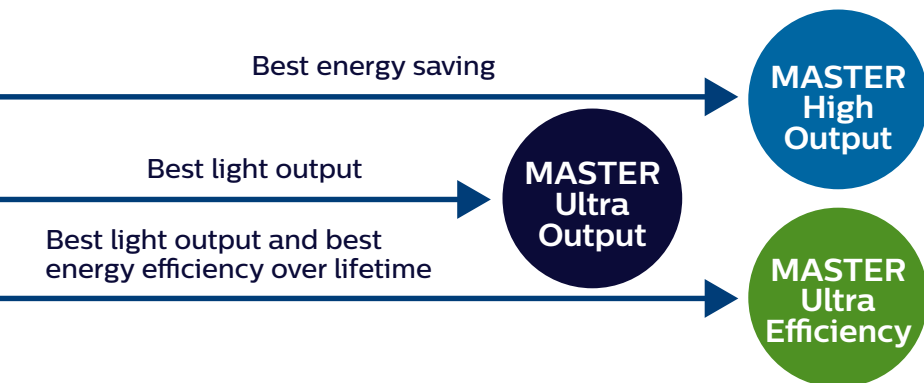

MASTER Ultra Efficiency
Up to 3700 lumen

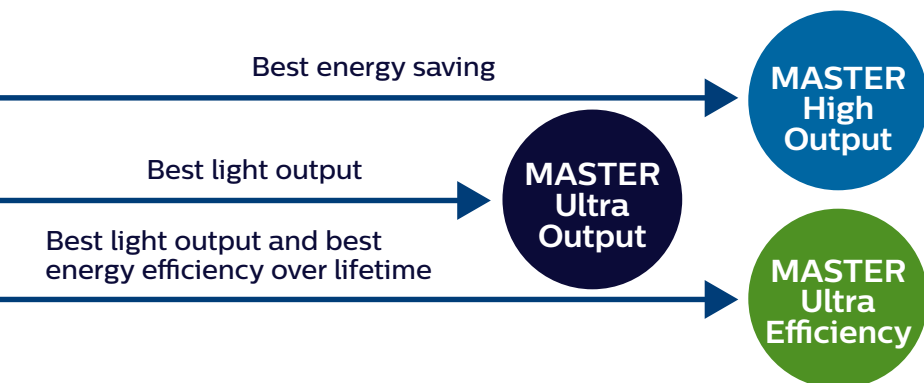

Use the **right** selector tool
www.philips.com/ledtubeselectortool

Finding the right output

For ultra-output applications, our solutions meet lighting industry standards (EN12464-1) by providing high light levels without causing discomfort or glare*.

Lux

Working, typing reading and data processing require sufficient light with a minimum lux level



Sufficient light

- › Key parameter for minimum required light is indicated in EN12464-1 in lux (lumens per square meter).
- › EN12464-1 prescribes minimum lux values, uniformity of illumination, and color rendering index, depending on the task.

Unified Glare Rating (UGR)

The amount of glare, annoyance or reflection created by high or non-uniform brightness must be kept to a minimum

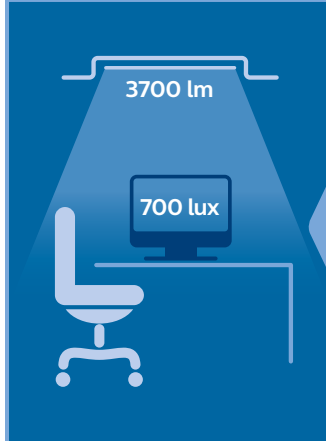

Discomfort glare

- › Sensation of annoyance or reflection caused by high or non-uniform brightness (eg. on computer screen).
- › Amount of glare is indicated in EN 12464-1 standard by Unified Glare Rating (UGR).

Lighting requirements

EN12464-1 prescribes minimum lux values, uniformity of illumination and color rendering index, depending on the task



Supermarkets / Retail

- › For Supermarket and Retail applications 500 lux counts as minimum value.
- › UGR standard for Supermarket applications is also set at max 19 UGR.



Industrial

- › For Industry applications, there are many sub segments, each having their own specific standards. In the storage industry segment 300 lux counts as minimum value.
- › UGR standard for Industry applications is set at max 25 UGR.



Office / School / Healthcare

- › For Office applications 500 lux counts as minimum value for writing, typing, reading, data processing, conference and meeting rooms.
- › UGR standard for Office applications is set at max 19 UGR.
- › For most Healthcare applications 200 lux counts as minimum value.
- › UGR standard for applications is set at max 22 UGR.

* Final light quality, besides the LED tube, also depends on application circumstances like e.g. type of luminaire used and amount of daylight.

CorePro LEDtube T8



The **most affordable** switch

The new generation of CorePro LEDtubes T8 feature a shorter aluminium end cap and provide a wide beam of 240 degrees for a uniform light effect. With low energy consumption and an increased performance of up to 110 l/W, they're our most affordable LED tubes for budget applications like garages and storerooms, enabling immediate energy savings and a faster payback time.

Now available with shorter end caps



240°
beam angle

- ✓ Glass housing
- ✓ Uniform light spread for car parks, storage rooms, warehouses
- ✗ Not for high lux applications like offices or industry

Finding the **right solution** for your application



New standard for car parks

Car parks and transportation networks need to feel bright and welcoming 24 hours a day. White LED light has a higher perceived brightness and superior color rendering, so people feel safer. And because LED is highly reliable and energy efficient, your customers will welcome the savings too.

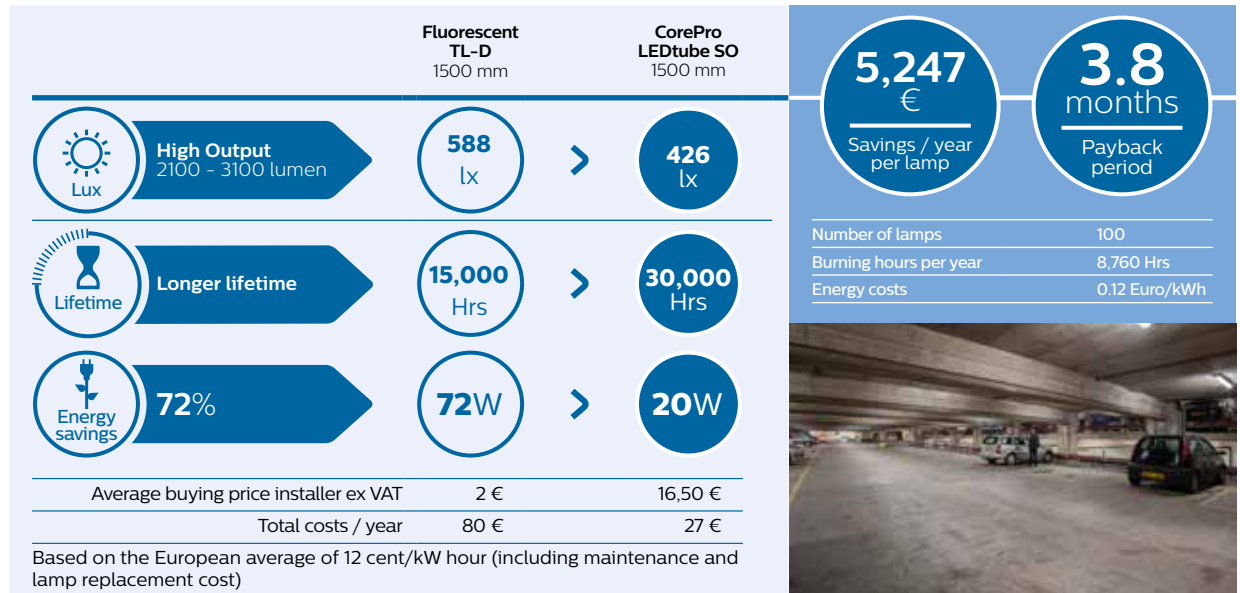

› Choose CorePro LED tubes **Standard Output** for the most **attractive** payback time.



High output for higher standards in car parks

High Output LEDtubes raise the standards in car parks even higher. With a light output of up to 3100 lumen they provide maximum visibility and safety – particularly important in car parks that operate right around the clock.

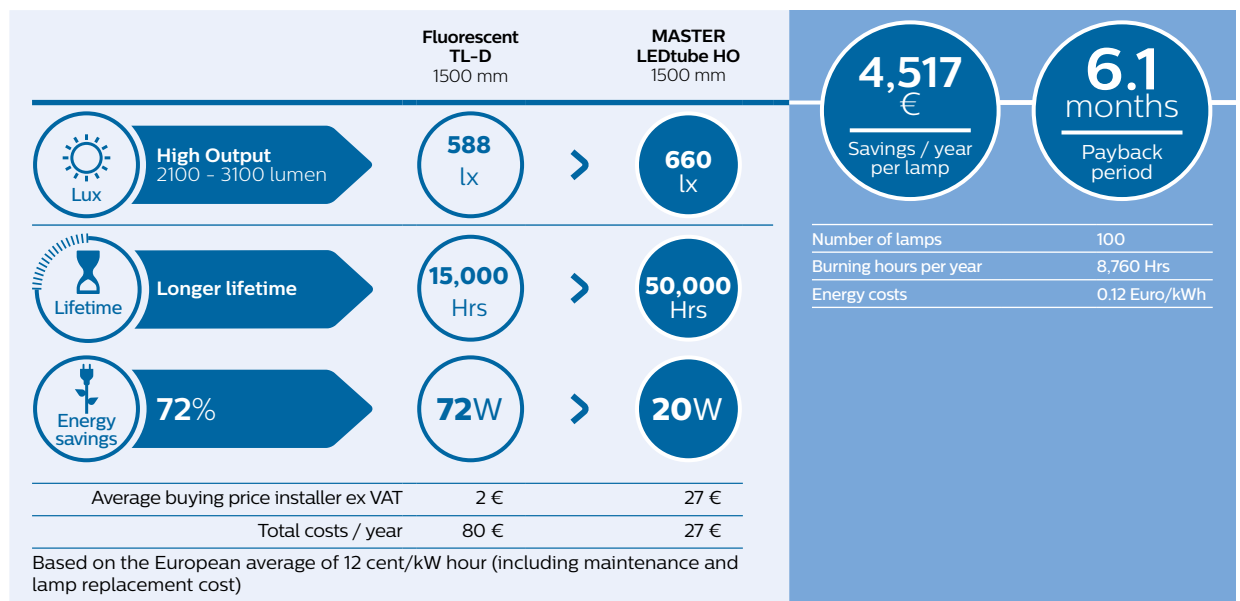

› Choose MASTER LED tubes **High Output** to reach **higher standards** for visibility and safety in car parks.



High output on the high street

Retail stores and hospitality venues know light has the power to attract. It creates irresistible displays, brings brands to life and encourages customers to spend longer in store. With our LED tubes you can light up sales at the same time as reducing energy and maintenance costs.

	Fluorescent TL-D 1500 mm		MASTER LEDtube HO 1500 mm
High Output 2100 - 3100 lumen	687 lx	>	567 lx
Longer lifetime	15,000 Hrs	>	50,000 Hrs
72%	72W	>	20W
Average buying price installer ex VAT	2 €		27 €
Total costs / year	40 €		13 €

Based on the European average of 12 cent/kW hour (including maintenance and lamp replacement cost)

3,986
€

Savings / year per lamp

12.2
months

Payback period

Number of lamps	150
Burning hours per year	4,380 Hrs
Energy costs	0.12 Euro/kWh



› Choose MASTER LED tubes **High Output** for high light output and **attractive payback time**.



Ultra output for demanding lighting applications in supermarkets and retail

Beautiful lighting brings out the best in the products on display and enhances the shopping experience for customers. But with lamps burning for up to 18 hours a day, food retailers want solutions that will reduce energy and maintenance costs – and show their green credentials in the best light.

	Fluorescent TL-D 1500 mm		MASTER LEDtube UO 1500 mm
High Output 2100 - 3100 lumen	687 lx	>	680 lx
Longer lifetime	15,000 Hrs	>	50,000 Hrs
67%	72W	>	24W
Average buying price installer ex VAT	2 €		33 €
Total costs / year	60 €		24 €

Based on the European average of 12 cent/kW hour (including maintenance and lamp replacement cost)

5,387
€

Savings / year per lamp

11
months

Payback period

Number of lamps	150
Burning hours per year	6,570 Hrs
Energy costs	0.12 Euro/kWh

› Choose MASTER LED tubes **Ultra Output** to optimize visibility of products on display and **enhance the shopping experience** for customers.



High output for offices

With a light output of up to 3100 lumen, our High Output LED tubes provide brilliant light quality with the best lumen per watt. A simple switch for offices and healthcare settings that saves on energy but feels bright and welcoming.

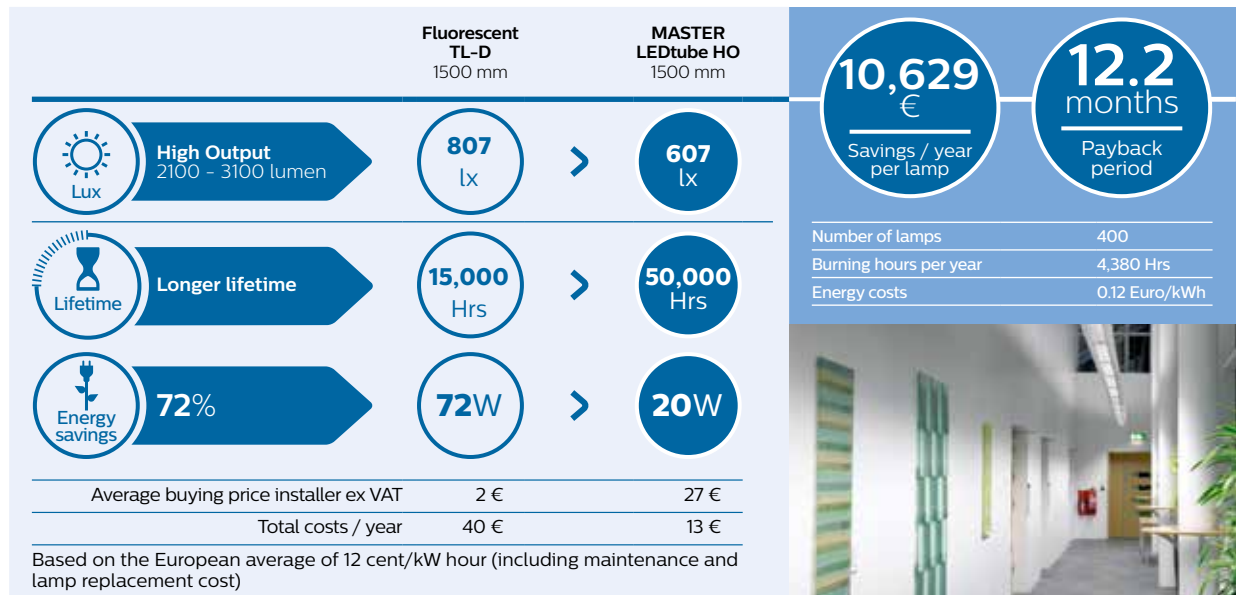

› Choose MASTER LED tubes **High Output** LED tube for a **simple switch** for offices and healthcare settings that save on energy.



Ultra output for more performance in offices

Office and school lighting can influence energy levels, performance and wellbeing. Our solutions shine with impressive, high quality light to create the most comfortable ambience that complies with all office norms and still saves on energy. So business is always a pleasure.

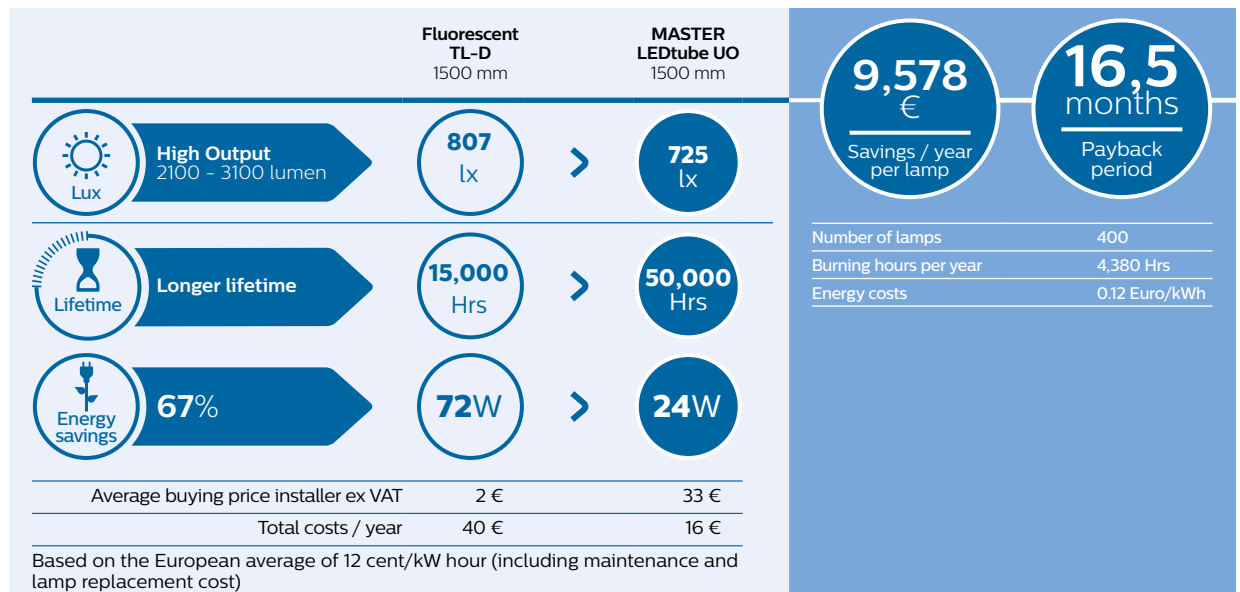

› Choose MASTER LED tubes **Ultra Output** to for **the best light output** in the most demanding office and healthcare applications.

Calculate your own savings on
www.philips.com/t8savingscalculator
www.philips.com/t5savingscalculator





Ultra output for industry applications

In ultra-demanding applications, our Ultra Output LEDtubes take safety and performance to the next level. With a super bright light output of up to 3700 lumen they offer the best light output for maximum visibility and minimal maintenance.

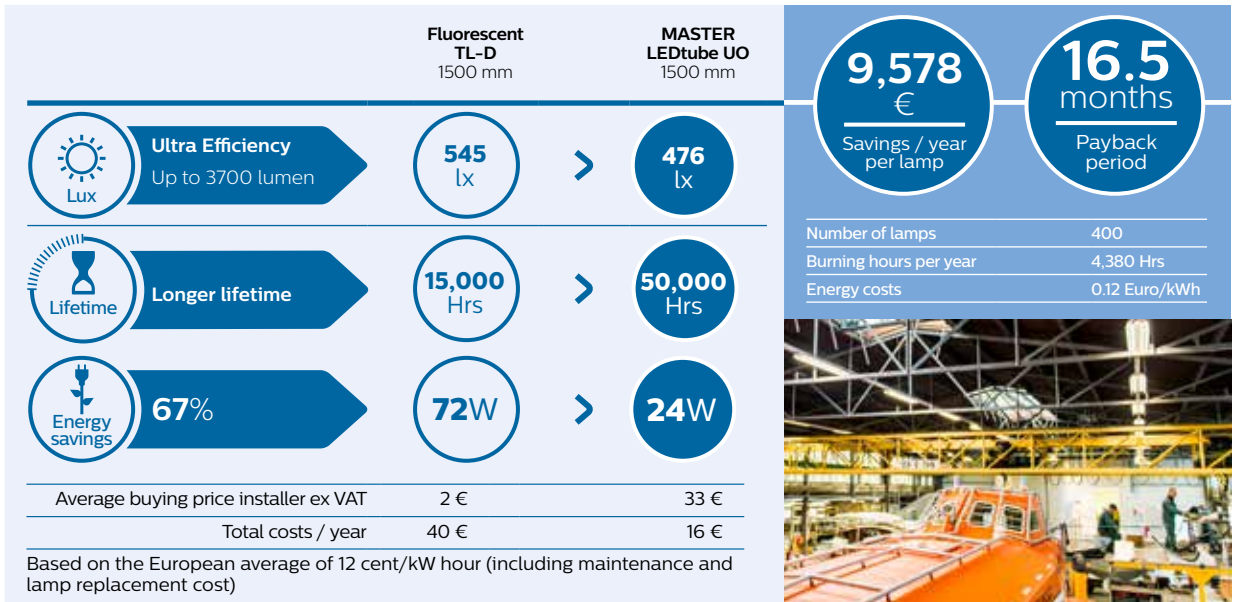

› Choose **MASTER LED tubes Ultra Output** to for the **best light output** in industry applications.



Ultra Efficient for extremely demanding industry applications

In ultra-demanding applications, 24/7 operations can run up expensive energy bills. With a super bright light output of up to 3700 lumen our Ultra Efficiency combine both the best light output for maximum visibility AND the highest lumen per watt efficiency. With an ultra-long lifetime of 60,000 hours, these lamps offer the best Total Cost of Ownership over lifetime.

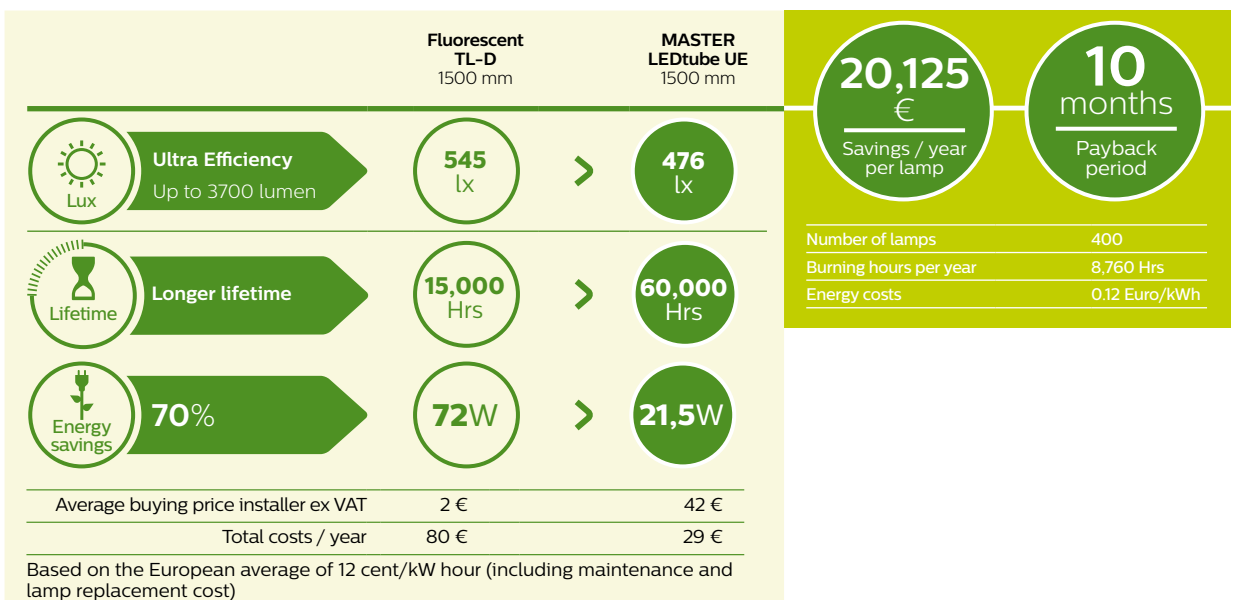

› Choose **MASTER LED tubes Ultra Efficiency** for the best light output in very demanding industry applications along with the **best Total Cost of Ownership** over lifetime.

Technical specifications

MASTER LEDtube T5 High Output

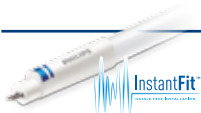

HF



3000 / 4000 / 6500



G5



NON-DIMMABLE



50,000 H



BEAM ANGLE



Product type	LED	Rotatable end cap	Lumen output	Operation	Beam angle	CRI	Color temperature	Energy label	EOC 1 pcs (C)
MASTER LEDtube (HF)	W		lm		°		K		8718696
1200mm HO 26W 830 T5 InstantFit	26	No	3700	HF	160	83	3000	A++	70527800
1200mm HO 26W 840 T5 InstantFit	26	No	3900	HF	160	83	4000	A++	70529200
1200mm HO 26W 865 T5 InstantFit	26	No	3900	HF	160	83	6500	A++	70531500
1500mm HO 26W 830 T5 InstantFit	26	No	3700	HF	160	83	3000	A+	68552500
1500mm HO 26W 840 T5 InstantFit	26	No	3900	HF	160	83	4000	A++	68554900
1500mm HO 26W 865 T5 InstantFit	26	No	3900	HF	160	83	6500	A++	68556300

MASTER LEDtube T5 Ultra Output

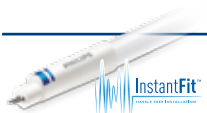

HF



3000 / 4000 / 6500



G5



NON-DIMMABLE



50,000 H



BEAM ANGLE



Product type	LED	Rotatable end cap	Lumen output	Operation	Beam angle	CRI	Color temperature	Energy label	EOC 1 pcs (C)
MASTER LEDtube (HF)	W		lm		°		K		8718696
NEW 1500mm UO 36W 830 T5 InstantFit	36	No	5200	HF	160	83	3000	A+	70599500
NEW 1500mm UO 36W 840 T5 InstantFit	36	No	5600	HF	160	83	4000	A++	70603900
NEW 1500mm UO 36W 865 T5 InstantFit	36	No	5600	HF	160	83	6500	A++	70605300



MASTER LEDtube T5 High Efficiency



HE



3000 / 4000 / 6500



G5



NON-DIMMABLE



50,000 H



BEAM ANGLE



Product type	LED	Rotatable end cap	Lumen output	Operation	Beam angle	CRI	Color temperature	Energy label	EOC 1 pcs (C)
MASTER LEDtube (HE)	W		lm		°		K		8718696
NEW 600mm HE 8W 830 T5	8	No	1000	HF	200	83	3000	A+	74323200
NEW 600mm HE 8W 840 T5	8	No	1050	HF	200	83	4000	A+	74325600
NEW 600mm HE 8W 865 T5	8	No	1050	HF	200	83	6500	A+	74327000
NEW 1200mm HE 16.5W 830 T5	16.5	No	2300	HF	200	83	3000	A+	74329400
NEW 1200mm HE 16.5W 840 T5	16.5	No	2500	HF	200	83	4000	A++	74331700
NEW 1200mm HE 16.5W 865 T5	16.5	No	2500	HF	200	83	6500	A++	74333100
NEW 1500mm HE 20W 830 T5	20	No	2800	HF	200	83	3000	A+	74335500
NEW 1500mm HE 20W 840 T5	20	No	3000	HF	200	83	4000	A++	74337900
NEW 1500mm HE 20W 865 T5	20	No	3000	HF	200	83	6500	A++	74339300



MASTER LEDtube T8 High Output

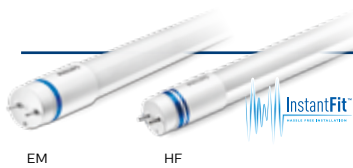

3000 / 4000 / 6500



G13





ROTATABLE
END CAP



50,000 H



BEAM ANGLE
160°

	Product type	LED	Lumen output	Operation	Beam angle	CRI	Color temperature	Dimmable*	Energy label	EOC 1 pcs (C)
	MASTER LEDtube (EM)	W	lm		°		K			8718696
	600mm HO 8W 830 T8	8	1000	EM & Mains	160	83	3000	No	A++	69747400
	600mm HO 8W 840 T8	8	1050	EM & Mains	160	83	4000	No	A++	69749800
	600mm HO 8W 865 T8	8	1050	EM & Mains	160	83	6500	No	A++	69751100
	900mm HO 12W 840 T8	12	1575	EM & Mains	160	83	4000	No	A++	68708600
	900mm HO 12W 865 T8	12	1575	EM & Mains	160	83	6500	No	A++	68710900
	1200mm HO 14W 830 T8	14	2000	EM & Mains	160	83	3000	No	A++	68718500
	1200mm HO 14W 840 T8	14	2100	EM & Mains	160	83	4000	No	A++	68720800
	1200mm HO 14W 865 T8	14	2100	EM & Mains	160	83	6500	No	A++	68722200
	1500mm HO 20W 830 T8	20	2900	EM & Mains	160	83	3000	No	A++	68712300
	1500mm HO 20W 840 T8	20	3100	EM & Mains	160	83	4000	No	A++	68714700
	1500mm HO 20W 865 T8	20	3100	EM & Mains	160	83	6500	No	A++	68716100
	MASTER LEDtube (HF)	W	lm		°		K			8718696
	600mm 10.5W 830 T8 InstantFit	10.5	1000	HF	160	83	3000	Yes	A+	5965900
	600mm 10.5W 840 T8 InstantFit	10.5	1050	HF	160	83	4000	Yes	A+	5967300
	600mm 10.5W 865 T8 InstantFit	10.5	1050	HF	160	83	6500	Yes	A+	5969700
	1200mm HO 14W 830 T8 InstantFit	14	2000	HF	160	83	3000	Yes	A+	68752900
	1200mm HO 14W 840 T8 InstantFit	14	2100	HF	160	83	4000	Yes	A++	68748200
	1200mm HO 14W 865 T8 InstantFit	14	2100	HF	160	83	6500	Yes	A++	68750500
	1500mm HO 20W 830 T8 InstantFit	20	2900	HF	160	83	3000	Yes	A+	68758100
	1500mm HO 20W 840 T8 InstantFit	20	3100	HF	160	83	4000	Yes	A++	68754300
	1500mm HO 20W 865 T8 InstantFit	20	3100	HF	160	83	6500	Yes	A++	68756700

* Dimming a LED tube: please refer to the site www.philips.com/ledtube for the latest update on our InstantFit LED tube/dimming ballast compatibility information.



MASTER LEDtube T8 Ultra Output

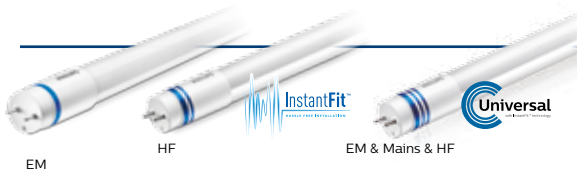

3000 / 4000 / 6500



G13



ROTATABLE
END CAP



50,000 H



160°
BEAM ANGLE

	Product type	LED	Lumen output	Operation	Beam angle	CRI	Color temperature	Dimmable*	Energy label	EOC 1 pcs (C)
	MASTER LEDtube (EM)	W	lm		°		K			8718696
	1200mm UO 16W 830 T8	16	2300	EM & Mains	160	83	3000	No	A++	68736900
	1200mm UO 16W 840 T8	16	2500	EM & Mains	160	83	4000	No	A++	68738300
	1200mm UO 16W 865 T8	16	2500	EM & Mains	160	83	6500	No	A++	68740600
	1500mm UO 24W 830 T8	24	3400	EM & Mains	160	83	3000	No	A++	68742000
	1500mm UO 24W 840 T8	24	3700	EM & Mains	160	83	4000	No	A++	68744400
	1500mm UO 24W 865 T8	24	3700	EM & Mains	160	83	6500	No	A++	68746800
	1800mm 25W 840 T8**	25	3700	EM & Mains	160	83	4000	No	A+	48037300
	MASTER LEDtube (HF)	W	lm		°		K			8718696
	1200mm UO 16W 830 T8 InstantFit	16	2300	HF	160	83	3000	Yes	A++	68800700
	1200mm UO 16W 840 T8 InstantFit	16	2500	HF	160	83	4000	Yes	A++	68796300
	1200mm UO 16W 865 T8 InstantFit	16	2500	HF	160	83	6500	Yes	A++	68798700
	1500mm UO 24W 830 T8 InstantFit	24	3500	HF	160	83	3000	Yes	A++	68806900
	1500mm UO 24W 840 T8 InstantFit	24	3700	HF	160	83	4000	Yes	A++	68802100
	1500mm UO 24W 865 T8 InstantFit	24	3700	HF	160	83	6500	Yes	A++	68804500
	MASTER LEDtube (UN)	W	lm		°		K			8718696
NEW	1200mm UO 16W 830 T8 Universal**	16	2300	EM & Mains & HF	160	83	3000	Yes	A++	72853600
NEW	1200mm UO 16W 840 T8 Universal**	16	2500	EM & Mains & HF	160	83	4000	Yes	A++	70537700
NEW	1200mm UO 16W 865 T8 Universal**	16	2500	EM & Mains & HF	160	83	6500	Yes	A++	70539100
NEW	1500mm UO 24W 830 T8 Universal**	24	3400	EM & Mains & HF	160	83	3000	Yes	A++	72851200
NEW	1500mm UO 24W 840 T8 Universal**	24	3700	EM & Mains & HF	160	83	4000	Yes	A++	70533900
NEW	1500mm UO 24W 865 T8 Universal**	24	3700	EM & Mains & HF	160	83	6500	Yes	A++	70535300

* Please refer to the site www.philips.com/ledtube for the latest information about ballast compatibility. Dimming a LED tube: please refer to the site www.philips.com/ledtube for the latest update on our InstantFit LED tube/dimming ballast compatibility information.



MASTER LEDtube T8 Ultra Efficiency

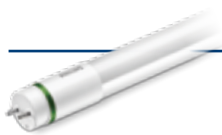

EM



4000 / 6500



G13



NON-DIMMABLE



60,000 H



BEAM ANGLE
160°



Product type	LED	Rotatable end cap	Lumen output	Operation	Beam angle	CRI	Color temperature	Energy label	EOC 1 pcs (C)*
	W		lm		°		K		8718696
NEW MASTER LEDtube (EM)									
NEW 1200mm UE 14.5W 840 T8	14,5	Yes	2500	EM & Mains	160	83	4000	A++	73150500
NEW 1200mm UE 14.5W 865 T8	14,5	Yes	2500	EM & Mains	160	83	6500	A++	73152900
NEW 1500mm UE 21.5W 840 T8	21,5	Yes	3700	EM & Mains	160	83	4000	A++	73154300
NEW 1500mm UE 21.5W 865 T8	21,5	Yes	3700	EM & Mains	160	83	6500	A++	73156700

MASTER LEDtube T8 Food

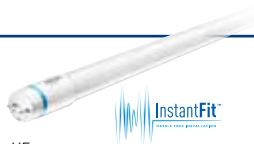

HF



3300



50,000 H



NON-DIMMABLE



BEAM ANGLE
160°



ROTATABLE (ROT)



G13



CRI

Product type	LED	Rotatable end cap	Lumen output	Operation	Beam angle	CRI	Color temperature	Energy label	EOC 1 pcs (C)
MASTER LEDtube	W		lm		°		K		8718696
1200mm 12W833 T8 food	12	No	1000	EM	160	83	3300	A+	76393300
1500mm 20W833 T8 food	20	No	1680	EM	160	83	3300	A+	76395700
900mm 8.5W833 T8 food	8,5	No	750	EM	160	83	3300	A+	76391900
1200mm 16.5W833 T8 food	16	No	1000	HF	160	83	3300	B	56616900

* Dimming a LED tube: please refer to the site www.philips.com/ledtube for the latest update on our InstantFit LED tube/dimming ballast compatibility information.

CoreProLED tube T8

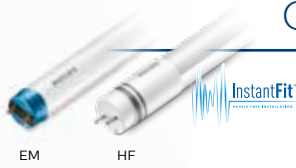

	Product type	LED	Rotatable end cap	Lumen output	Operation	Beam angle	CRI	Color temperature	Energy label	EOC 1 pcs (C)
	CorePro LED tube (EM)	W		lm		°		K		8718696
NEW	1500mm 20W 840 T8	20	No	2200	EM & Mains	240	80	4000	A+	71091300
NEW	1500mm 20W 865 T8	20	No	2200	EM & Mains	240	80	6500	A+	71095100
NEW	1200mm 14,5W 840 T8	14,5	No	1400	EM & Mains	240	80	4000	A+	71107100
NEW	1200mm 14,5W 865 T8	14,5	No	1400	EM & Mains	240	80	6500	A+	71109500
NEW	600mm 8W 840 T8	8	No	800	EM & Mains	240	80	4000	A+	71103300
NEW	600mm 8W 865 T8	8	No	800	EM & Mains	240	80	6500	A+	71105700
	CorePro LED tube (HF)	W		lm		°		K		8718696
	600mm 9W 840 T8 InstantFit	9	No	800	HF	240	80	4000	A	65217600
	600mm 9W 865 T8 InstantFit	9	No	800	HF	240	80	6500	A	65219000
	1200mm 15W 840 T8 InstantFit	15	No	1600	HF	240	80	4000	A+	58127800
	1200mm 15W 865 T8 InstantFit	15	No	1600	HF	240	80	6500	A+	58129200
	1500mm 20W 840 T8 InstantFit	20	No	2000	HF	240	80	4000	A+	59203800
	1500mm 20W 865 T8 InstantFit	20	No	2000	HF	240	80	6500	A+	59205200



Protection starter

Product type	EOC 10 pcs (I)
Accessory	8718291
Starter EMP	72928000



© 2017 Philips Lighting Holding B.V. All rights reserved. This document contains information relating to Philips Lighting product portfolio. Note that the information provided is subject to change. Philips Lighting does not give any representation or warranty as to the accuracy or completeness of the information included herein and shall not be liable for any action in reliance thereon. The information presented in this document is not intended as any commercial offer and does not form part of any quotation or contract. Trademarks are the property of Koninklijke Philips N.V., Philips Lighting Holding B.V. or their respective owners.

www.philips.com/ledtube