

**PHILIPS**

Ledinaire

 Trusted

 Reliable

 Great value

# Second rate or **simply great?**

Real professionals choose Philips Ledinaire  
for their **everyday lighting jobs**

**REAL  
PROs  
REAL  
QUALITY**



# Switching to LED has never been simpler

Count on honest, hard-working solutions that deliver what they promise. Get trusted performance and the results you expect with Philips-tested key components. And that for a price that's on your side! **Philips Ledinaire** – the essential range of trusted products for everyday lighting jobs that need good performance.

Trusted



What you need and expect is what you get. And that's a promise you can count on every time!

Reliable



Proven Philips quality. Every key component is tested for a **maximum of reliability** and long-term performance.

Great value



Perfect results shouldn't come with painful prices. With Ledinaire, you have **great value lighting** from the leader in LED.



## The Philips **Ledinaire** range of LED luminaires



Ledinaire batten



Ledinaire waterproof



Pentura mini LED



Ledinaire panel



Ledinaire recessed and Ledinaire surface-mounted



Ledinaire wall-mounted



Ledinaire downlight



Ledinaire slim downlight



Ledinaire Zadora LED



Ledinaire ClearAccent



Ledinaire floodlight mini/maxi/with sensor

## Ledinaire batten

Designed for general lighting and cove lighting applications.

### Features:

- Integrated and LEDtube versions available
- Integrated 1000 & 2000 lm and LEDtube-based 1600 & 3200 lm
- Light line up to ten battens for LEDtube version
- Mounting accessories included

### Benefits:

- **Trusted performance, low early failures**
- LEDtube versions for **easy replacement** of light sources



Producttype	Light output	Power	CCT	EOC
	lm	W	K	
BN060C 1xTLED16/840 L1200	1600	18	4000	871869907007999
BN060C 2xTLED16/840 L1200	3200	36	4000	871869907009399
BN012C LED10S/840 L600	1000	10	4000	871869908822599
BN012C LED20S/840 L1200	2000	20	4000	871869908822499

### Technical specifications

<b>Mains voltage</b>	220-240 V / 50-60 Hz
<b>Lifetime</b>	50,000 hrs L65
<b>CRI</b>	> 80
<b>Connection</b>	Flying leads/wires
<b>IP rating</b>	IP20
<b>Power factor</b>	0.9
<b>Safety class</b>	Class II
<b>Housing material</b>	Aluminum
<b>Color</b>	WH White

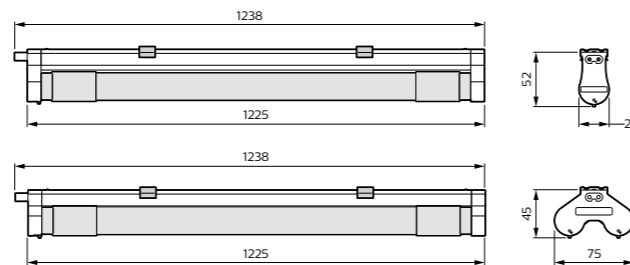

## Ledinaire waterproof

**NEW**

Professional quality waterproof LED luminaire for use in industrial and other waterproof settings.

### Features:

- **Robust and waterproof** luminaire, **new slim design**
- 600 mm & 1200 mm & 1500 mm length
- Mounting bracket can be positioned over full length
- Through-wiring versions available
- **Increased efficiency to 110 lm/W**

### Benefits:

- **Low height design with less dust accumulation**
- **New connector for easy installation**
- Diffuse comfortable light
- Philips quality and reliability



Producttype	Light output	Power	CCT	Length	EOC
	lm	W	K	mm	
WT060C LED18S/840 PSU L600	1800	16,5	4000	580	871869938910999
WT060C LED18S/840 PSU TW1 L600	1800	16,5	4000	580	871869938911699
WT060C LED36S/840 PSU L1200	3600	33	4000	1180	871869938912399
WT060C LED36S/840 PSU TW1 L1200	3600	33	4000	1180	871869938913099
WT060C LED56S/840 PSU L1500	5600	51	4000	1480	871869938914799
WT060C LED56S/840 PSU TW1 L1500	5600	51	4000	1480	871869938915499

### Technical specifications

<b>Mains voltage</b>	220-240 V / 50-60 Hz
<b>Lifetime</b>	50,000 hrs L65
<b>CRI</b>	> 80
<b>Connection</b>	Screw connection block
<b>IP rating</b>	IP65
<b>IK rating</b>	IK08
<b>Glow wire test</b>	850°
<b>Power factor</b>	0.9
<b>Safety class</b>	Class II
<b>Housing material</b>	Polycarbonate
<b>Color</b>	GR Grey (RAL7035)

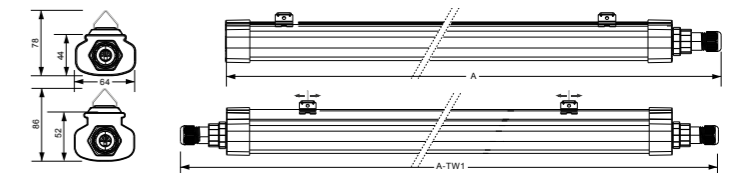

## Pentura mini LED

The ultimate integrated LED mini batten.

### Features:

- Ultra-slim LED batten
- Available in 300, 600, 900 and 1200 mm lengths
- 3000K & 4000K versions
- Non-trunkable version with on/off switch available.

### Benefits:

- Philips quality and reliability
- Energy saving
- Compact design



Producttype	Light output	Power	CCT	Length	EOC
	lm	W	K	mm	
BN132C LED12S/840 PSU L1200	1250	14	4000	1184	871869907243199
BN132C LED12S/830 PSU L1200	1250	14	3000	1184	871869907244899
BN132C LED9S/840 PSU L900	950	10	4000	884	871869907245599
BN132C LED9S/830 PSU L900	950	10	3000	884	871869907246299
BN132C LED6S/840 PSU L600	650	7	4000	584	871869907247999
BN132C LED6S/830 PSU L600	650	7	3000	584	871869907248699
BN132C LED3S/840 PSU L300	350	4	4000	324	871869907249399
BN132C LED3S/830 PSU L300	350	4	3000	324	871869907250999
BN133C LED6S/840 PSU L600	650	7	4000	584	871869907251699
BN133C LED6S/830 PSU L600	650	7	3000	584	871869907252399

### Technical specifications

<b>Mains voltage</b>	220-240 V / 50-60 Hz
<b>Lifetime</b>	50,000 hrs L65
<b>CRI</b>	> 80
<b>Connection</b>	Flying leads/wires
<b>IP rating</b>	IP40
<b>Power factor</b>	0.9
<b>Safety class</b>	Class II
<b>Housing material</b>	Polycarbonate
<b>Color</b>	WH White

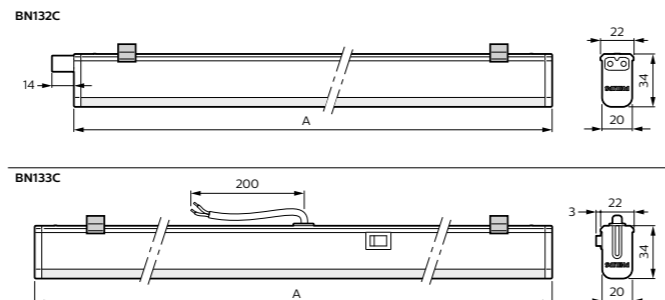

On/off switch BN133C

## Ledinaire panel

Energy efficient, professional luminaire for general lighting applications.

### Features:

- Single packs and 4-in-1 packs available
- Accessories for plaster, surface-mount and suspension available, safety cable included in 4-in-1 pack
- 3400 lm light output, 90 lm/W
- **New increased lifetime:** L70 at 50.000 hours

### Benefits:

- Trusted performance: **Philips quality tested driver**
- Steel frame for **extra robustness**
- **High quality lightguide to avoid early yellowing**



Producttype	Light output	Power	CCT	Dimension	EOC
	lm	W	K	mm	
RC065B LED34S/840 PSU W60L60 NOC 4PK	3400	38	4000	597x597	871869907328599
RC065B LED34S/840 PSU W60L60 OC 4PK	3400	38	4000	597x597	871869938647499
RC065B LED34S/840 PSU W60L60 NOC 1PK	3400	38	4000	597x597	871869979152000
RC065B LED34S/840 PSU W60L60 OC 1PK	3400	38	4000	597x597	871869979153700
RC066B LED34S/840 PSU W62L62 OC	3400	38	4000	625x625	871869938649800

### Technical specifications

<b>Mains voltage</b>	220-240 V / 50-60 Hz
<b>Lifetime</b>	50,000 hrs L70
<b>CRI</b>	> 80
<b>Connection</b>	Push-in with pull-relief
<b>IP rating</b>	IP20
<b>Power factor</b>	0.9
<b>Safety class</b>	Class II
<b>Housing material</b>	Painted steel
<b>Color</b>	WH White (RAL9016)

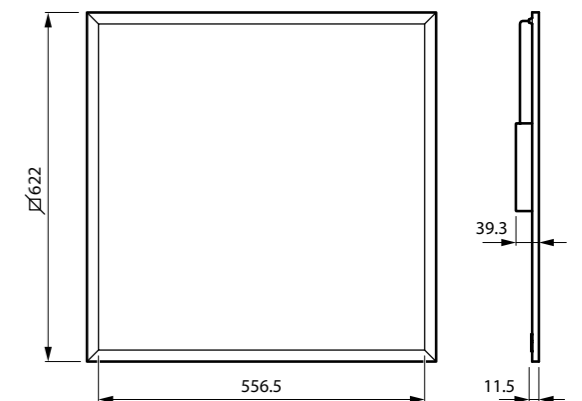

### Available mounting accessories

		EOC
<b>RC125Z SME-2 WH</b>	Suspension	07334699
<b>RC125Z SMB-PLC</b>	Plaster ceiling version (PCV)	07333999
<b>RC125Z SMB W60L60</b>	Surface-mounted (SM)	07330899
<b>RC125Z SC</b>	Safety cable	07335399

## Ledinaire recessed and Ledinaire surface-mounted

Energy efficient, professional luminaire for general lighting applications.

### Features:

- Square and rectangular versions available
- Recessed and surface-mounted versions
- 3000K & 4000K versions
- 3400 lm light output

### Benefits:

- Philips quality and reliability
- Energy saving
- Diffuse comfortable light



Producttype	Light output	Power	CCT	EOC
	lm	W	K	
RC060B LED32S/840 PSU W60L60	3200	36	4000	871869906958500
RC060B LED32S/830 PSU W60L60	3200	36	3000	871869906959200
RC060B LED32S/840 PSU W30L120	3200	36	4000	871869906960800
RC060B LED32S/830 PSU W30L120	3200	36	3000	871869906961500
SM060C LED32S/840 PSU W20L120	3200	36	4000	871869906962200
SM060C LED32S/830 PSU W20L120	3200	36	3000	871869906963900

### Technical specifications

Mains voltage	220-240 V / 50-60 Hz
Lifetime	50,000 hrs L65
CRI	> 80
Connection	Push-in with pull-relief
IP rating	IP20
Power factor	0.9
Safety class	Class I
Housing material	Painted steel
Color	WH White (RAL9003)

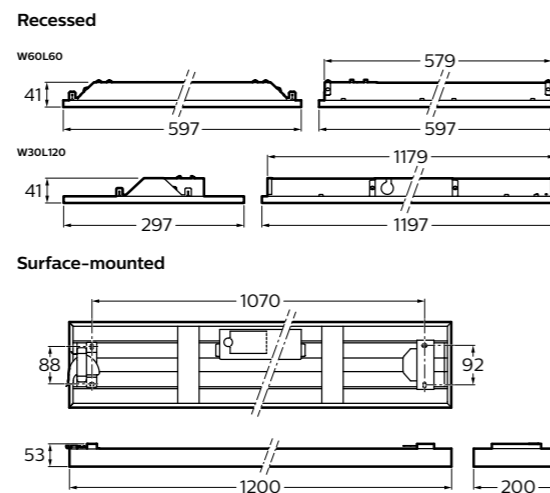

## Ledinaire wall-mounted

Energy efficient, professional wall-mounted luminaire for transportation areas.

### Features:

- 1100 lm & 1700 lm light output
- 3000K & 4000K versions
- Possibility for through wiring
- Optional motion detection and daylight sensor.

### Benefits:

- Philips quality and reliability
- Energy saving
- Diffuse comfortable light
- Easy to install



Producttype	Light output	Power	CCT	EOC
	lm	W	K	
WL060V LED11S/830 PSU II WH	1100	14.5	3000	871869938231599
WL060V LED11S/840 PSU II WH	1100	14.5	4000	871869938232299
WL060V LED17S/830 PSU II WH	1700	22	3000	871869938233999
WL060V LED17S/840 PSU II WH	1700	22	4000	871869938234699
WL060V LED17S/830 PSU MDU II WH	1700	22	3000	871869938235399
WL060V LED17S/840 PSU MDU II WH	1700	22	4000	871869938236099

### Technical specifications

Mains voltage	220-240 V / 50-60 Hz
Lifetime	50,000 hrs L70
Driver N	Non-dimmable driver (PSU)
CRI	> 80
Connection	Push-in connector
IP rating	IP44
Power factor	0.9
Safety class	Class II
Housing body material	Polycarbonate
Cover material	PMMA
Color	WH White

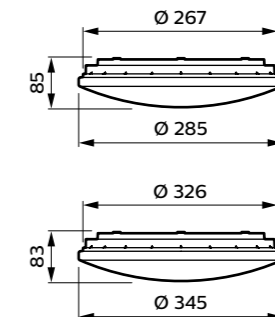

## Ledinaire downlight

Energy efficient, professional luminaire for general lighting applications.

### Features:

- 800 lm & 1800 lm light output
- 3000K & 4000K versions
- Modern, unobtrusive design



### Benefits:

- Philips quality and reliability
- Energy saving
- Diffuse comfortable light



Producttype	Light output	Power	CCT	EOC
	lm	W	K	
DN060B LED8S/830 PSU WH	800	9	3000	871869930662999
DN060B LED8S/840 PSU WH	800	9	4000	871869930664399
DN060B LED18S/830 PSU WH	1800	18	3000	871869930661299
DN060B LED18S/840 PSU WH	1800	18	4000	871869930663699

### Technical specifications

<b>Mains voltage</b>	220-240 V / 50-60 Hz
<b>Lifetime</b>	50,000 hrs L65
<b>Driver</b>	Non-dimmable driver (PSU)
<b>CRI</b>	> 80
<b>Connection</b>	Push-in with pull-relief
<b>IP rating</b>	IP20
<b>Power factor</b>	0.9
<b>Safety class</b>	Class I
<b>Housing body material</b>	Polycarbonate
<b>Reflector material</b>	Steel
<b>Diffuser material</b>	PMMA
<b>Color</b>	WH White (RAL9016)

#### LED8S

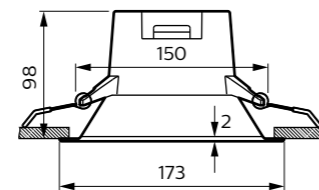
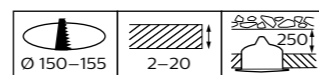

#### LED18S

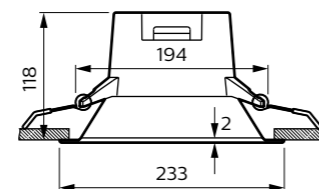
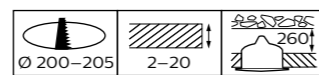

## Ledinaire slim downlight

Energy efficient, professional luminaire for general lighting applications.

### Features:

- 1000 lm & 2000 lm light output
- 3000K & 4000K versions
- Modern, unobtrusive and slim design



### Benefits:

- Philips quality and reliability
- Energy saving, when replacing conventional downlights
- Diffuse comfortable light
- Easy to fit various installations



Producttype	Light output	Power	CCT	EOC
	lm	W	K	
DN065B LED10S/830 PSU II WH	1000	11	3000	871869938175299
DN065B LED10S/840 PSU II WH	1000	11	4000	871869938176999
DN065B LED20S/830 PSU II WH	2000	23	3000	871869938177699
DN065B LED20S/840 PSU II WH	2000	23	4000	871869938178399

### Technical specifications

<b>Mains voltage</b>	voltage 220-240 V / 50-60 Hz
<b>Lifetime</b>	50,000 hrs L65
<b>Driver</b>	Non-dimmable driver (PSU)
<b>CRI</b>	> 80
<b>Connection</b>	Fly-wire with screw terminal
<b>IP rating</b>	IP20
<b>Power factor</b>	0.8
<b>Safety class</b>	Class II
<b>Housing body material</b>	Polycarbonate
<b>Diffuser material</b>	PMMA
<b>Color</b>	WH White (RAL9016)

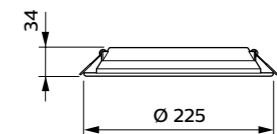
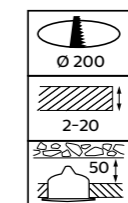
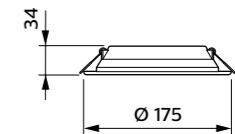
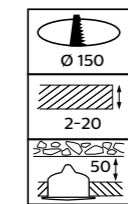

## Ledinaire Zadora LED

Recessed spot kit including replaceable LED lamp.

### Features:

- WH White or ALU Aluminium finish available
- 2700K, 3000K & 4000K versions
- Kits with different LED lamps available



### Benefits:

- Philips quality and reliability
- Energy saving
- Replaceable LED lamps
- High performance dimming
- Superior light quality with CRI90



Spot name	Lifetime (L70B50)	Beam angle	Dimmable
MASTER LEDspot Value	25,000 hrs	36D	Yes

Producttype	Light output	Power	CCT	EOC
	lm	W	K	
RS049B LED-MS-36-5W-2700-GU10 WH 50W	355	4.9	2700	871869907012399
RS049B LED-MS-36-5W-3000-GU10 WH 50W	365	4.9	3000	871869907015499
RS049B LED-MS-36-5W-4000-GU10 WH 50W	380	4.9	4000	871869907013099
RS049B LED-MS-36-5W-2700-GU10 ALU 50W	355	4.9	2700	871869907014799
RS049B LED-MS-36-5W-3000-GU10 ALU 50W	365	4.9	3000	871869907016199

### Technical specifications

<b>Mains voltage</b>	220-240 V / 50-60 Hz
<b>Lifetime</b>	25,000 hrs L70
<b>Driver</b>	Dimmable on leading and trailing edge dimmers*
<b>CRI</b>	90
<b>Connection</b>	Screw connection block
<b>IP rating</b>	IP20
<b>Power factor</b>	0.9
<b>Safety class</b>	Class II
<b>Housing material</b>	Polycarbonate
<b>Color</b>	WH White or ALU Aluminium

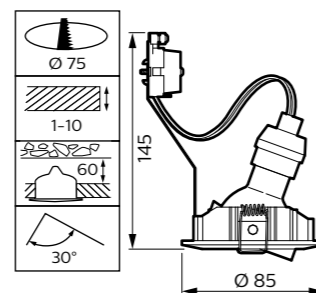

\* Please refer to the site [www.philips.com/masterledlamps](http://www.philips.com/masterledlamps) for the latest information about dimming compatibility for MASTER LEDlamps

## Ledinaire ClearAccent

LED Luminaire with integrated driver.

### Features:

- Fixed and adjustable versions available
- 3000K & 4000K versions
- 500 lm light output
- Modern, unobtrusive design



### Benefits:

- Philips quality and reliability
- Energy saving
- Faceted reflector look and feel
- Easy installation with driver on-board



Producttype	Light output	Power	CCT	EOC
	lm	W	K	
RS060B LED5-36-/830 PSR II WH	500	6	3000	871869907267799
RS060B LED5-36-/840 PSR II WH	500	6	4000	871869907268499
RS061B LED5-36-/830 PSR II WH	500	6	3000	871869907269199
RS061B LED5-36-/840 PSR II WH	500	6	4000	871869907270799

### Technical specifications

<b>Mains voltage</b>	220-240 V / 50-60 Hz
<b>Lifetime</b>	50,000 hrs L65
<b>Beam angle</b>	36 degrees
<b>Driver</b>	Dimmable driver (PSR)
<b>CRI</b>	> 80
<b>Connection</b>	Screw connection block
<b>IP rating</b>	IP20
<b>Power factor</b>	0.9
<b>Safety class</b>	Class II
<b>Housing material</b>	Aluminium
<b>Color</b>	WH White (RAL9010)

#### RS060B

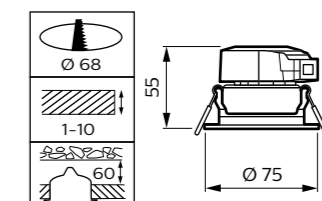

#### RS061B

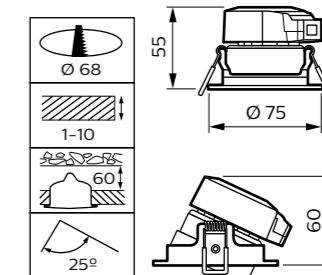

## Ledinaire floodlight

Energy efficient professional floodlight range for outdoor areas.

### Features:

- Available in mini, maxi and with motion sensor
- 10W/30W/50W/100W/200W
- IP65
- IK07 floodlight mini and with motion sensor, IK08 floodlight maxi
- Symmetrical beam
- 50 khrs L70B50
- Prewired connection

### Benefits:

- Good quality finishing and design
- Reliable driver, less early failures
- Light output to meet standard applications
- Easy to install, supplied with stripped cable



Ledinaire floodlight mini



Ledinaire floodlight maxi



Ledinaire floodlight with motion sensor

Family name	12NC	Product description	EOC
Ledinaire floodlight mini	912401483116	BVP105 LED9/840 PSU VWB100	871869938411199
Ledinaire floodlight mini	912401483117	BVP105 LED25/840 PSU VWB100	871869938412899
Ledinaire floodlight mini	912401483118	BVP105 LED45/840 PSU VWB100	871869938413599
Ledinaire floodlight maxi	912401483114	BVP106 LED100/740 PSU VWB100	871869938406799
Ledinaire floodlight maxi	912401483115	BVP106 LED200/740 PSU VWB100	871869938408100
Ledinaire floodlight with motion sensor	912401483141	BVP105 LED9/840 PSU VWB100 MDU	871869938486999
Ledinaire floodlight with motion sensor	912401483142	BVP105 LED25/840 PSU VWB100 MDU	871869938488399
Ledinaire floodlight with motion sensor	912401483143	BVP105 LED45/840 PSU VWB100 MDU	871869938490699

### Technical specifications

<b>Mains voltage</b>	220-240 V / 50-60 Hz
<b>Lifetime</b>	50,000 hrs L70
<b>CRI</b>	> 80
<b>Connection</b>	flying leads/wires
<b>IP rating</b>	IP65
<b>IK rating</b>	IK07 (IK08/maxi)
<b>Power factor</b>	0,98 (0,95/maxi)
<b>Safety class</b>	Class I
<b>Housing material</b>	Aluminium / Polycarbonate
<b>Color</b>	Dark Grey
<b>Controls</b>	motion sensor (only Ledinaire floodlight with motion sensor)

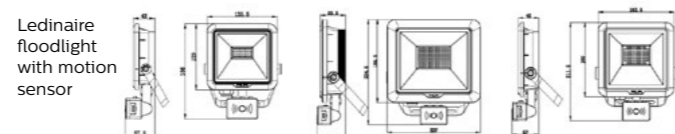
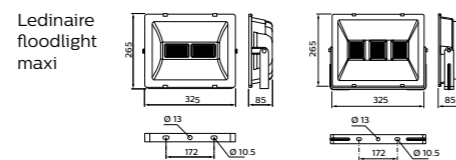
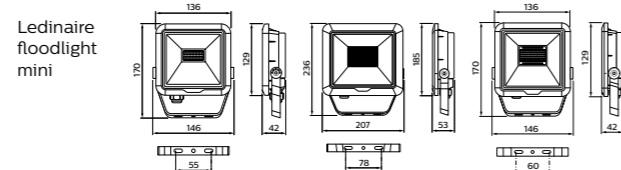

Costs a packet or  
**cost effective?**

**REAL  
PROS  
REAL  
QUALITY**



