

PHILIPS

LED Modules

Fortimo DLM

DLM Flex 2000lm



New Fortimo LED Downlight Module (DLM) Flex systems now provide you with the latest advances, including high quality LED options to satisfy both functional and performance requirements and excellent energy efficacies and color consistency.

And best of all, the Fortimo LED DLM Flex Module retains the familiar Fortimo DLM family footprint. Retaining the same footprint means that the OEM does not have to endure the hassles of retooling or redesigning fixtures or changing manufacturing processes.

When you're looking to create luminaires for practical and general lighting applications or have price-sensitive requirements, the Fortimo LED DLM Flex Module is the ideal solution.

Its direct white mid-power LED technology combines good light quality and energy efficiency up to 107 Lm/W with low initial costs while also offering low maintenance and a long lifetime of 50,000 hours.¹

Five lumen packages, including a new 5000lm option and four color temperatures (incl. 2700K), are available. The module can be operated at different currents. More information about such tuning can be found further on in the document.

Commercial Product Name	12NC
Fortimo LED DLM Flex 2000/827 Gen1 NA	9290 009 46506
Fortimo LED DLM Flex 2000/830 Gen1 NA	9290 009 46606
Fortimo LED DLM Flex 2000/835 Gen1 NA	9290 009 46706
Fortimo LED DLM Flex 2000/840 Gen1 NA	9290 009 46806

Associated Drivers

Commercial product name	Dimming Mechanism
XI025C100V045DNMX	0-10V dimming
XI036C100V048DNMX	0-10V dimming

See last page for footnotes.

Fortimo LED DLM Flex 2000lm

Features

- High energy efficiency of up to 107 lm/W
- High lumen packages up to 5,000 lm
- Smart system with Rset and thermal feedback
- Ability to operate module at a desired current
- Good quality of light with CRI 80 and 3 SDCM color consistency
- 50,000 hrs of life at L70 lumen maintenance¹
- One-stop shop for your system (detailed list of complementary partners in design-in guide)

Benefits

- Good performance at an economic price point
- Flexibility to tune the performance as per your need by modifying the operating point
- UL SREC compliance enables fixture design without additional thermal protection
- Luminaire manufacturability and ease of design-in
- Excellent thermal management
- Smart systems with Xitanium drivers
- Covered by Philips limited warranty²

Application

- Offices
- Educational institutions
- Healthcare
- General lighting areas
- High ceiling applications

Optical Characteristics – Table per CCT

Fortimo LED DLM Flex 2000lm 827

Parameter	Min	Typ	Max	Unit
Typical Luminous Flux ³		2000		lm
Module Efficiency		86.9		lm/W
Forward Voltage	33.9	35.1	37.9	V
Nominal Current		680		mA
Correlated Color Temperature ⁴		2700		K
Color Consistency		3		SDCM
CRI	80			-
Radiation Angle ⁵		110		deg
Thermal Power		16.7		W

Note: Specifications stated at Tc nom = 75°C

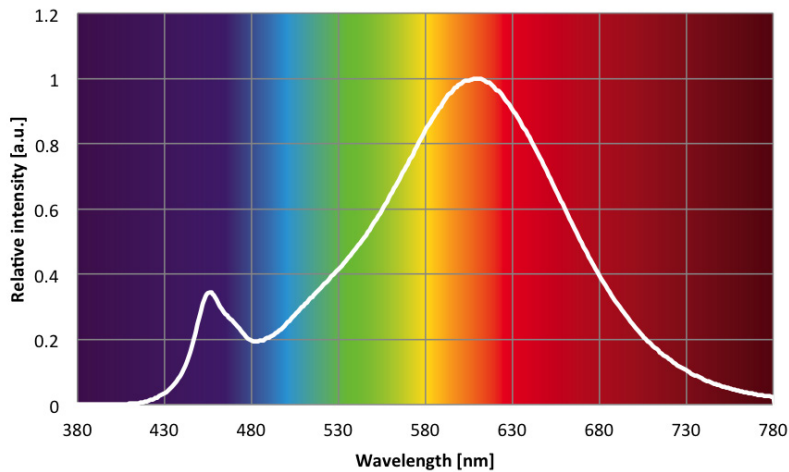

Fortimo LED DLM Flex 2000lm

Optical Characteristics – Table per CCT

Fortimo LED DLM Flex 2000lm 830				
Parameter	Min	Typ	Max	Unit
Typical Luminous Flux ³		2000		lm
Module Efficiency		96.9		lm/W
Forward Voltage	33.5	34.6	37.4	V
Nominal Current		600		mA
Correlated Color Temperature ⁴		3000		K
Color Consistency		3		SDCM
CRI	80			-
Radiation Angle ⁵		110		deg
Thermal Power		14.5		W

Note: Specifications stated at Tc nom = 75°C

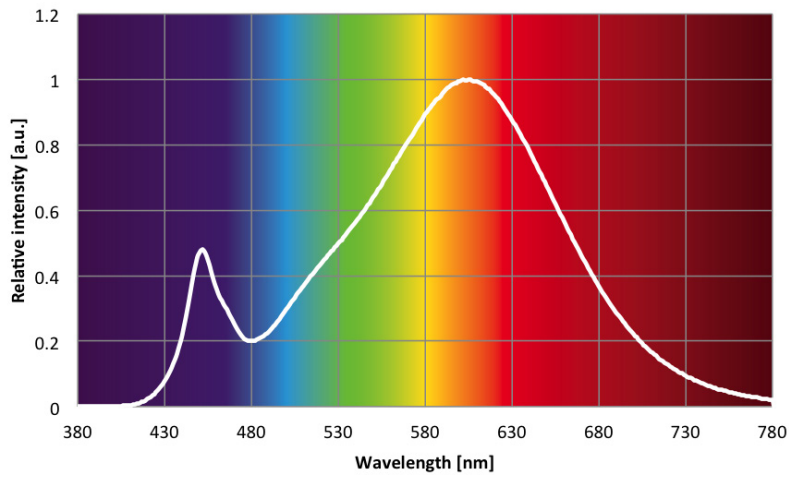

See last page for footnotes.

Fortimo LED DLM Flex 2000lm

Optical Characteristics – Table per CCT

Fortimo LED DLM Flex 2000lm 835				
Parameter	Min	Typ	Max	Unit
Typical Luminous Flux ³		2000		lm
Module Efficiency		99.3		lm/W
Forward Voltage	33.4	34.5	37.3	V
Nominal Current		580		mA
Correlated Color Temperature ⁴		3500		K
Color Consistency		3		SDCM
CRI	80			-
Radiation Angle ⁵		110		deg
Thermal Power		14		W

Note: Specifications stated at Tc nom = 75°C

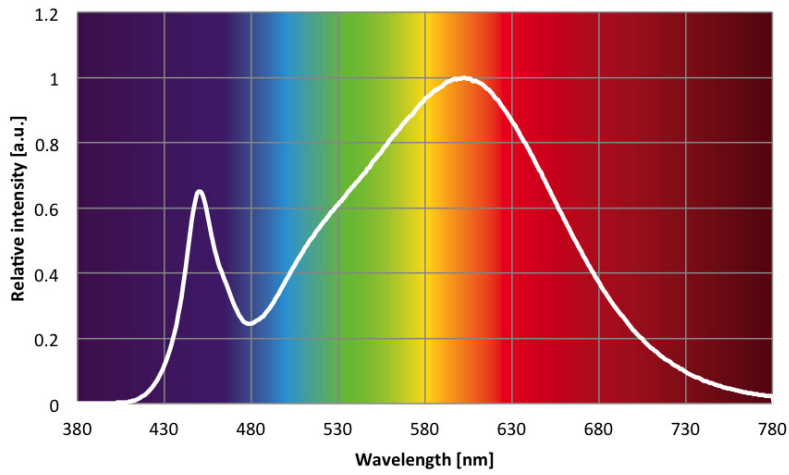

See last page for footnotes.

Fortimo LED DLM Flex 2000lm

Optical Characteristics – Table per CCT

Fortimo LED DLM Flex 2000lm 835				
Parameter	Min	Typ	Max	Unit
Typical Luminous Flux ³		2000		lm
Module Efficiency		102		lm/W
Forward Voltage	33.4	34.5	37.3	V
Nominal Current		580		mA
Correlated Color Temperature ⁴		4000		K
Color Consistency		3		SDCM
CRI	80			-
Radiation Angle ⁵		110		deg
Thermal Power		13.5		W

Note: Specifications stated at Tc nom = 75°C

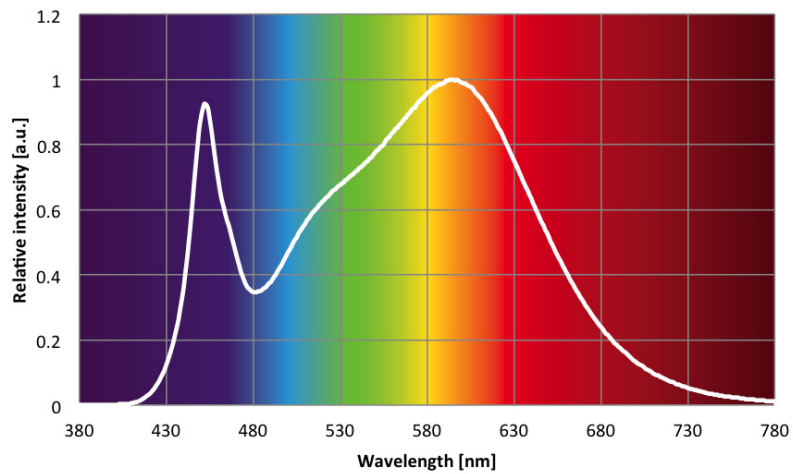

See last page for footnotes.

Fortimo LED DLM Flex 2000lm

Beam Shape

The Philips Fortimo LED DLM Flex generates a near Lambertian beam shape, which is a pragmatic starting point for OEMs wishing to design secondary optics.

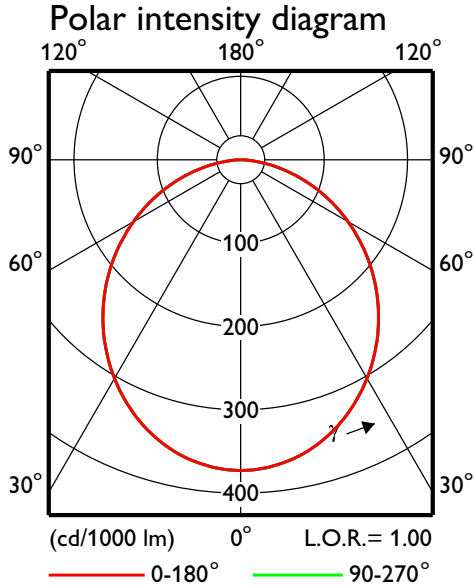

Electrical Characteristics

Parameter	Nominal Current (mA)	Typ Forward Voltage (V)	Typ Module Power (W)
Fortimo LED DLM 2000lm 827	680	35.1	24
Fortimo LED DLM 2000lm 830	600	34.6	20.8
Fortimo LED DLM 2000lm 835	580	34.5	20.1
Fortimo LED DLM 2000lm 840	580	34.5	20.1

Note: Specifications stated at Tc nom = 75°C

Lifetime

Parameter	Min	Typ	Max	Unit
Lumen Maintenance B50L70	50,000			hrs

Note: Specifications stated at Tc nom = 75°C and nominal current

Parameter	Nominal ⁶	Life ⁷	Safety ⁸
Tc (°C)	75	85	85
Current (mA)		700	1350

Fortimo LED DLM Flex 2000lm

Warranted Number of Full Thermal Product cCycles @ 25°C Ambient Temperature

Case temperature Tc [°C]	Amount of cycles
35	
40	14,600
45	
50	14,600
55	
60	14,600
65	
70	12,000
75	
80	8,000
85	
90	
95	

Abs Max Ratings

Parameter	Min	Max	Unit
Current Imax		1350	mA
Case Temperature Tc Max		85	°C
ESD Contact Discharge (IEC 614000-4-2)		8	kV
Storage Temperature	-40	75	°C

Fortimo LED DLM Flex 2000lm

Mechanical Characteristics

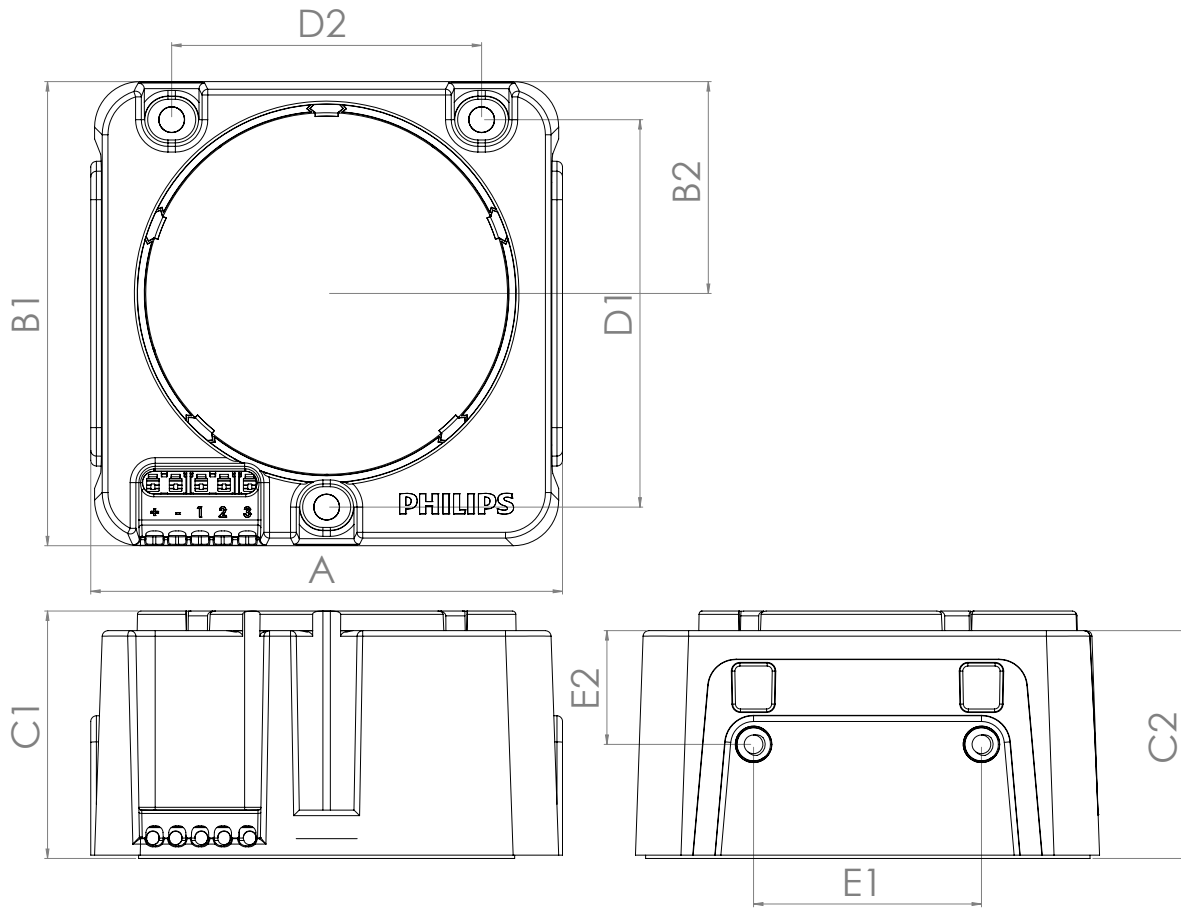

A (mm)	B1 (mm)	B2 (mm)	C1 (mm)	C2 (mm)	D1 (mm)	D2 (mm)	E1 (mm)	E2 (mm)
82.8	81.5	37.2	43.4	40	68	54.4	40	20

Application Information

Compliance and Approval

CSA/ UL 8750/ UL SREC

Environmental

RoHS

Application Information

IP Rating	No IP rating
Overheating Protection	UL SREC

Fortimo LED DLM Flex 2000lm

Tuning Information

Flux and Efficacy Versus Current (at Nominal Temperature) 2000lm

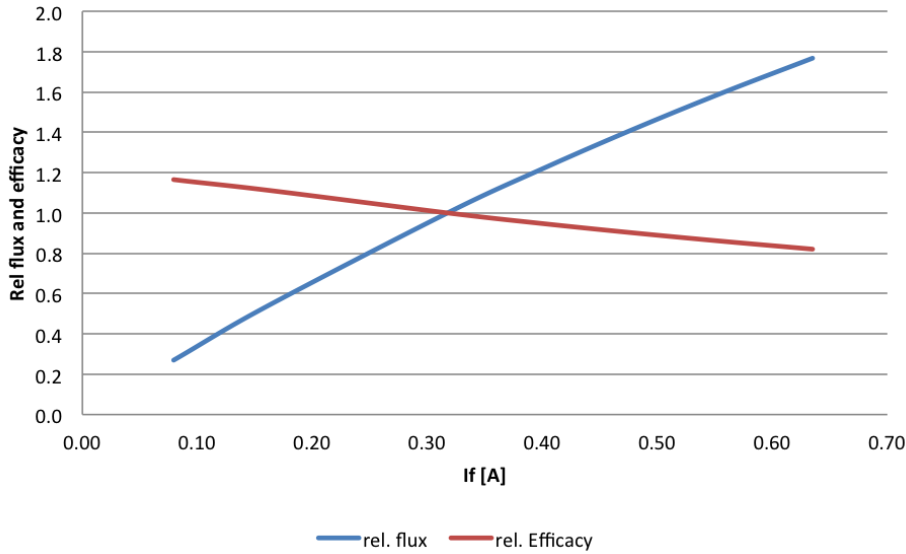

% of nominal current	Rel. flux	Rel. efficacy
25%	27%	116%
50%	53%	111%
100%	100%	100%
125%	121%	95%
150%	141%	90%
175%	159%	86%
200%	177%	82%

Flux and Efficacy Versus Temperature (at Nominal Current) 2000lm

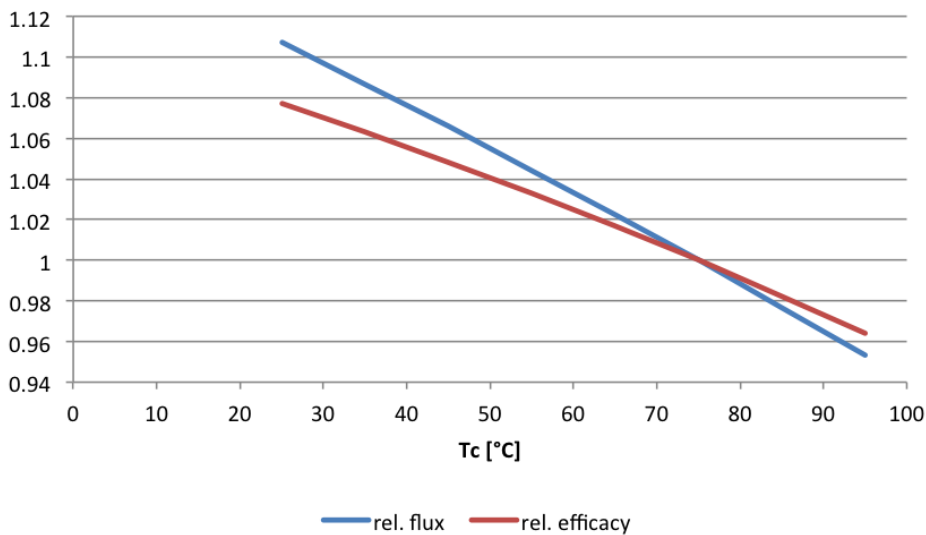

Tc	Rel. flux	Rel. efficacy
25	111%	108%
35	109%	106%
45	107%	105%
55	104%	103%
65	102%	102%
75	100%	100%
85	98%	98%
95	95%	96%

Fortimo LED DLM Flex 2000lm

Lumen Maintenance

Fortimo LED DLM Flex 2000lm

Lumen Maintenance Nominal Conditions

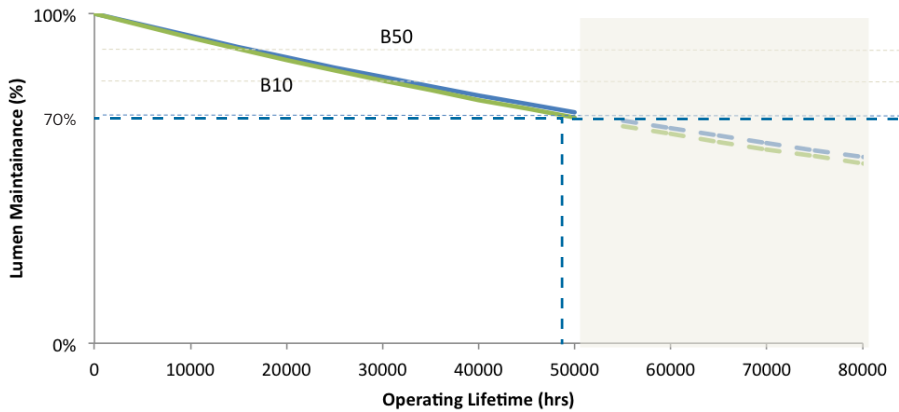

Lumen Maintenance (B50)

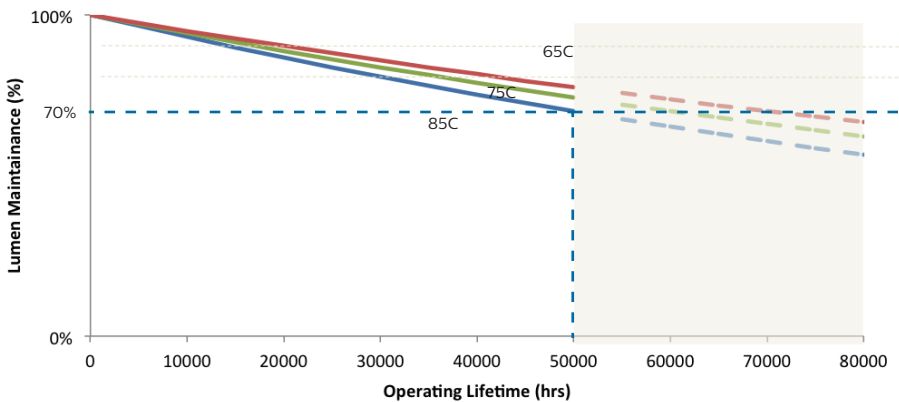

1. Average rated life is based on engineering data testing and probability analysis. The hours are at the B50, L70 point - 50,000 hours life with 70% lumen maintenance at Tc point.
2. View limited warranty at http://www.usa.lighting.philips.com/connect/tools_literature/warranties.wpd for details and restrictions.
3. Luminous flux of 100% of all production units fall between -10% and +20% of the listed value.
4. Correlated Color Temperature (CCT) complies with ANSI C78.377A Specifications.
5. Radiation angle falls between -10% and 10% of the listed value.
6. Nominal value at which performance is specified.
7. Value at which lifetime is specified (max current and Tc for warranty).
8. Maximum value for safety.

© 2015 Koninklijke Philips N.V. All rights reserved.
 Philips reserves the right to make changes in specifications and/or to discontinue any product at any time without notice or obligation and will not be liable for any consequences resulting from the use of this publication.
philips.com/leddrivers



Philips Lighting North America Corporation
 10275 W. Higgins Road, Rosemont IL 60018
 Tel: 800-322-2086 Fax: 888-423-1882
 Customer/Technical Service: 800-372-3331
 OEM Support: 866-915-5886

Imported by: Philips Lighting
 A division of Philips Electronics Ltd.
 281 Hillmount Rd, Markham, ON, Canada L6C 2S3
 Tel. 800-668-9008