

PHILIPS

LED Modules

Fortimo SLM

Fortimo LED SLM Gen 4 1100lm L13

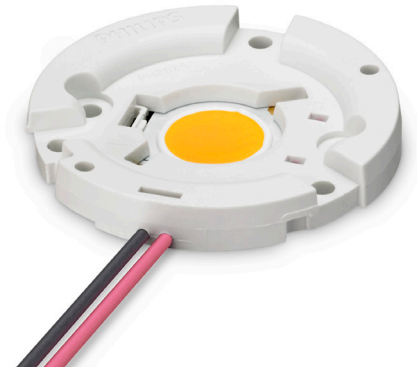

The Fortimo LED SLM Gen 4 is a next generation solution for spotlight and downlight applications. It is a product in line with the Fortimo brand promise of light quality and a smart system. We provide you with a system proposition ranging from 1100lm to 4500lm in preset outputs, with the flexibility to tune as per your needs.

This module is available in the following options. It is possible to combine these with any of the drivers as described in the design-in guide available at www.philips.com/ledmodulesna. A list of possible Rsets is provided below to set the output current of Philips Xitanium LED driver at different levels. More information about tuning can be found further on in the document.

Commercial Product Name	12NC
Fortimo LED SLM 1100lm 827 L13 G4	9290 009 01506
Fortimo LED SLM 1100lm 830 L13 G4	9290 009 01606
Fortimo LED SLM 1100lm 835 L13 G4	9290 009 49006
Fortimo LED SLM 1100lm 840 L13 G4	9290 009 01706
Fortimo LED SLM 1100lm 927 L13 G4	9290 009 49206

Associated Rsets

Material Description	12NC	Resistance (Ω)	Type
Fortimo LED Rset2 NA 300mA	929000727713	560	Push in
Fortimo LED Rset2 NA 500mA	929000727813	1200	Push in
Fortimo LED Rset2 NA 750mA	929000727913	2050	Push in

Associated Drivers

Driver List	Dimming Mechanism	Current Setting Mechanism
XI013C030V048DNM1	0-10V dimming	Rset2
XI020C050V042RNP1	Leading Edge and Trailing Edge	Dip Switch
XI025C100V045DNM1	0-10V dimming	Rset2

Fortimo LED SLM Gen 4 1100lm L13

Features

- Ability to operate your module at a desired current to get a certain lumen output with a high lm/W or lm/S
- High lumen output out of small Light Emitting Surface (LES) sizes for narrow beam angles and small reflector designs with punch
- High Tc nominal of 85°C
- Zhaga standardized high quality holder concept
- High quality of light

- Dedicated solutions for special needs including the SLM Crisp White
- One-stop shop for your system (detailed list of complementary partners in design-in guide)

Benefits

- High energy efficiency
- Flexibility to tune the performance as per your need by modifying the operating point
- Luminaire manufacturability and ease of design-in
- Excellent thermal management
- Smart systems with Xitanium drivers
- Covered by Philips limited warranty¹

Application

- SLM Gen 4 for accent lighting and down lighting for retail, hospitality and supermarkets
- SLM Crisp White is ideal when bright and clean whites and rich and saturated colors are needed

Optical Characteristics – Table per CCT

Fortimo LED SLM 1100lm L13 827

Parameter	Min	Typ	Max	Unit
Luminous Flux	1040	1160	1280	lm
Module Efficiency		114		lm/W
Correlated Color Temperature		2700		K
Color Coordinates		(0.458, 0.410)		-
Color Consistency		3		SDCM
CRI		>80		-
Radiation Angle		115		deg
Thermal Power		7		W

Note: Specifications stated at Tc nom = 85°C and I nom = 300 mA

Parameter	Min	Typ	Max	Unit
Luminous Flux	1620	1810	2000	lm
Module Efficiency		101		lm/W
Thermal Power		13.1		W

Note: Specifications stated at Tc nom = 85°C and I = 500 mA

Ri	R1	R2	R3	R4	R5	R6	R7	R8	R9	R10	R11	R12	R13	R14	R15
82	80	91	96	77	79	88	83	60	14	79	74	72	82	98	74

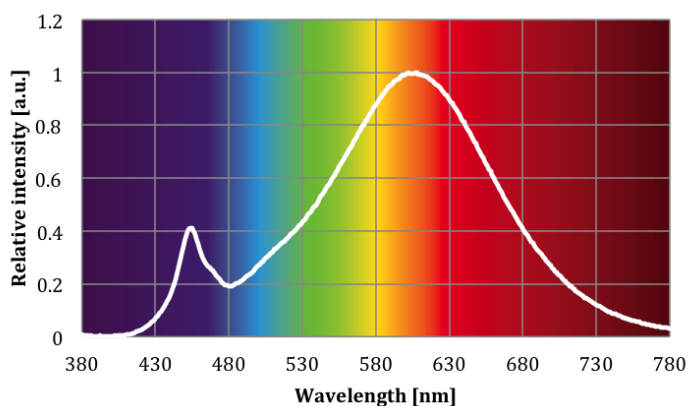

1. View limited warranty at http://www.usa.lighting.philips.com/connect/tools_literature/warranties.wpd for details and restrictions.

Fortimo LED SLM Gen 4 1100lm L13

Optical Characteristics – Table per CCT

Fortimo LED SLM 1100lm L13 830

Parameter	Min	Typ	Max	Unit
Luminous Flux	1110	1240	1370	lm
Module Efficiency		122		lm/W
Correlated Color Temperature		3000		K
Color Coordinates		(0.434,0.403)		-
Color Consistency		3		SDCM
CRI		>80		-
Radiation Angle		115		deg
Thermal Power		6.8		W

Note: Specifications stated at Tc nom = 85°C and I nom = 300 mA

Parameter	Min	Typ	Max	Unit
Luminous Flux	1750	1950	2150	lm
Module Efficiency		109		lm/W
Thermal Power		12.8		W

Note: Specifications stated at Tc nom = 85°C and I = 500 mA

Ri	R1	R2	R3	R4	R5	R6	R7	R8	R9	R10	R11	R12	R13	R14	R15
82	80	92	95	76	79	89	83	60	12	81	72	68	83	98	74

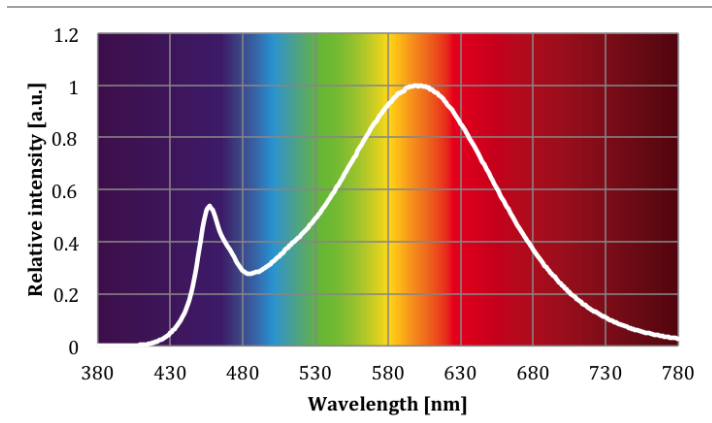

Fortimo LED SLM Gen 4 1100lm L13

Optical Characteristics – Table per CCT

Fortimo LED SLM 1100lm L13 835

Parameter	Min	Typ	Max	Unit
Luminous Flux	1160	1290	1420	lm
Module Efficiency		127		lm/W
Correlated Color Temperature		3500		K
Color Coordinates		(0.407, 0.392)		-
Color Consistency		3		SDCM
CRI		>80		-
Radiation Angle		115		deg
Thermal Power		6.7		W

Note: Specifications stated at Tc nom = 85°C and I nom = 300 mA

Parameter	Min	Typ	Max	Unit
Luminous Flux	1820	2030	2240	lm
Module Efficiency		113		lm/W
Thermal Power		12.6		W

Note: Specifications stated at Tc nom = 85°C and I = 500 mA

Ri	R1	R2	R3	R4	R5	R6	R7	R8	R9	R10	R11	R12	R13	R14	R15
81	78	89	96	76	78	85	84	61	7	75	73	62	81	98	73

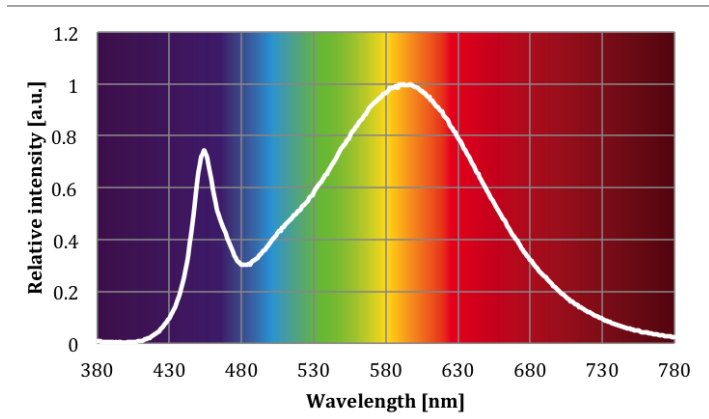

Fortimo LED SLM Gen 4 1100lm L13

Optical Characteristics – Table per CCT

Fortimo LED SLM 1100lm L13 840

Parameter	Min	Typ	Max	Unit
Luminous Flux	1190	1330	1470	lm
Module Efficiency		130		lm/W
Correlated Color Temperature		4000		K
Color Coordinates		(0.382, 0.380)		-
Color Consistency		3		SDCM
CRI		>80		-
Radiation Angle		115		deg
Thermal Power		6.6		W

Note: Specifications stated at Tc nom = 85°C and I nom = 300 mA

Parameter	Min	Typ	Max	Unit
Luminous Flux	1870	2080	2290	lm
Module Efficiency		116		lm/W
Thermal Power		12.5		W

Note: Specifications stated at Tc nom = 85°C and I = 500 mA

Ri	R1	R2	R3	R4	R5	R6	R7	R8	R9	R10	R11	R12	R13	R14	R15
81	79	90	96	76	78	84	85	63	7	74	72	58	82	98	73

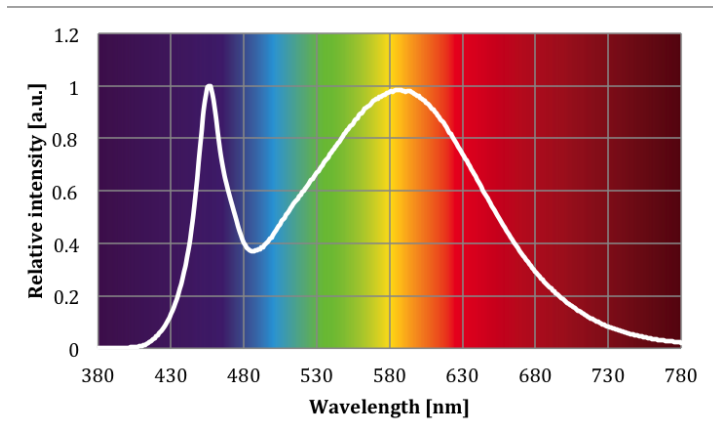

Fortimo LED SLM Gen 4 1100lm L13

Optical Characteristics – Table per CCT

Fortimo LED SLM 1100lm L13 927

Parameter	Min	Typ	Max	Unit
Luminous Flux	870	970	1070	lm
Module Efficiency		95		lm/W
Correlated Color Temperature		2700		K
Color Coordinates		(0.458, 0.410)		-
Color Consistency		3		SDCM
CRI		97		-
Radiation Angle		115		deg
Thermal Power		7.6		W

Note: Specifications stated at Tc nom = 85°C and I nom = 300 mA

Parameter	Min	Typ	Max	Unit
Luminous Flux	1360	1520	1680	lm
Module Efficiency		85		lm/W
Thermal Power		14.2		W

Note: Specifications stated at Tc nom = 85°C and I = 500 mA

Ri	R1	R2	R3	R4	R5	R6	R7	R8	R9	R10	R11	R12	R13	R14	R15
97	99	100	98	98	98	98	95	91	81	97	100	88	99	98	96

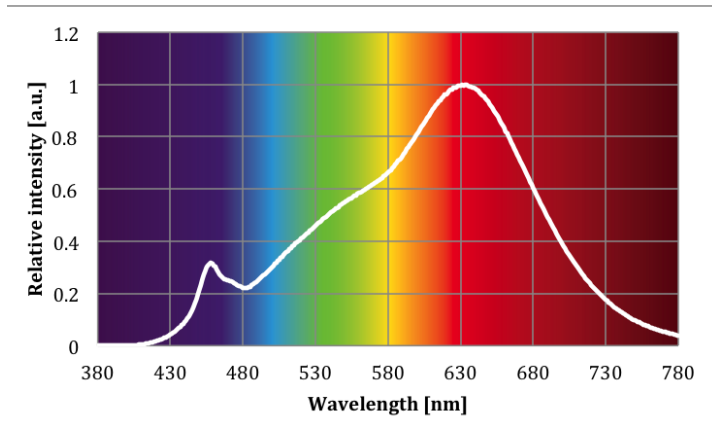

Fortimo LED SLM Gen 4 1100lm L13

Beam Shape

The Philips Fortimo LED SLM generates a Lambertian beam shape, which is a pragmatic starting point for OEMs wishing to design secondary optics.

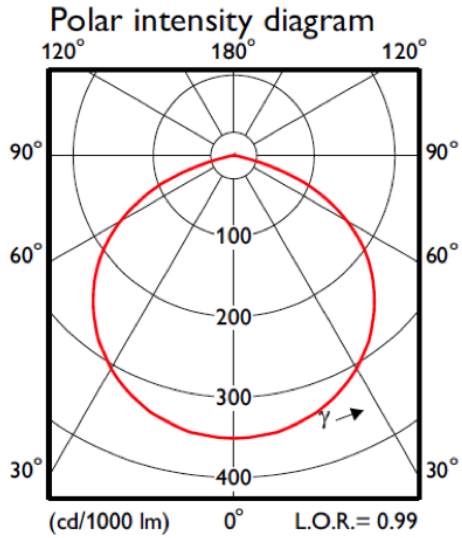

Electrical Characteristics

Parameter	Typ	Unit
Nominal Current	300	mA
Forward Voltage	33.9	V
Power Consumption	10.2	W

Note: Specifications stated at $T_c \text{ nom} = 85^\circ\text{C}$ and $I \text{ nom} = 300 \text{ mA}$

Parameter	Typ	Unit
Nominal Current	500	mA
Forward Voltage	35.9	V
Power Consumption	17.9	W

Note: Specifications stated at $T_c \text{ nom} = 85^\circ\text{C}$ and $I = 500 \text{ mA}$

Fortimo LED SLM Gen 4 1100lm L13

Lifetime

Parameter	Min	Typ	Max	Unit
Lumen Maintenance B50L70	50,000			hrs
$\Delta u/v'$ at 6000 Hours			0.0008	-
Critical Failures (10%)	50,000			hrs

Note: Specifications stated at $T_c \text{ nom} = 85^\circ\text{C}$ and $I \text{ nom} = 300 \text{ mA}$

Parameter	Nominal ²	Max ³
T_c ($^\circ\text{C}$)	85	95
Current (mA)	300	790

Note: $T_c \text{ life} \leq 85^\circ\text{C}$ (measured at 25°C ambient temperature)

Abs Max Ratings

Parameter	Min	Typ	Max	Unit
Current I_{max}			790	mA
Case Temperature $T_c \text{ Max}$			95	$^\circ\text{C}$
ESD Human Body Model (HBM) Class 3A JESD22-A114-E			8	kV
ESD Machine Model (MM) Class B JESD22-A115-B			400	kV
Operating Ambient Temperature	-20		40	$^\circ\text{C}$
Storage Temperature	-40		80	$^\circ\text{C}$

Mechanical Characteristics

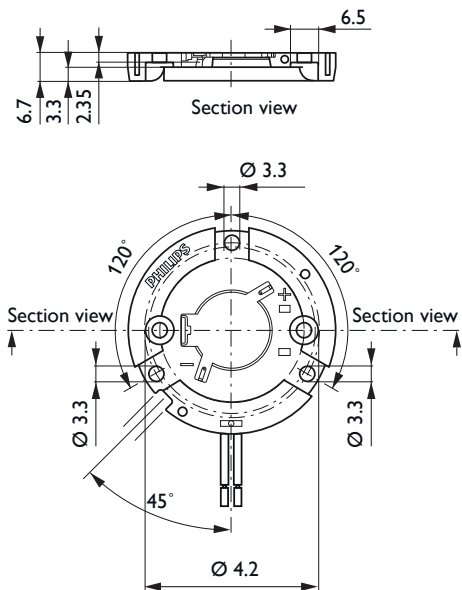

- Nominal value at which performance is specified.
- Maximum value for safety (at this temperature, warranty need not apply).

Fortimo LED SLM Gen 4 1100lm L13

Application information

Compliance and Approval

CSA/UL

Environmental

RoHS

Application Information

Zhaga*	1100lm L13 827	1100lm L13 830	1100lm L13 835	1100lm L13 840	1100lm L13 927
LES Diameter [mm]	13	13	13	13	13
Rotational Symmetry S	0.9	0.9	0.9	0.9	0.9
Uniformity Parameter U	100%	100%	100%	100%	100%
Correlated Color Temperature [K]	2700	3000	3500	4000	2700
Color Rendering Index	>80	>80	>80	>80	>90

* Measurements showing compliancy to Zhaga book 3 version 1.2 have been done on the 3000lm L15 module.

IP Rating	No IP rating
Overheating Protection	No protection

Fortimo LED SLM Gen 4 1100lm L13

Tuning Information

Flux and Efficacy Versus Current (at Nominal Temperature) 1100lm L13

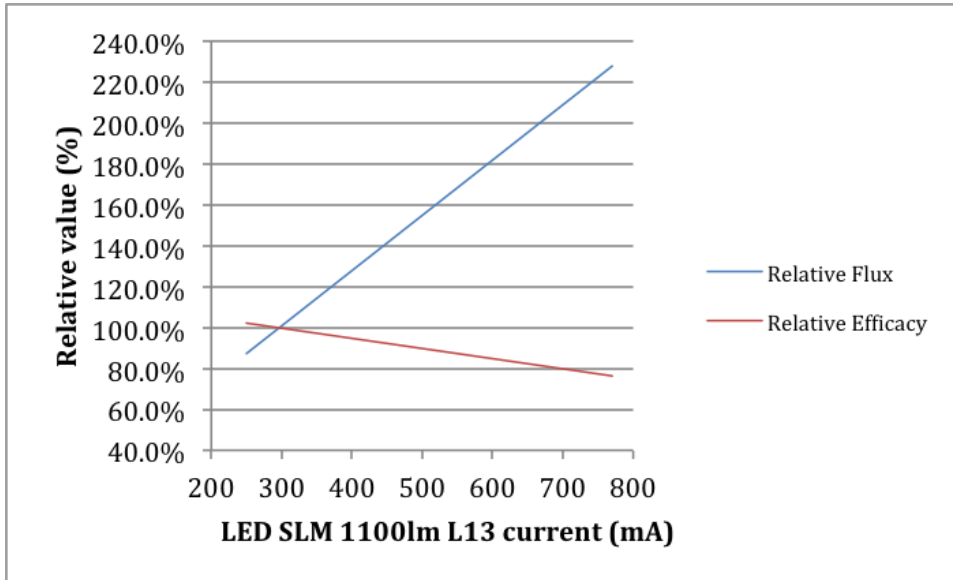

I [A]	Rel flux	Rel effic
250	84.9%	103.3%
270	90.9%	101.6%
292	97.8%	100.8%
300	100.0%	100.0%
323	107.0%	98.4%
368	120.2%	95.9%
387	125.5%	95.1%
436	139.5%	92.6%
485	152.9%	89.3%
500	156.8%	89.3%
536	166.6%	86.9%
602	183.1%	84.4%
669	200.4%	81.1%
724	214.0%	79.5%
750	220.1%	77.9%
770	227.3%	77.0%

Flux and Efficacy Versus Temperature at Tc (at Nominal Current) 1100lm L13

Tc (°C)	Flux (lm)	Efficacy (lm/W)
65	104.0%	103.2%
75	102.1%	101.6%
85	100.0%	100.0%

The highlighted current values are available as Rsets as a part of the system.

Please ensure that while tuning the product's operating point, it stays within limits of temperature (Tc) and current (I) that are covered within the warranty window.

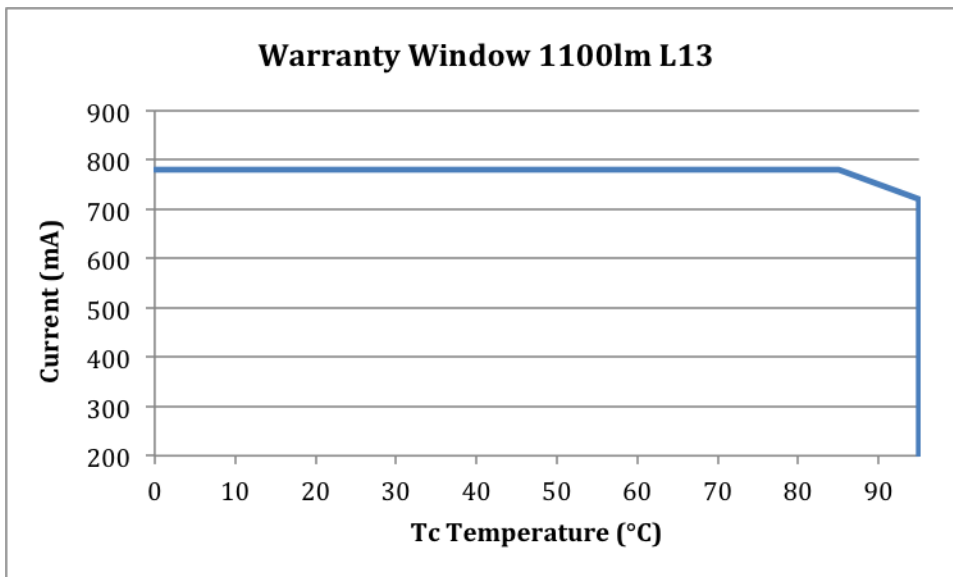

Fortimo LED SLM Gen 4 1100lm L13

Lumen Maintenance

Fortimo LED SLM 1100lm L13

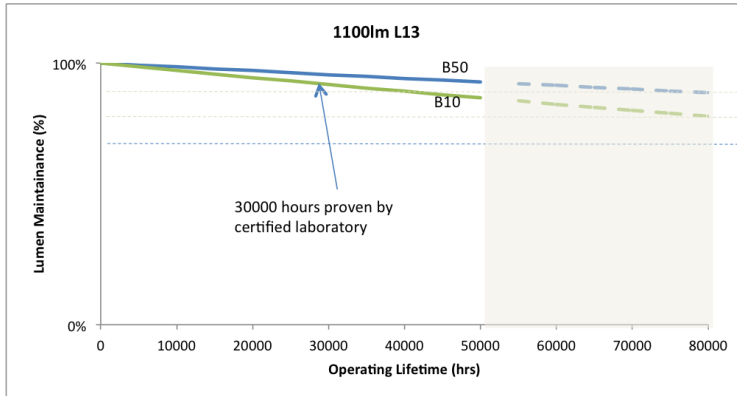

Lumen Maintenance (B50)

Fortimo LED SLM 1100lm L13

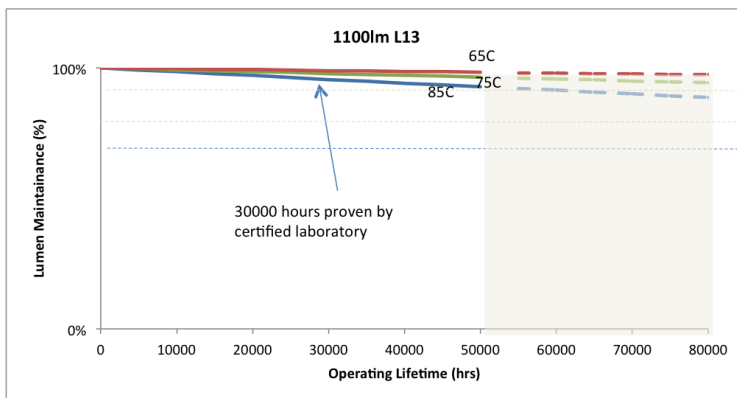

Measurements showing compliance to Zhaga book 3 version 1.2 have been done on the 3000lm L15 module.

© 2014 Koninklijke Philips N.V. All rights reserved.
Philips reserves the right to make changes in specifications and/or to discontinue any product at any time without notice or obligation and will not be liable for any consequences resulting from the use of this publication.
philips.com/leddrivers



Philips Lighting North America Corporation
10275 W. Higgins Road, Rosemont IL 60018
Tel: 800-322-2086 Fax: 888-423-1882
Customer/Technical Service: 800-372-3331
OEM Support: 866-915-5886

Imported by: Philips Lighting
A division of Philips Electronics Ltd.
281 Hillmount Rd, Markham, ON, Canada L6C 2S3
Tel. 800-668-9008