



# Philips Lighting Catalogue

**Binnenverlichting**  
Downlights

**PHILIPS**

# LuxSpace 2 Mini DN560B/DN561B/DN560C/DN561C

---



- Hoogste rendement over de hele reeks: tot 111 lm/W
- Creëert een zacht, natuurlijk licht en garandeert visueel comfort
- Perfecte integratie met plafond dankzij dunne, smalle sierrand; randloze uitvoering ideaal voor integratie in stucwerkplafonds

- De LuxSpace 2 biedt u de maximale energiebesparing in uw kantoor, winkel of hotel. Dit armatuur realiseert tot wel 60% energiebesparing in gangen, wachtruimtes, toiletten, entreehallen, werkplekken of verkeersruimtes.
- Tot wel 60% energiebesparing, de vervanger van 1 x 18 W, 2 x 18 W en 2 x 26 W PL-C downlights
- Versies:
  - Mini: DN560B/DN561B/DN560C/DN561C
  - Inbouw: DN560B/DN561B
  - Opbouw: DN560C/DN561C
  - Rimless: type RML voor stucwerkplafonds
- Optieken: Gefacetteerd (F), Hoogglans (C), Mat (M) of Witte (WR) reflector; DN561B voldoet aan de UGR19 (type F & C); DN560B voldoet aan de UGR22 (type F, C & M); Type WR voldoet aan de UGR25
- Lichtbron: LED
- Lichtstroom (Type C & F)  
DN560B:
  - LED8S: 820 lm (830/840)
  - LED12S: 940-1050-1200 lm (827-930-830/840)DN561B:
  - LED8S: 780 lm (830/840)
  - LED12S: 920-1050-1150 lm (827-930-830/840)
- Systemvermogen:
  - Zie online eCAT voor meest up to date systeem vermogens
- Levensduur: 50.000 uur (bij 80% lumenbehoud, bij Ta 25 °C, uitvals-percentage driver 1% per 5 K uur)
- Kleurtemperatuur: 827, 830, 840 & 930 – 2700 K, 3000 K of 4000 K
- Kleurweergave: > 80 & > 90
- Driver: externe LED driver standaard aangesloten meegeleverd; PSD driver dimbaar middels DALI; powerfactor > 0,9; Standaard goedgekeurd voor zowel 230Vac als 230VDC
- Lichtregeling: PSD driver dimbaar middels DALI; dimmen tot 1%; extra energiebesparing in combinatie met OccuSwitch DALI
- Elektrische aansluiting: standaard middels push-in connector, of CU3 connector voor doorvoerbedrading, CU5 connector voor doorvoerbedrading met DALI, overige connectoren en snoer op aanvraag mogelijk; Halogeen vrije kabels
- Montage: inbouw, gatmaat 150 mm (Mini) of 200 mm (Compact)
- Accessoires:
  - Rimless ring los bestellen (Mini: EOC 93776000)
  - IP54 versie in standaard glas (PG) of opaal glas (PGO)
- Opties:
  - Rim in standaard kleuren wit (WH, RAL9010), Grijs (GR, RAL9006), Zwart (BK, RAL 9005) of Hoogglans (CR). Overige RAL-kleuren verkrijgbaar (op aanvraag)
  - IP54 versie in standaard glas of opaal glas
  - Diverse voorzetglazen (mogelijk om voorgemonteerd te bestellen)
  - Geïntegreerde EL3 noodverlichting

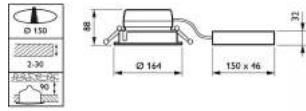

DN561

DB561B LED12S\_827 PSED-E C WH  
Afmetingen in mm.

## Bestelgegevens

| EOC | Type aanduiding                                | Typenummer       | MOQ | VRG code | Gewicht (KG) | Richtprijs |
|-----|--|------------------|-----|----------|--------------|------------|
| 4   | 93625100 DN560B LED12S/830 PSE-E C WH          | DN56B1283PECWH   | 1   | 89       | 1,01         | 157,50     |
| 4   | 93626800 DN560B LED12S/840 PSE-E C WH          | DN56B1284PECWH   | 1   | 89       | 1,01         | 157,50     |
| 4   | 93627500 DN560B LED12S/830 PSED-E C WH         | DN56B1283PDCWH   | 1   | 89       | 0,97         | 157,50     |
| 4   | 93628200 DN560B LED12S/840 PSED-E C WH         | DN56B1284PDCWH   | 1   | 89       | 0,97         | 157,50     |
| 4   | 93629900 DN560B LED12S/830 PSE-E F WH          | DN56B1283PEFWH   | 1   | 89       | 1,01         | 157,50     |
| 4   | 93630500 DN560B LED12S/840 PSE-E F WH          | DN56B1284PEFWH   | 1   | 89       | 1,01         | 157,50     |
| 4   | 93631200 DN560B LED12S/830 PSED-E F WH         | DN56B1283PDFWH   | 1   | 89       | 0,97         | 157,50     |
| 4   | 93632900 DN560B LED12S/840 PSED-E F WH         | DN56B1284PDFWH   | 1   | 89       | 0,97         | 157,50     |
| 4   | 93633600 DN560B LED12S/830 PSE-E M WH          | DN56B1283PEMWH   | 1   | 89       | 1,01         | 157,50     |
| Ⓞ   | 93635000 DN560B LED12S/830 PSE-E WR WH         | DN56B1283PWRWH   | 1   | 89       | 1,01         | 157,50     |
| Ⓞ   | 93637400 DN560B LED12S/830 PSE-E RML C CR      | DN56B1283PRCCR   | 1   | 89       | 0,89         | 157,50     |
| 4   | 93649700 DN560B LED12S/830 PSE-E C PG WH       | DN56B1283PCPGWH  | 1   | 89       | 1,11         | 175,50     |
| 4   | 93650300 DN560B LED12S/830 PSED-E C PG WH      | DN56B1283PDCPWH  | 1   | 89       | 1,07         | 175,50     |
| 4   | 93651000 DN560B LED12S/830 PSE-E F PG WH       | DN56B1283PFPGWH  | 1   | 89       | 1,11         | 175,50     |
| 4   | 93652700 DN560B LED12S/830 PSED-E F PG WH      | DN56B1283PDFPWH  | 1   | 89       | 1,07         | 175,50     |
| 4   | 93653400 DN560B LED12S/830 PSE-E C CU3 WH      | DN56B1283PCC3WH  | 1   | 89       | 1,06         | 162,00     |
| 4   | 93657200 DN560B LED12S/830 PSED-E C CU5 WH     | DN56B1283PDCC5W  | 1   | 89       | 1,02         | 162,00     |
| Ⓞ   | 93659600 DN560B LED12S/830 PSE-E C WH SG-O     | DN56B1283PCWSGO  | 1   | 89       | 1,17         | 202,50     |
| Ⓞ   | 93660200 DN560B LED12S/830 PSE-E C WH SG-FRC   | DN56B1283PCWSF   | 1   | 89       | 1,17         | 202,50     |
| Ⓞ   | 93661900 DN560B LED12S/830 PSE-E C WH SG-HR-FR | DN56B1283PCWSH   | 1   | 89       | 1,17         | 202,50     |
| 4   | 93662600 DN561B LED12S/830 PSE-E C WH          | DN561B1283PCWH   | 1   | 89       | 1,02         | 180,00     |
| 4   | 93663300 DN561B LED12S/840 PSE-E C WH          | DN561B1284PCWH   | 1   | 89       | 1,02         | 180,00     |
| 4   | 93664000 DN561B LED12S/830 PSED-E C WH         | DN561B1283PDCWH  | 1   | 89       | 0,98         | 180,00     |
| 4   | 93665700 DN561B LED12S/840 PSED-E C WH         | DN561B1284PDCWH  | 1   | 89       | 0,98         | 180,00     |
| 4   | 93666400 DN561B LED12S/830 PSE-E F WH          | DN561B1283PFWH   | 1   | 89       | 1,02         | 180,00     |
| 4   | 93667100 DN561B LED12S/840 PSE-E F WH          | DN561B1284PFWH   | 1   | 89       | 1,02         | 180,00     |
| 4   | 93668800 DN561B LED12S/830 PSED-E F WH         | DN561B1283PDFWH  | 1   | 89       | 0,98         | 180,00     |
| 4   | 93669500 DN561B LED12S/840 PSED-E F WH         | DN561B1284PDFWH  | 1   | 89       | 0,98         | 180,00     |
| 4   | 93670100 DN561B LED12S/830 PSE-E M WH          | DN561B1283PMWH   | 1   | 89       | 1,02         | 180,00     |
| Ⓞ   | 93672500 DN561B LED12S/830 PSE-E WR WH         | DN561B1283PWRWH  | 1   | 89       | 1,02         | 180,00     |
| 4   | 93686200 DN561B LED12S/830 PSE-E C PG WH       | DN561B1283PCPWH  | 1   | 89       | 1,12         | 198,00     |
| 4   | 93687900 DN561B LED12S/830 PSED-E C PG WH      | DN561B1283PDCPW  | 1   | 89       | 1,08         | 198,00     |
| 4   | 93688600 DN561B LED12S/830 PSE-E F PG WH       | DN561B1283PFPHWH | 1   | 89       | 1,12         | 198,00     |
| 4   | 93689300 DN561B LED12S/830 PSED-E F PG WH      | DN561B1283PDFPW  | 1   | 89       | 1,08         | 198,00     |
| 4   | 93760900 DN560B LED8S/830 PSE-E C WH           | DN56B883PECWH    | 1   | 89       | 1,01         | 148,50     |
| 4   | 93761600 DN560B LED8S/840 PSE-E C WH           | DN56B884PECWH    | 1   | 89       | 1,01         | 148,50     |
| 4   | 93762300 DN560B LED8S/830 PSED-E C WH          | DN56B883PDECWH   | 1   | 89       | 0,97         | 148,50     |
| 4   | 93763000 DN560B LED8S/840 PSED-E C WH          | DN56B884PDECWH   | 1   | 89       | 0,97         | 148,50     |
| 4   | 93764700 DN560B LED8S/830 PSE-E F WH           | DN56B883PEFWH    | 1   | 89       | 1,01         | 148,50     |
| 4   | 93765400 DN560B LED8S/840 PSE-E F WH           | DN56B884PEFWH    | 1   | 89       | 1,01         | 148,50     |
| 4   | 93766100 DN560B LED8S/830 PSED-E F WH          | DN56B883PDEFWH   | 1   | 89       | 0,97         | 148,50     |
| 4   | 93767800 DN560B LED8S/840 PSED-E F WH          | DN56B884PDEFWH   | 1   | 89       | 0,97         | 148,50     |
| 4   | 93768500 DN561B LED8S/830 PSE-E C WH           | DN561B883PECWH   | 1   | 89       | 1,02         | 171,00     |
| 4   | 93769200 DN561B LED8S/840 PSE-E C WH           | DN561B884PECWH   | 1   | 89       | 1,02         | 171,00     |
| 4   | 93770800 DN561B LED8S/830 PSED-E C WH          | DN561B883PDCWH   | 1   | 89       | 0,98         | 171,00     |
| 4   | 93771500 DN561B LED8S/840 PSED-E C WH          | DN561B884PDCWH   | 1   | 89       | 0,98         | 171,00     |
| 4   | 93772200 DN561B LED8S/830 PSE-E F WH           | DN561B883PEFWH   | 1   | 89       | 1,02         | 171,00     |
| 4   | 93773900 DN561B LED8S/840 PSE-E F WH           | DN561B884PEFWH   | 1   | 89       | 1,02         | 171,00     |
| 4   | 93774600 DN561B LED8S/830 PSED-E F WH          | DN561B883PDFWH   | 1   | 89       | 0,98         | 171,00     |
| 4   | 93775300 DN561B LED8S/840 PSED-E F WH          | DN561B884PDFWH   | 1   | 89       | 0,98         | 171,00     |
| 4   | 93776000 DN560Z CFRM-RML                       | DN56GCFRMRML     | 1   | 89       | 0,25         | 49,00      |
| 4   | 93777700 DN560G PG                             | DN56GPG          | 1   | 89       | 0,31         | 59,00      |
| Ⓞ   | 93778400 DN560G PGO                            | DN56GPGO         | 1   | 89       | 0,31         | 59,00      |
| 4   | 93782100 DN560B LED12S/827 PSE-E C WH          | DN56B12827PCWH   | 1   | 89       | 1,01         | 157,50     |
| 4   | 93783800 DN560B LED12S/930 PSE-E C WH          | DN56B12S93PECWH  | 1   | 89       | 1,01         | 157,50     |

# LuxSpace 2 Compact DN570B/DN571B/DN570C/DN571C

---



- Hoogste rendement over de hele reeks: tot 111 lm/W
- Creëert een zacht, natuurlijk licht en garandeert visueel comfort
- Perfecte integratie met plafond dankzij dunne, smalle sierrand; randloze uitvoering ideaal voor integratie in stucwerkplafonds

- De LuxSpace 2 biedt u de maximale energiebesparing in uw kantoor, winkel of hotel. Dit armatuur realiseert tot wel 60% energiebesparing in gangen, wachtruimtes, toiletten, entreehallen, werkplekken of verkeersruimtes.
- Tot wel 60% energiebesparing, de vervanger van 1 x 18 W, 2 x 18 W en 2 x 26 W PL-C downlights
- Versies:
  - Compact: DN570B/DN571B/DN570C/DN571C
  - Inbouw: DN570B/DN571B
  - Opbouw: DN570C/DN571C
  - Rimless: type RML voor stucwerkplafonds
- Optieken: Gefacetteerd (F), Hoogglans (C), Mat (M) of Witte (WR) reflector; DN571B voldoet aan de UGR19 (type F & C); DN570B voldoet aan de UGR22 (type F, C & M); Type WR voldoet aan de UGR25
- Lichtbron: LED
- Lichtstroom (Type C & F)  
DN570B:
  - LED12S: 1100-1200-1350 lm (827-930-830/840)
  - LED20S: 1750-1950-2200 lm (827-930-830/840)
  - LED24S: 2100-2400-2600 lm (827-930-830/840)DN571B:
  - LED12S: 1050-1150-1300 lm (827-930-830/840)
  - LED20S: 1700-1900-2100 lm (827-930-830/840)
  - LED24S: 2000-2300-2500 lm (827-930-830/840)
- Systemvermogen:
  - Zie online eCAT voor meest up to date systeem vermogens
- Levensduur: 50.000 uur (bij 80% lumenbehoud, bij Ta 25 °C, uitvals-percentage driver 1% per 5 K uur)
- Kleurtemperatuur: 827, 830, 840 & 930 – 2700 K, 3000 K of 4000 K
- Kleurweergave: > 80 & > 90
- Driver: externe LED driver standaard aangesloten meegeleverd; PSD driver dimbaar middels DALI; powerfactor > 0,9; Standaard goedgekeurd voor zowel 230Vac als 230VDC
- Lichtregeling: PSD driver dimbaar middels DALI; dimmen tot 1%; extra energiebesparing in combinatie met OccuSwitch DALI
- Elektrische aansluiting: standaard middels push-in connector, of CU3 connector voor doorvoerbedrading, CU5 connector voor doorvoerbedrading met DALI, overige connectoren en snoer op aanvraag mogelijk; Halogeen vrije kabels
- Montage: inbouw, gatmaat 150 mm (Mini) of 200 mm (Compact)
- Accessoires:
  - Rimless ring los bestellen (Compact: EOC 93236900)
  - IP54 versie in standaard glas (PG) of opaal glas (PGO)
- Opties:
  - Rim in standaard kleuren wit (WH, RAL9010), Grijs (GR, RAL9006), Zwart (BK, RAL 9005) of Hoogglans (CR). Overige RAL-kleuren verkrijgbaar (op aanvraag)
  - IP54 versie in standaard glas of opaal glas
  - Diverse voorzetglazen (mogelijk om voorgemonteerd te bestellen)
  - Geïntegreerde EL3 noodverlichting

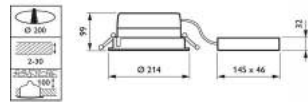

DN570

DN570B LED12S\_830 PSED-E C WH  
Afmetingen in mm.

## Bestelgegevens

| EOC | Type aanduiding                        | Typenummer      | MOQ | VRG code | Gewicht (KG) | Richtprijs |
|-----|--|-----------------|-----|----------|--------------|------------|
| 3   | 93042600 DN570B LED12S/830 PSED-E C WH | DN570B12S83DWHC | 1   | 89       | 1,48         | 157,50     |
| 4   | 93046400 DN570B LED12S/830 PSED-E F WH | DN570B12S83DWHF | 1   | 89       | 1,48         | 157,50     |
| 4   | 93040200 DN570B LED12S/830 PSE-E C WH  | DN570B12S830WHC | 1   | 89       | 1,55         | 157,50     |
| 4   | 93044000 DN570B LED12S/830 PSE-E F WH  | DN570B12S830WHF | 1   | 89       | 1,55         | 157,50     |
| 3   | 93043300 DN570B LED12S/840 PSED-E C WH | DN570B12S84DWHC | 1   | 89       | 1,48         | 157,50     |
| 4   | 93047100 DN570B LED12S/840 PSED-E F WH | DN570B12S84DWHF | 1   | 89       | 1,48         | 157,50     |
| 4   | 93041900 DN570B LED12S/840 PSE-E C WH  | DN570B12S840WHC | 1   | 89       | 1,55         | 157,50     |
| 4   | 93045700 DN570B LED12S/840 PSE-E F WH  | DN570B12S840WHF | 1   | 89       | 1,55         | 157,50     |
| 4   | 93054900 DN570B LED20S/830 PSED-E C WH | DN570B20S83DWHC | 1   | 89       | 1,48         | 180,00     |
| 4   | 93058700 DN570B LED20S/830 PSED-E F WH | DN570B20S83DWHF | 1   | 89       | 1,48         | 180,00     |
| 3   | 93052500 DN570B LED20S/830 PSE-E C WH  | DN570B20S830WHC | 1   | 89       | 1,55         | 180,00     |
| 4   | 93056300 DN570B LED20S/830 PSE-E F WH  | DN570B20S830WHF | 1   | 89       | 1,55         | 180,00     |
| 4   | 93055600 DN570B LED20S/840 PSED-E C WH | DN570B20S84DWHC | 1   | 89       | 1,48         | 180,00     |
| 4   | 93059400 DN570B LED20S/840 PSED-E F WH | DN570B20S84DWHF | 1   | 89       | 1,48         | 180,00     |
| 4   | 93053200 DN570B LED20S/840 PSE-E C WH  | DN570B20S840WHC | 1   | 89       | 1,55         | 180,00     |
| 4   | 93057000 DN570B LED20S/840 PSE-E F WH  | DN570B20S840WHF | 1   | 89       | 1,55         | 180,00     |
| 4   | 93082200 DN570B LED24S/830 PSED-E C WH | DN570B24S83DWHC | 1   | 89       | 1,48         | 207,00     |
| 4   | 93086000 DN570B LED24S/830 PSED-E F WH | DN570B24S83DWHF | 1   | 89       | 1,48         | 207,00     |
| 4   | 93080800 DN570B LED24S/830 PSE-E C WH  | DN570B24S830WHC | 1   | 89       | 1,55         | 207,00     |
| 4   | 93084600 DN570B LED24S/830 PSE-E F WH  | DN570B24S830WHF | 1   | 89       | 1,55         | 207,00     |
| 4   | 93083900 DN570B LED24S/840 PSED-E C WH | DN570B24S84DWHC | 1   | 89       | 1,48         | 207,00     |
| 4   | 93087700 DN570B LED24S/840 PSED-E F WH | DN570B24S84DWHF | 1   | 89       | 1,48         | 207,00     |
| 4   | 93081500 DN570B LED24S/840 PSE-E C WH  | DN570B24S840WHC | 1   | 89       | 1,55         | 207,00     |
| 4   | 93085300 DN570B LED24S/840 PSE-E F WH  | DN570B24S840WHF | 1   | 89       | 1,55         | 207,00     |
| 4   | 94390700 DN570B LED38S/TWH PSED-E C WH | DN570B38TWPSDCW | 1   | 89       |              | 427,50     |
| 4   | 94126200 DN570B LED40S/830 PSED-E F WH | DN570B483PDFWH  | 1   | 89       |              | 234,00     |
| 4   | 94127900 DN570B LED40S/840 PSED-E F WH | DN570B484PDFWH  | 1   | 89       |              | 234,00     |
| 4   | 94353200 DN570B LED24S/830 POE C WH    | DN570POEME      | 1   | 89       |              | 341,10     |
| 4   | 94354900 DN570B LED24S/840 POE C WH    | DN570BJOSJE2    | 1   | 89       |              | 341,10     |
| 4   | 93236900 DN570G CFRM-RML               | DN570GCFRMRML   | 1   | 89       | 0,31         | 49,00      |
| 4   | 93234500 DN570G PG                     | DN570GPG        | 1   | 89       | 0,36         | 59,00      |
| 4   | 93235200 DN570G PGO                    | DN570GPGO       | 1   | 89       | 0,37         | 59,00      |
| 4   | 93107200 DN571B LED12S/830 PSED-E C WH | DN571B12S83DWHC | 1   | 89       | 1,48         | 180,00     |
| 4   | 93111900 DN571B LED12S/830 PSED-E F WH | DN571B12S83DWHF | 1   | 89       | 1,48         | 180,00     |
| 4   | 93105800 DN571B LED12S/830 PSE-E C WH  | DN571B12S830WHC | 1   | 89       | 1,55         | 180,00     |
| 4   | 93109600 DN571B LED12S/830 PSE-E F WH  | DN571B12S830WHF | 1   | 89       | 1,55         | 180,00     |
| 4   | 93108900 DN571B LED12S/840 PSED-E C WH | DN571B12S84DWHC | 1   | 89       | 1,48         | 180,00     |
| 4   | 93112600 DN571B LED12S/840 PSED-E F WH | DN571B12S84DWHF | 1   | 89       | 1,48         | 180,00     |
| 4   | 93106500 DN571B LED12S/840 PSE-E C WH  | DN571B12S840WHC | 1   | 89       | 1,55         | 180,00     |
| 4   | 93110200 DN571B LED12S/840 PSE-E F WH  | DN571B12S840WHF | 1   | 89       | 1,55         | 180,00     |
| 4   | 93119500 DN571B LED20S/830 PSED-E C WH | DN571B20S83DWHC | 1   | 89       | 1,48         | 202,50     |
| 4   | 93123200 DN571B LED20S/830 PSED-E F WH | DN571B20S83DWHF | 1   | 89       | 1,48         | 202,50     |
| 3   | 93117100 DN571B LED20S/830 PSE-E C WH  | DN571B20S830WHC | 1   | 89       | 1,55         | 202,50     |
| 4   | 93121800 DN571B LED20S/830 PSE-E F WH  | DN571B20S830WHF | 1   | 89       | 1,55         | 202,50     |

| EOC | Type aanduiding                             | Typenummer      | MOQ | VRG code | Gewicht (KG) | Richtprijs |
|-----|---|-----------------|-----|----------|--------------|------------|
| 4   | 93120100 DN571B LED20S/840 PSED-E C WH      | DN571B20S84DWHC | 1   | 89       | 1,48         | 202,50     |
| 4   | 93124900 DN571B LED20S/840 PSED-E F WH      | DN571B20S84DWHF | 1   | 89       | 1,48         | 202,50     |
| 4   | 93118800 DN571B LED20S/840 PSE-E C WH       | DN571B20S840WHC | 1   | 89       | 1,55         | 202,50     |
| 4   | 93122500 DN571B LED20S/840 PSE-E F WH       | DN571B20S840WHF | 1   | 89       | 1,55         | 202,50     |
| 4   | 93147800 DN571B LED24S/830 PSED-E C WH      | DN571B24S83DWHC | 1   | 89       | 1,48         | 229,50     |
| 4   | 93151500 DN571B LED24S/830 PSED-E F WH      | DN571B24S83DWHF | 1   | 89       | 1,48         | 229,50     |
| 4   | 93145400 DN571B LED24S/830 PSE-E C WH       | DN571B24S830WHC | 1   | 89       | 1,55         | 229,50     |
| 4   | 93149200 DN571B LED24S/830 PSE-E F WH       | DN571B24S830WHF | 1   | 89       | 1,55         | 229,50     |
| 4   | 93148500 DN571B LED24S/840 PSED-E C WH      | DN571B24S84DWHC | 1   | 89       | 1,48         | 229,50     |
| 4   | 93152200 DN571B LED24S/840 PSED-E F WH      | DN571B24S84DWHF | 1   | 89       | 1,48         | 229,50     |
| 4   | 93146100 DN571B LED24S/840 PSE-E C WH       | DN571B24S840WHC | 1   | 89       | 1,55         | 229,50     |
| 4   | 93150800 DN571B LED24S/840 PSE-E F WH       | DN571B24S840WHF | 1   | 89       | 1,55         | 229,50     |
| ©   | 94391400 DN571B LED38S/TWH PSED-E C WH      | DN571B38TWPSDCW | 1   | 89       |              | 427,50     |
| 4   | 94134700 DN571B LED40S/830 PSED-E F WH      | DN571B483PDFWH  | 1   | 89       |              | 256,50     |
| 4   | 94135400 DN571B LED40S/840 PSED-E F WH      | DN571B484PDFWH  | 1   | 89       |              | 256,50     |
| ©   | 94481200 DN570C LED20S/830 PSED-E C D250 WH | DN570C283PDCD2W | 1   | 89       |              | 247,50     |
| ©   | 94483600 DN570C LED24S/830 PSED-E C D250 WH | DN570C2483PDC2W | 1   | 89       |              | 274,50     |
| ©   | 94485000 DN570C LED40S/830 PSED-E C D250 WH | DN570C4083PDC2W | 1   | 89       |              | 301,50     |
| ©   | 94487400 DN570C LED20S/840 PSED-E C D250 WH | DN570C284PDCD2W | 1   | 89       |              | 247,50     |
| ©   | 94489800 DN570C LED24S/840 PSED-E C D250 WH | DN570C2484PDC2W | 1   | 89       |              | 274,50     |
| ©   | 94491100 DN570C LED40S/840 PSED-E C D250 WH | DN570C4084PDC2W | 1   | 89       |              | 301,50     |

# LuxSpace 2 Vierkant - DN572B



- Hoogste rendement over de hele reeks
- Creëert een zacht, natuurlijk licht en garandeert visueel comfort
- Perfecte integratie met plafond dankzij dunne, smalle sierrand; randloze uitvoering ideaal voor integratie in stucwerkplafonds

- De LuxSpace 2 biedt u de maximale energiebesparing in uw kantoor, winkel of hotel. Dit armatuur realiseert tot wel 60% energiebesparing in gangen, wachtruimtes, toiletten, entreehallen, werkplekken of verkeersruimtes.
- Tot wel 60% energiebesparing, de vervanger van 1x18 W, 2x18 W en 2x26 W PL-C downlights
- Versies:
  - Compact Vierkant: DN572B
  - Rimless: type RML voor stucwerkplafonds
- Optieken: gefacetteerde (F), hoogglans (C), matte (M) of witte (WR) reflector
- Lichtbron: LED
- Systeemvermogen:
  - Zie online Ecat voor de meest up to date systeem vermogens
- Levensduur: 50.000 uur (bij 80% lumenbehoud, bij Ta 25 °C, uitvalpercentage driver 1% per 5.000 uur)
- Kleurtemperatuur: 827, 830, 840 & 930 – 2700 K, 3000 K of 4000 K
- Kleurweergave: > 80 & > 90
- Driver: externe LED driver standaard aangesloten meegeleverd; PSD driver dimbaar middels DALI; powerfactor > 0,9; Standaard goedgekeurd voor zowel 230 Vac als 230 VDC
- Lichtregeling: PSD driver dimbaar middels DALI; dimmen tot 1%; extra energiebesparing in combinatie met OccuSwitch DALI
- Elektrische aansluiting: standaard middels push-in connector, of CU3 connector voor doorvoerbedrading, CU5 connector voor doorvoerbedrading met DALI, overige connectoren en snoer op aanvraag mogelijk; halogeen vrije kabels
- Montage: inbouw, gatmaat 200 mm (Compact)
- Accessoires:
  - Rimless ring apart bestellen (DN572 CFRM-RML: 93966500)
- Opties:
  - Rim in standaard kleuren wit (WH, RAL9010), grijs (GR, RAL9006), zwart (BK, RAL 9004) of hoogglans (CR). Overige RAL-kleuren verkrijgbaar op aanvraag.
  - Geïntegreerde EL3 noodverlichting

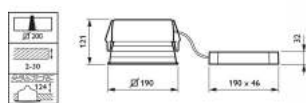

DN572B (inbouw)

DN572B Afmetingen in mm.



## Bestelgegevens

| EOC | Type aanduiding                            | Typenummer      | MOQ | VRG code | Gewicht (KG) | Richtprijs |
|-----|--|-----------------|-----|----------|--------------|------------|
| 4   | 94019700 DN572B LED12S/830 PSED-E C WH     | DN572B1283DCWH  | 1   | 89       | 1,91         | 202,50     |
| 4   | 94020300 DN572B LED12S/840 PSED-E C WH     | DN572B12840DCWH | 1   | 89       | 1,91         | 202,50     |
| 4   | 94023400 DN572B LED12S/830 PSED-E F WH     | DN572B1283DFWH  | 1   | 89       | 1,91         | 202,50     |
| 4   | 94024100 DN572B LED12S/840 PSED-E F WH     | DN572B12840DFWH | 1   | 89       | 1,91         | 202,50     |
| 4   | 94027200 DN572B LED20S/830 PSED-E C WH     | DN572B2083DCWH  | 1   | 89       | 1,91         | 225,00     |
| 4   | 94028900 DN572B LED20S/840 PSED-E C WH     | DN572B20840DCWH | 1   | 89       | 1,91         | 225,00     |
| 4   | 94031900 DN572B LED20S/830 PSED-E F WH     | DN572B2083DFWH  | 1   | 89       | 1,91         | 225,00     |
| 4   | 94032600 DN572B LED20S/840 PSED-E F WH     | DN572B20840DFWH | 1   | 89       | 1,91         | 225,00     |
| ©   | 94038800 DN572B LED20S/830 PSED-E RML C CR | DN572B2083DRLCR | 1   | 89       | 1,52         | 225,00     |
| ©   | 94040100 DN572B LED20S/830 PSED-E RML F CR | DN572B2083DRFCR | 1   | 89       | 1,52         | 225,00     |
| 4   | 94055500 DN572B LED24S/830 PSED-E C WH     | DN572B2483DCWH  | 1   | 89       | 1,91         | 252,00     |
| 4   | 94056200 DN572B LED24S/840 PSED-E C WH     | DN572B24840DCWH | 1   | 89       | 1,91         | 252,00     |
| 4   | 94059300 DN572B LED24S/830 PSED-E F WH     | DN572B2483DFWH  | 1   | 89       | 1,91         | 252,00     |
| 4   | 94060900 DN572B LED24S/840 PSED-E F WH     | DN572B24840DFWH | 1   | 89       | 1,91         | 252,00     |
| ©   | 94366200 DN572B LED24S/840 POE C WH        | DN572B001       | 1   | 89       |              | 270,00     |
| 4   | 93966500 DN572Z CFRM-RML                   | DN572CFRMRML    | 1   | 89       |              | 49,00      |

# LuxSpace Accent vast RS730B/RS740B/RS750B



- Zeer hoge lichtopbrengst voor uiterst krachtige accenten
- Uitstekende lichtkwaliteit
- Bespaart aanzienlijk op energie- en onderhoudskosten



De LuxSpace Accent is een uiterst krachtige LED spot welke zeer geschikt is voor accentverlichting in retail omgevingen. Door de zeer hoge lichtopbrengst kan de LuxSpace Accent zeer krachtige accenten creëren.

- Alternatief voor 50 W halogeen, 20 W, 35 W, 50 W tot 70 W CDM spots
- Versies: inbouw vast (RS730B/RS740B/RS750B)
- Optieken: NB, MB, WB, VWB of OVL
- Lichtbron: LED
- Levensduur: 50.000 uur (80% lumenbehoud bij Ta 25 °C)
- Kleurtemperatuur: 2700 K, 3000 K of 4000 K
- Kleurweergave: Ra > 80 of Ra > 90 (alleen bij 3000 K)
- Driver: externe driver aangesloten meegeleverd
- Lichtregeling: DALI dimbaar
- Elektrische aansluiting: push-in connector
- Materiaal: koelblok, reflector en behuizing van aluminium, bevestigingsmechanisme van staal en polycarbonaat, driver, accessoires en optiekhouders van kunststof, behuizing in wit (WH), zwart (BK) of grijs (GR)
- Montage: inbouw
- Opties:
  - RAL-kleuren verkrijgbaar (op aanvraag)
- Accessoires:
  - middelbrede, brede en extra brede bundeloptieken
  - ovale optiek





RS730B WH

## Bestelgegevens

| EOC | Type aanduiding                         | Typenummer       | MOQ | VRG code | Gewicht (KG) | Richtprijs |
|-----|---|------------------|-----|----------|--------------|------------|
| [4] | 84761900 RS730B LED12S/830 PSE-E WB WH  | RS730B1283PWBWH  | 1   | 89       | 0,71         | 152,10     |
| [4] | 84762600 RS730B LED12S/830 PSED-E WB WH | RS730B1283DWBWH  | 1   | 89       | 0,71         | 179,10     |
| [4] | 84767100 RS730B LED12S/840 PSE-E WB WH  | RS730B1284PWBWH  | 1   | 89       | 0,71         | 152,10     |
| [4] | 84768800 RS730B LED12S/840 PSED-E WB WH | RS730B1284DWBWH  | 1   | 89       | 0,71         | 179,10     |
| [5] | 84765700 RS730B LED12S/930 PSE-E MB WH  | RS730B1293PMBWH  | 1   | 89       | 0,71         | 152,10     |
| [5] | 97309700 RS740B LED20S/PW9 PSED-E NB WH | RS740B20PWNDNBWH | 1   | 89       |              | 206,10     |

# LuxSpace Accent

## Bestelinformatie

| Armatuur   | Versie   | LED Module   | Kleur-temperatuur  | Lumen pakket   | Bundel   | Kleur  | Driver   | Kabel & Connector  |  |
|--|--|--|--|--|--|--|--|--|--|
| <input type="checkbox"/> MINI<br>                                 | <input type="checkbox"/> Vast RS730B<br><br><input type="checkbox"/> Richtbaar RS731B  | <input type="checkbox"/> LED11S (NB)               | <input type="checkbox"/> 830<br><input type="checkbox"/> 930<br><input type="checkbox"/> 827<br><input type="checkbox"/> 840                                 | <input type="checkbox"/> 1000 lm<br><input type="checkbox"/> 960 lm<br><input type="checkbox"/> 1050 lm<br><input type="checkbox"/> 1000 lm                                      | <input type="checkbox"/> NB = 11D  | <input type="checkbox"/> WH (RAL 9003)<br><br><input type="checkbox"/> BK (RAL9004)<br><br><input type="checkbox"/> SI (RAL9006)<br><br><input type="checkbox"/> ALU <i>alleen voor Fix Mini</i> | <input type="checkbox"/> PSU<br><br><br><input type="checkbox"/> PSD                                     | <input type="checkbox"/> Push-in (PI)<br><br><input type="checkbox"/> Wieland/ Adels compatible connector met kabel lengte van 0.5 m (CW)<br><br><input type="checkbox"/> Mogelijkheid voor doorvoerbedrading (CU3 of CUS) |  |
|  |  | <input type="checkbox"/> LED14S (NB)               | <input type="checkbox"/> CRW   | <input type="checkbox"/> 1200 lm   | <input type="checkbox"/> NB = 11D  |  |  |  |  |
|  |  | <input type="checkbox"/> LED12S (MB, WB)           | <input type="checkbox"/> 830<br><input type="checkbox"/> 930<br><input type="checkbox"/> 827<br><input type="checkbox"/> 840<br><input type="checkbox"/> CRW | <input type="checkbox"/> 1250 lm<br><input type="checkbox"/> 1200 lm<br><input type="checkbox"/> 1150 lm<br><input type="checkbox"/> 1300 lm<br><input type="checkbox"/> 1150 lm | <input type="checkbox"/> MB = 27D<br><input type="checkbox"/> WB = 36D   |  |  |  |  |
| <input type="checkbox"/> COMPACT<br>                              | <input type="checkbox"/> Vast RS740B   | <input type="checkbox"/> LED20S (NB)               | <input type="checkbox"/> 830<br><input type="checkbox"/> 930<br><input type="checkbox"/> 827<br><input type="checkbox"/> 840<br><input type="checkbox"/> CRW | <input type="checkbox"/> 2000 lm<br><input type="checkbox"/> 1650 lm<br><input type="checkbox"/> 1900 lm<br><input type="checkbox"/> 2200 lm<br><input type="checkbox"/> 1250 lm | <input type="checkbox"/> NB = 10D  | <input type="checkbox"/> WH (RAL 9003)<br><br><input type="checkbox"/> BK (RAL9004)  | <input type="checkbox"/> PSU<br><br><input type="checkbox"/> PSD   |  |  |
|  |  | <input type="checkbox"/> LED17S (MB, WB, LIN)      | <input type="checkbox"/> 830<br><input type="checkbox"/> 930<br><input type="checkbox"/> 827<br><input type="checkbox"/> 840<br><input type="checkbox"/> CRW | <input type="checkbox"/> 1700 lm<br><input type="checkbox"/> 1750 lm<br><input type="checkbox"/> 1600 lm<br><input type="checkbox"/> 1800 lm<br><input type="checkbox"/> 1700 lm | <input type="checkbox"/> MB = 24D<br><input type="checkbox"/> WB = 33D<br><input type="checkbox"/> MB-LIN = 40D x 36D<br><input type="checkbox"/> WB-LIN = 42D x 36D                                       |  |  |  |  |
|  |  | <input type="checkbox"/> LED17S (MB, WB, LIN)      | <input type="checkbox"/> CH  | <input type="checkbox"/> 1900 lm   | <input type="checkbox"/> MB = 27D<br><input type="checkbox"/> WB = 36D<br><input type="checkbox"/> MB-LIN = 41D x 28D<br><input type="checkbox"/> WB-LIN = 53D x 33D                                       |  |  |  | <input type="checkbox"/> SI (RAL9006)                        |
|  | <input type="checkbox"/> Richtbaar RS741B  | <input type="checkbox"/> LED19S (MB, WB, LIN)      | <input type="checkbox"/> FMT   | <input type="checkbox"/> 2100 lm   | <input type="checkbox"/> MB = 27D<br><input type="checkbox"/> WB = 36D<br><input type="checkbox"/> MB-LIN = 41D x 28D<br><input type="checkbox"/> WB-LIN = 53D x 33D                                       |  | <input type="checkbox"/> ALU voor Fix<br><br><input type="checkbox"/> ALU-BK voor Cardanic (ALU-RAL9004) |  | <input type="checkbox"/> PSU                                 |
|  |  | <input type="checkbox"/> LED27S (MB, WB, LIN)      | <input type="checkbox"/> 830<br><input type="checkbox"/> 930<br><input type="checkbox"/> 827<br><input type="checkbox"/> 840<br><input type="checkbox"/> CRW | <input type="checkbox"/> 2700 lm<br><input type="checkbox"/> 2700 lm<br><input type="checkbox"/> 2500 lm<br><input type="checkbox"/> 2900 lm<br><input type="checkbox"/> 2700 lm | <input type="checkbox"/> MB = 29D<br><input type="checkbox"/> WB = 35D<br><input type="checkbox"/> MB-LIN = 40D x 36D<br><input type="checkbox"/> WB-LIN = 42D x 36D                                       |  | <input type="checkbox"/> ALU-WH voor Cardanic (ALU-RAL9003)  |  | <input type="checkbox"/> PSU<br><input type="checkbox"/> PSD |
|  |  | <input type="checkbox"/> LED39S (MB, WB, LIN)      | <input type="checkbox"/> 830<br><input type="checkbox"/> 930<br><input type="checkbox"/> 827<br><input type="checkbox"/> 840                                 | <input type="checkbox"/> 3900 lm<br><input type="checkbox"/> 3200 lm<br><input type="checkbox"/> 3600 lm<br><input type="checkbox"/> 4100 lm                                     | <input type="checkbox"/> MB = 29D<br><input type="checkbox"/> WB = 35D<br><input type="checkbox"/> MB-LIN = 40D x 36D<br><input type="checkbox"/> WB-LIN = 42D x 36D                                       |  |  |  | <input type="checkbox"/> PSD                                 |
| <input type="checkbox"/> PERFORMANCE (* Update 1 Juli 2015)<br> | <input type="checkbox"/> Elbow RS752B  | <input type="checkbox"/> LED27S (MB, WB, LIN)      | <input type="checkbox"/> 830<br><input type="checkbox"/> 930<br><input type="checkbox"/> 827<br><input type="checkbox"/> 840<br><input type="checkbox"/> CRW | <input type="checkbox"/> 2700 lm<br><input type="checkbox"/> 2700 lm<br><input type="checkbox"/> 2500 lm<br><input type="checkbox"/> 2900 lm<br><input type="checkbox"/> 2700 lm |  |  |  |  |  |
|  | <input type="checkbox"/> Vast RS750B   | <input type="checkbox"/> LED40S (NB)               | <input type="checkbox"/> 830<br><input type="checkbox"/> 930<br><input type="checkbox"/> 827<br><input type="checkbox"/> 840                                 | <input type="checkbox"/> 4100 lm<br><input type="checkbox"/> 3600 lm<br><input type="checkbox"/> 3800 lm<br><input type="checkbox"/> 4400 lm                                     |  |  |  |  |  |
|  |  | <input type="checkbox"/> LED26S (NB)               | <input type="checkbox"/> CRW   | <input type="checkbox"/> 2300 lm   |  |  |  |  |  |
|  |  | <input type="checkbox"/> LED27S (MB, WB, VWB, LIN) | <input type="checkbox"/> CH  | <input type="checkbox"/> 3100 lm   | <input type="checkbox"/> MB = 21D<br><input type="checkbox"/> WB = 30D<br><input type="checkbox"/> VWB = 53D<br><input type="checkbox"/> MB-LIN = 48D x 22D<br><input type="checkbox"/> WB-LIN = 51D x 29D |  |  |  |  |
|  | <input type="checkbox"/> Richtbaar RS751B<br><br><input type="checkbox"/> Elbow RS752B | <input type="checkbox"/> LED26S (MB, WB, VWB, LIN) | <input type="checkbox"/> FMT   | <input type="checkbox"/> 3000 lm   | <input type="checkbox"/> MB = 21D<br><input type="checkbox"/> WB = 30D<br><input type="checkbox"/> VWB = 53D<br><input type="checkbox"/> MB-LIN = 48D x 22D<br><input type="checkbox"/> WB-LIN = 51D x 29D |  |  |  |  |
|  |  | <input type="checkbox"/> LED39S (MB, WB, VWB, LIN) | <input type="checkbox"/> 830<br><input type="checkbox"/> 930<br><input type="checkbox"/> 827<br><input type="checkbox"/> 840<br><input type="checkbox"/> CRW | <input type="checkbox"/> 3900 lm<br><input type="checkbox"/> 3900 lm<br><input type="checkbox"/> 3600 lm<br><input type="checkbox"/> 4200 lm<br><input type="checkbox"/> 3800 lm |  |  |  |  |  |
|  |  | <input type="checkbox"/> LED49S (MB, WB, VWB, LIN) | <input type="checkbox"/> 830<br><input type="checkbox"/> 930<br><input type="checkbox"/> 827<br><input type="checkbox"/> 840                                 | <input type="checkbox"/> 4900 lm<br><input type="checkbox"/> 4500 lm<br><input type="checkbox"/> 4500 lm<br><input type="checkbox"/> 5200 lm                                     |  |  |  |  |  |
|  |  |  |  |  |  |  |  |  |  |

# LuxSpace Accent richtbaar RS731B/RS741B/RS751B



- Zeer hoge lichtopbrengst voor uiterst krachtige accenten
- Uitstekende lichtkwaliteit
- Bespaart aanzienlijk op energie- en onderhoudskosten



De LuxSpace Accent is een uiterst krachtige LED spot welke zeer geschikt is voor accentverlichting in retail omgevingen. Door de zeer hoge lichtopbrengst kan de LuxSpace Accent zeer krachtige accenten creëren.

- Alternatief voor 50 W halogeen, 20 W, 35 W, 50 W tot 70 W CDM spots
- Versies: inbouw vast (RS731B/RS741B/RS751B)
- Optieken: NB, MB, WB, VWB of OVL
- Lichtbron: LED
- Levensduur: 50.000 uur (80% lumenbehoud bij Ta 25 °C)
- Kleurtemperatuur: 2700 K, 3000 K of 4000 K
- Kleurweergave: Ra > 80 of Ra > 90 (alleen bij 3000 K)
- Driver: externe driver aangesloten meegeleverd
- Lichtregeling: DALI dimbaar
- Elektrische aansluiting: push-in connector
- Materiaal: koelblok, reflector en behuizing van aluminium, bevestigingsmechanisme van staal en polycarbonaat, driver, accessoires en optiekhouders van kunststof, behuizing in wit (WH), zwart (BK) of grijs (GR)
- Montage: inbouw
- Opties:
  - RAL-kleuren verkrijgbaar (op aanvraag)
- Accessoires:
  - middelbrede, brede en extra brede bundeloptieken
  - ovale optiek



RS751B WH





RS751B GR

## Bestelgegevens

| EOC | Type aanduiding | Typenummer                         | MOQ              | VRG code | Gewicht (KG) | Richtprijs |
|-----|-----------------|------------------------------------|------------------|----------|--------------|------------|
| 5   | 84759600        | RS731B LED11S/930 PSE-E NB WH      | RS731B1193PNBWH  | 1        | 89 0,71      | 170,10     |
| 5   | 84760200        | RS731B LED12S/827 PSE-E MB WH      | RS731B12827MBWH  | 1        | 89 0,71      | 170,10     |
| 4   | 84763300        | RS731B LED12S/830 PSE-E WB WH      | RS731B1283PWBWH  | 1        | 89 0,71      | 170,10     |
| 4   | 84770100        | RS731B LED12S/840 PSED-E WB WH     | RS731B1284DWBWH  | 1        | 89 0,71      | 197,10     |
| 4   | 84769500        | RS731B LED12S/840 PSE-E WB WH      | RS731B1284PWBWH  | 1        | 89 0,71      | 170,10     |
| 5   | 84766400        | RS731B LED12S/930 PSE-E MB WH      | RS731B1293PMBWH  | 1        | 89 0,71      | 170,10     |
| 5   | 26378500        | RS741B LED15S/CRW PSE-E NB WH      | RS741B15CRWNBWH  | 1        | 89 0,94      | 197,10     |
| 5   | 84809800        | RS741B LED17S/827 PSE-E MB WH      | RS741B1782EMBWH  | 1        | 89 0,94      | 197,10     |
| 4   | 84811100        | RS741B LED17S/830 PSE-E WB WH      | RS741B1783PWBWH  | 1        | 89 0,94      | 197,10     |
| 5   | 84813500        | RS741B LED17S/840 PSE-E WB WH      | RS741B1784PWBWH  | 1        | 89 0,94      | 197,10     |
| 5   | 84815900        | RS741B LED17S/930 PSE-E MB WH      | RS741B1793PMBWH  | 1        | 89 0,94      | 197,10     |
| 5   | 26379200        | RS741B LED17S/CRW PSE-E MB WH      | RS741B17CRWMBWH  | 1        | 89 0,94      | 197,10     |
| 5   | 26380800        | RS741B LED17S/CRW PSE-E WB WH      | RS741B17CRWWBWH  | 1        | 89 0,94      | 197,10     |
| 5   | 84808100        | RS741B LED20S/930 PSE-E NB WH      | RS741B2093PNBWH  | 1        | 89 0,94      | 197,10     |
| 5   | 84810400        | RS741B LED27S/827 PSE-E MB WH      | RS741B2782EMBWH  | 1        | 89 0,94      | 224,10     |
| 5   | 84817300        | RS741B LED27S/827 PSE-E WB WH LIN  | RS741B27827WWHL  | 1        | 89 0,94      | 224,10     |
| 4   | 84812800        | RS741B LED27S/830 PSE-E WB WH      | RS741B2783PWBWH  | 1        | 89 0,94      | 224,10     |
| 5   | 84814200        | RS741B LED27S/840 PSE-E WB WH      | RS741B2784PWBWH  | 1        | 89 0,94      | 224,10     |
| 5   | 84816600        | RS741B LED27S/930 PSE-E MB WH      | RS741B2793PMBWH  | 1        | 89 0,94      | 224,10     |
| 5   | 26381500        | RS741B LED27S/CRW PSE-E MB WH      | RS741B27CRWMBWH  | 1        | 89 0,94      | 224,10     |
| 5   | 26382200        | RS741B LED27S/CRW PSE-E WB WH      | RS741B27CRWWBWH  | 1        | 89 0,94      | 224,10     |
| 5   | 84772500        | RS741B LED39S/830 PSE-E WB WH      | RS741B3983PWBWH  | 1        | 89 0,94      | 251,10     |
| 5   | 84773200        | RS741B LED39S/840 PSE-E WB WH      | RS741B3984PWBWH  | 1        | 89 0,94      | 251,10     |
| 4   | 84779400        | RS751B LED39S/830 PSE-E WB WH      | RS751B3983PEWBW  | 1        | 89 1,81      | 251,10     |
| 4   | 84781700        | RS751B LED39S/930 PSE-E MB WH      | RS751B3993PEMBW  | 1        | 89 1,81      | 251,10     |
| 4   | 84783100        | RS751B LED39S/840 PSE-E VWB WH     | RS751B3984PEVWW  | 1        | 89 1,81      | 251,10     |
| 4   | 84785500        | RS751B LED39S/827 PSE-E WB WH LIN  | RS751B3982PWBWL  | 1        | 89 1,81      | 251,10     |
| 5   | 97317200        | RS741B LED20S/PW9 PSED-E NB WH     | RS741B20PWDBNBWH | 1        | 89           | 215,10     |
| 5   | 16708000        | RS751B LED27S/CH PSE-E WB WH LIN   | RS751B27CHPWBWL  | 1        | 89           | 278,10     |
| 5   | 16709700        | RS751B LED26S/FMT PSED-E WB WH LIN | RS751B26SFPDWWL  | 1        | 89           | 314,10     |
| 5   | 16710300        | RS751B LED39S/CRW PSE-E MB WH      | RS751B39SCPMBW   | 1        | 89           | 251,10     |
| 5   | 16711000        | RS751B LED39S/CRW PSE-E WB WH      | RS751B39SCPWBW   | 1        | 89           | 251,10     |
| 4   | 16712700        | RS752B LED27S/CRW PSE-E MB WH      | RS752B27SCPMBW   | 1        | 89           | 233,10     |
| 4   | 16713400        | RS752B LED27S/CRW PSE-E WB WH      | RS752B27SCPWBW   | 1        | 89           | 233,10     |
| 4   | 16714100        | RS752B LED39S/CRW PSE-E MB WH      | RS752B39SCPMBW   | 1        | 89           | 260,10     |
| 4   | 16715800        | RS752B LED39S/CRW PSE-E WB WH      | RS752B39SCPWBW   | 1        | 89           | 260,10     |
| 5   | 16716500        | RS751B LED40S/930 PSE-E NB WH      | RS751B40S93PNBW  | 1        | 89           | 251,10     |
| 5   | 16718900        | RS751B LED49S/827 PSE-E MB WH      | RS751B49827PMBW  | 1        | 89           | 278,10     |
| 5   | 16720200        | RS751B LED49S/830 PSE-E WB WH      | RS751B49S83PWBW  | 1        | 89           | 278,10     |
| 5   | 16722600        | RS751B LED49S/930 PSE-E MB WH      | RS751B49S93PMBW  | 1        | 89           | 278,10     |
| 5   | 16724000        | RS751B LED49S/840 PSE-E VWB WH     | RS751B4984PVWBW  | 1        | 89           | 278,10     |
| 5   | 16726400        | RS751B LED49S/827 PSE-E WB WH LIN  | RS751B49827PWWL  | 1        | 89           | 278,10     |
| 4   | 16729500        | RS752B LED49S/830 PSE-E WB WH      | RS752B49S83PWBW  | 1        | 89           | 287,10     |
| 4   | 16730100        | RS752B LED49S/830 PSED-E WB WH     | RS752B4983PDWBW  | 1        | 89           | 314,10     |
| 4   | 16732500        | RS752B LED49S/827 PSE-E MB WH      | RS752B49827PMBW  | 1        | 89           | 287,10     |
| 4   | 16735600        | RS752B LED49S/930 PSE-E MB WH      | RS752B49S93PMBW  | 1        | 89           | 287,10     |
| 4   | 16736300        | RS752B LED49S/930 PSED-E MB WH     | RS752B4993PDMBW  | 1        | 89           | 314,10     |
| 4   | 16739400        | RS752B LED49S/840 PSE-E VWB WH     | RS752B4984PVWBW  | 1        | 89           | 287,10     |
| 4   | 16740000        | RS752B LED49S/840 PSED-E VWB WH    | RS752B4984PDVBW  | 1        | 89           | 314,10     |
| 4   | 16743100        | RS752B LED49S/827 PSE-E WB WH LIN  | RS752B4982PWWL   | 1        | 89           | 287,10     |
| 4   | 16744800        | RS752B LED49S/827 PSED-E WB WH LIN | RS752B4982PDWWL  | 1        | 89           | 314,10     |
| 5   | 16745500        | RS751B LED19S/ROSE PSE-E WB WH     | RS751B19SRPWBW   | 1        | 89           | 305,10     |
| 5   | 16746200        | RS751B LED19S/ROSE PSE-E VWB WH    | RS751B19SRPVWBW  | 1        | 89           | 305,10     |
| 5   | 16747900        | RS751B LED19S/ROSE PSE-E WB WH LIN | RS751B19RPWBWL   | 1        | 89           | 305,10     |
| 5   | 16748600        | RS751B LED26S/ROSE PSE-E WB WH     | RS751B26SRPWBW   | 1        | 89           | 332,10     |
| 4   | 16749300        | RS752B LED19S/ROSE PSE-E WB WH     | RS752B19SRPWBW   | 1        | 89           | 314,10     |
| 4   | 16750900        | RS752B LED26S/ROSE PSE-E WB WH     | RS752B26SRPWBW   | 1        | 89           | 341,10     |
| 4   | 16751600        | RS752B LED26S/ROSE PSE-E VWB WH    | RS752B26SRPVWBW  | 1        | 89           | 341,10     |

# LuxSpace Accent

## Bestelinformatie

| Armatuur   | Versie  | LED Module   | Kleur-temperatuur  | Lumen pakket   | Bundel   | Kleur  | Driver   | Kabel & Connector  |  |
|--|---|--|--|--|--|--|--|--|--|
| <input type="checkbox"/> MINI<br>                                 | <input type="checkbox"/> Vast RS730B<br><br><input type="checkbox"/> Richtbaar RS731B | <input type="checkbox"/> LED11S (NB)               | <input type="checkbox"/> 830<br><input type="checkbox"/> 930<br><input type="checkbox"/> 827<br><input type="checkbox"/> 840                                 | <input type="checkbox"/> 1000 lm<br><input type="checkbox"/> 960 lm<br><input type="checkbox"/> 1050 lm<br><input type="checkbox"/> 1000 lm                                      | <input type="checkbox"/> NB = 11D  | <input type="checkbox"/> WH (RAL 9003)<br><br><input type="checkbox"/> BK (RAL9004)<br><br><input type="checkbox"/> SI (RAL9006)<br><br><input type="checkbox"/> ALU <i>alleen voor Fix Mini</i> | <input type="checkbox"/> PSU<br><br><br><input type="checkbox"/> PSD   | <input type="checkbox"/> Push-in (PI)<br><br><input type="checkbox"/> Wieland/ Adels compatible connector met kabel lengte van 0.5 m (CW)<br><br><input type="checkbox"/> Mogelijkheid voor doorvoerbedrading (CU3 of CUS) |  |
|  |   | <input type="checkbox"/> LED14S (NB)               | <input type="checkbox"/> CRW   | <input type="checkbox"/> 1200 lm   | <input type="checkbox"/> NB = 11D  |  |  |  |  |
|  |   | <input type="checkbox"/> LED12S (MB, WB)           | <input type="checkbox"/> 830<br><input type="checkbox"/> 930<br><input type="checkbox"/> 827<br><input type="checkbox"/> 840<br><input type="checkbox"/> CRW | <input type="checkbox"/> 1250 lm<br><input type="checkbox"/> 1200 lm<br><input type="checkbox"/> 1150 lm<br><input type="checkbox"/> 1300 lm<br><input type="checkbox"/> 1150 lm | <input type="checkbox"/> MB = 27D<br><input type="checkbox"/> WB = 36D   |  |  |  |  |
| <input type="checkbox"/> COMPACT<br>                              | <input type="checkbox"/> Vast RS740B<br><br><input type="checkbox"/> Richtbaar RS741B | <input type="checkbox"/> LED20S (NB)               | <input type="checkbox"/> 830<br><input type="checkbox"/> 930<br><input type="checkbox"/> 827<br><input type="checkbox"/> 840<br><input type="checkbox"/> CRW | <input type="checkbox"/> 2000 lm<br><input type="checkbox"/> 1650 lm<br><input type="checkbox"/> 1900 lm<br><input type="checkbox"/> 2200 lm<br><input type="checkbox"/> 1250 lm | <input type="checkbox"/> NB = 10D  | <input type="checkbox"/> WH (RAL 9003)<br><br><input type="checkbox"/> BK (RAL9004)<br><br><input type="checkbox"/> SI (RAL9006)   | <input type="checkbox"/> PSU<br><br><input type="checkbox"/> PSD<br><br><input type="checkbox"/> PSU<br><input type="checkbox"/> PSD |  |  |
|  |   | <input type="checkbox"/> LED17S (MB, WB, LIN)      | <input type="checkbox"/> 830<br><input type="checkbox"/> 930<br><input type="checkbox"/> 827<br><input type="checkbox"/> 840<br><input type="checkbox"/> CRW | <input type="checkbox"/> 1700 lm<br><input type="checkbox"/> 1750 lm<br><input type="checkbox"/> 1600 lm<br><input type="checkbox"/> 1800 lm<br><input type="checkbox"/> 1700 lm | <input type="checkbox"/> MB = 24D<br><input type="checkbox"/> WB = 33D<br><input type="checkbox"/> MB-LIN = 40D x 36D<br><input type="checkbox"/> WB-LIN = 42D x 36D                                       |  |  |  |  |
|  |   | <input type="checkbox"/> LED17S (MB, WB, LIN)      | <input type="checkbox"/> CH  | <input type="checkbox"/> 1900 lm   | <input type="checkbox"/> MB = 27D<br><input type="checkbox"/> WB = 36D<br><input type="checkbox"/> MB-LIN = 41D x 28D<br><input type="checkbox"/> WB-LIN = 53D x 33D                                       |  |  |  |  |
|  |   | <input type="checkbox"/> LED19S (MB, WB, LIN)      | <input type="checkbox"/> FMT   | <input type="checkbox"/> 2100 lm   | <input type="checkbox"/> MB = 27D<br><input type="checkbox"/> WB = 36D<br><input type="checkbox"/> MB-LIN = 41D x 28D<br><input type="checkbox"/> WB-LIN = 53D x 33D                                       | <input type="checkbox"/> ALU voor Fix<br><br><input type="checkbox"/> ALU-BK voor Cardanic (ALU-RAL9004)<br><br><input type="checkbox"/> ALU-WH voor Cardanic (ALU-RAL9003)                      | <input type="checkbox"/> PSU<br><br><input type="checkbox"/> PSD   |  |  |
|  |   | <input type="checkbox"/> LED27S (MB, WB, LIN)      | <input type="checkbox"/> 830<br><input type="checkbox"/> 930<br><input type="checkbox"/> 827<br><input type="checkbox"/> 840<br><input type="checkbox"/> CRW | <input type="checkbox"/> 2700 lm<br><input type="checkbox"/> 2700 lm<br><input type="checkbox"/> 2500 lm<br><input type="checkbox"/> 2900 lm<br><input type="checkbox"/> 2700 lm | <input type="checkbox"/> MB = 29D<br><input type="checkbox"/> WB = 35D<br><input type="checkbox"/> MB-LIN = 40D x 36D<br><input type="checkbox"/> WB-LIN = 42D x 36D                                       |  |  |  |  |
|  |   | <input type="checkbox"/> LED39S (MB, WB, LIN)      | <input type="checkbox"/> 830<br><input type="checkbox"/> 930<br><input type="checkbox"/> 827<br><input type="checkbox"/> 840                                 | <input type="checkbox"/> 3900 lm<br><input type="checkbox"/> 3200 lm<br><input type="checkbox"/> 3600 lm<br><input type="checkbox"/> 4100 lm                                     | <input type="checkbox"/> MB = 29D<br><input type="checkbox"/> WB = 35D<br><input type="checkbox"/> MB-LIN = 40D x 36D<br><input type="checkbox"/> WB-LIN = 42D x 36D                                       |  |  |  |  |
| <input type="checkbox"/> PERFORMANCE (* Update 1 Juli 2015)<br> | <input type="checkbox"/> Elbow RS752B   | <input type="checkbox"/> LED27S (MB, WB, LIN)      | <input type="checkbox"/> 830<br><input type="checkbox"/> 930<br><input type="checkbox"/> 827<br><input type="checkbox"/> 840<br><input type="checkbox"/> CRW | <input type="checkbox"/> 2700 lm<br><input type="checkbox"/> 2700 lm<br><input type="checkbox"/> 2500 lm<br><input type="checkbox"/> 2900 lm<br><input type="checkbox"/> 2700 lm |  |  |  |  |  |
|  | <input type="checkbox"/> Vast RS750B  | <input type="checkbox"/> LED40S (NB)               | <input type="checkbox"/> 830<br><input type="checkbox"/> 930<br><input type="checkbox"/> 827<br><input type="checkbox"/> 840                                 | <input type="checkbox"/> 4100 lm<br><input type="checkbox"/> 3600 lm<br><input type="checkbox"/> 3800 lm<br><input type="checkbox"/> 4400 lm                                     |  |  |  |  |  |
|  |   | <input type="checkbox"/> LED26S (NB)               | <input type="checkbox"/> CRW   | <input type="checkbox"/> 2300 lm   |  |  |  |  |  |
|  |   | <input type="checkbox"/> LED27S (MB, WB, VWB, LIN) | <input type="checkbox"/> CH  | <input type="checkbox"/> 3100 lm   | <input type="checkbox"/> MB = 21D<br><input type="checkbox"/> WB = 30D<br><input type="checkbox"/> VWB = 53D<br><input type="checkbox"/> MB-LIN = 48D x 22D<br><input type="checkbox"/> WB-LIN = 51D x 29D |  |  |  |  |
|  | <input type="checkbox"/> Elbow RS752B   | <input type="checkbox"/> LED26S (MB, WB, VWB, LIN) | <input type="checkbox"/> FMT   | <input type="checkbox"/> 3000 lm   | <input type="checkbox"/> MB = 21D<br><input type="checkbox"/> WB = 30D<br><input type="checkbox"/> VWB = 53D<br><input type="checkbox"/> MB-LIN = 48D x 22D<br><input type="checkbox"/> WB-LIN = 51D x 29D |  |  |  |  |
|  |   | <input type="checkbox"/> LED39S (MB, WB, VWB, LIN) | <input type="checkbox"/> 830<br><input type="checkbox"/> 930<br><input type="checkbox"/> 827<br><input type="checkbox"/> 840<br><input type="checkbox"/> CRW | <input type="checkbox"/> 3900 lm<br><input type="checkbox"/> 3900 lm<br><input type="checkbox"/> 3600 lm<br><input type="checkbox"/> 4200 lm<br><input type="checkbox"/> 3800 lm |  |  |  |  |  |
|  |   | <input type="checkbox"/> LED49S (MB, WB, VWB, LIN) | <input type="checkbox"/> 830<br><input type="checkbox"/> 930<br><input type="checkbox"/> 827<br><input type="checkbox"/> 840                                 | <input type="checkbox"/> 4900 lm<br><input type="checkbox"/> 4500 lm<br><input type="checkbox"/> 4500 lm<br><input type="checkbox"/> 5200 lm                                     |  |  |  |  |  |

# LuxSpace Accent elbow RS752B



- Zeer hoge lichtopbrengst voor uiterst krachtige accenten
- Uitstekende lichtkwaliteit
- Bespaart aanzienlijk op energie- en onderhoudskosten

De LuxSpace Accent is een uiterst krachtige LED spot welke zeer geschikt is voor accentverlichting in retail omgevingen. Door de zeer hoge lichtopbrengst kan de LuxSpace Accent zeer krachtige accenten creëren.

- Alternatief voor 50 W halogeen, 20 W, 35 W, 50 W tot 70 W CDM spots
- Versies: inbouw richtbaar/elleboog
- Optieken: NB, MB, WB, VWB of OVL
- Lichtbron: LED
- Levensduur: 50.000 uur (80% lumenbehoud bij Ta 25 °C)
- Kleurtemperatuur: 2700 K, 3000 K of 4000 K
- Kleurweergave: Ra > 80 of Ra > 90 (alleen bij 3000 K)
- Driver: externe driver aangesloten meegeleverd
- Lichtregeling: DALI dimbaar
- Elektrische aansluiting: push-in connector
- Materiaal: koelblok, reflector en behuizing van aluminium, bevestigingsmechanisme van staal en polycarbonaat, driver, accessoires en optiekhouders van kunststof, behuizing in wit (WH), zwart (BK) of grijs (GR)
- Montage: inbouw
- Opties:
  - RAL-kleuren verkrijgbaar (op aanvraag)
- Accessoires:
  - middelbrede, brede en extra brede bundeloptieken
  - ovale optiek



RS752B WH





RS752B BK

## Bestelgegevens

| EOC | Type aanduiding                            | Typenummer      | MOQ | VRG code | Gewicht (KG) | Richtprijs |
|-----|--|-----------------|-----|----------|--------------|------------|
| 4   | 84787900 RS752B LED27S/830 PSE-E WB WH     | RS752B2783PEWBW | 1   | 89       | 1,81         | 260,10     |
| 4   | 84788600 RS752B LED39S/830 PSE-E WB WH     | RS752B3983PEWBW | 1   | 89       | 1,81         | 260,10     |
| 4   | 84794700 RS752B LED39S/930 PSE-E MB WH     | RS752B3993PEMBW | 1   | 89       | 1,81         | 260,10     |
| 4   | 84798500 RS752B LED39S/840 PSE-E VWB WH    | RS752B3984PEVWW | 1   | 89       | 1,81         | 260,10     |
| 5   | 84801200 RS752B LED27S/827 PSE-E WB WH LIN | RS752B2782PWBWL | 1   | 89       | 1,81         | 260,10     |

# LuxSpace Accent

## Bestelinformatie

| Armatuur   | Versie   | LED Module   | Kleur-temperatuur  | Lumen pakket   | Bundel   | Kleur  | Driver   | Kabel & Connector  |  |
|--|--|--|--|--|--|--|--|--|--|
| <input type="checkbox"/> MINI<br>                                 | <input type="checkbox"/> Vast RS730B<br><br><input type="checkbox"/> Richtbaar RS731B  | <input type="checkbox"/> LED11S (NB)               | <input type="checkbox"/> 830<br><input type="checkbox"/> 930<br><input type="checkbox"/> 827<br><input type="checkbox"/> 840                                 | <input type="checkbox"/> 1000 lm<br><input type="checkbox"/> 960 lm<br><input type="checkbox"/> 1050 lm<br><input type="checkbox"/> 1000 lm                                      | <input type="checkbox"/> NB = 11D  | <input type="checkbox"/> WH (RAL 9003)<br><br><input type="checkbox"/> BK (RAL9004)<br><br><input type="checkbox"/> SI (RAL9006)<br><br><input type="checkbox"/> ALU <i>alleen voor Fix Mini</i> | <input type="checkbox"/> PSU<br><br><br><input type="checkbox"/> PSD                                     |  |  |
|  |  | <input type="checkbox"/> LED14S (NB)               | <input type="checkbox"/> CRW   | <input type="checkbox"/> 1200 lm   | <input type="checkbox"/> NB = 11D  |  |  |  |  |
|  |  | <input type="checkbox"/> LED12S (MB, WB)           | <input type="checkbox"/> 830<br><input type="checkbox"/> 930<br><input type="checkbox"/> 827<br><input type="checkbox"/> 840<br><input type="checkbox"/> CRW | <input type="checkbox"/> 1250 lm<br><input type="checkbox"/> 1200 lm<br><input type="checkbox"/> 1150 lm<br><input type="checkbox"/> 1300 lm<br><input type="checkbox"/> 1150 lm | <input type="checkbox"/> MB = 27D<br><input type="checkbox"/> WB = 36D   |  |  |  |  |
| <input type="checkbox"/> COMPACT<br>                              | <input type="checkbox"/> Vast RS740B   | <input type="checkbox"/> LED20S (NB)               | <input type="checkbox"/> 830<br><input type="checkbox"/> 930<br><input type="checkbox"/> 827<br><input type="checkbox"/> 840<br><input type="checkbox"/> CRW | <input type="checkbox"/> 2000 lm<br><input type="checkbox"/> 1650 lm<br><input type="checkbox"/> 1900 lm<br><input type="checkbox"/> 2200 lm<br><input type="checkbox"/> 1250 lm | <input type="checkbox"/> NB = 10D  | <input type="checkbox"/> WH (RAL 9003)<br><br><input type="checkbox"/> BK (RAL9004)  | <input type="checkbox"/> PSU<br><br><input type="checkbox"/> PSD   | <input type="checkbox"/> Push-in (PI)<br><br><input type="checkbox"/> Wieland/ Adels compatible connector met kabel lengte van 0.5 m (CW)<br><br><input type="checkbox"/> Mogelijkheid voor doorvoerbedrading (CU3 of CUS) |  |
|  |  | <input type="checkbox"/> LED17S (MB, WB, LIN)      | <input type="checkbox"/> 830<br><input type="checkbox"/> 930<br><input type="checkbox"/> 827<br><input type="checkbox"/> 840<br><input type="checkbox"/> CRW | <input type="checkbox"/> 1700 lm<br><input type="checkbox"/> 1750 lm<br><input type="checkbox"/> 1600 lm<br><input type="checkbox"/> 1800 lm<br><input type="checkbox"/> 1700 lm | <input type="checkbox"/> MB = 24D<br><input type="checkbox"/> WB = 33D<br><input type="checkbox"/> MB-LIN = 40D x 36D<br><input type="checkbox"/> WB-LIN = 42D x 36D                                       |  | <input type="checkbox"/> WH (RAL 9003)<br><br><input type="checkbox"/> BK (RAL9004)                      |  | <input type="checkbox"/> PSU<br><br><input type="checkbox"/> PSD |
|  |  | <input type="checkbox"/> LED17S (MB, WB, LIN)      | <input type="checkbox"/> CH  | <input type="checkbox"/> 1900 lm   | <input type="checkbox"/> MB = 27D<br><input type="checkbox"/> WB = 36D<br><input type="checkbox"/> MB-LIN = 41D x 28D<br><input type="checkbox"/> WB-LIN = 53D x 33D                                       |  | <input type="checkbox"/> SI (RAL9006)  |  | <input type="checkbox"/> PSU<br><br><input type="checkbox"/> PSD |
|  | <input type="checkbox"/> Richtbaar RS741B  | <input type="checkbox"/> LED19S (MB, WB, LIN)      | <input type="checkbox"/> FMT   | <input type="checkbox"/> 2100 lm   | <input type="checkbox"/> MB = 27D<br><input type="checkbox"/> WB = 36D<br><input type="checkbox"/> MB-LIN = 41D x 28D<br><input type="checkbox"/> WB-LIN = 53D x 33D                                       |  | <input type="checkbox"/> ALU voor Fix<br><br><input type="checkbox"/> ALU-BK voor Cardanic (ALU-RAL9004) |  | <input type="checkbox"/> PSU<br><br><input type="checkbox"/> PSD |
|  |  | <input type="checkbox"/> LED27S (MB, WB, LIN)      | <input type="checkbox"/> 830<br><input type="checkbox"/> 930<br><input type="checkbox"/> 827<br><input type="checkbox"/> 840<br><input type="checkbox"/> CRW | <input type="checkbox"/> 2700 lm<br><input type="checkbox"/> 2700 lm<br><input type="checkbox"/> 2500 lm<br><input type="checkbox"/> 2900 lm<br><input type="checkbox"/> 2700 lm | <input type="checkbox"/> MB = 29D<br><input type="checkbox"/> WB = 35D<br><input type="checkbox"/> MB-LIN = 40D x 36D<br><input type="checkbox"/> WB-LIN = 42D x 36D                                       |  | <input type="checkbox"/> ALU-WH voor Cardanic (ALU-RAL9003)  |  | <input type="checkbox"/> PSU<br><br><input type="checkbox"/> PSD |
|  |  | <input type="checkbox"/> LED39S (MB, WB, LIN)      | <input type="checkbox"/> 830<br><input type="checkbox"/> 930<br><input type="checkbox"/> 827<br><input type="checkbox"/> 840                                 | <input type="checkbox"/> 3900 lm<br><input type="checkbox"/> 3200 lm<br><input type="checkbox"/> 3600 lm<br><input type="checkbox"/> 4100 lm                                     | <input type="checkbox"/> MB = 29D<br><input type="checkbox"/> WB = 35D<br><input type="checkbox"/> MB-LIN = 40D x 36D<br><input type="checkbox"/> WB-LIN = 42D x 36D                                       |  |  |  | <input type="checkbox"/> PSD                                     |
| <input type="checkbox"/> PERFORMANCE (* Update 1 Juli 2015)<br> | <input type="checkbox"/> Elbow RS752B  | <input type="checkbox"/> LED27S (MB, WB, LIN)      | <input type="checkbox"/> 830<br><input type="checkbox"/> 930<br><input type="checkbox"/> 827<br><input type="checkbox"/> 840<br><input type="checkbox"/> CRW | <input type="checkbox"/> 2700 lm<br><input type="checkbox"/> 2700 lm<br><input type="checkbox"/> 2500 lm<br><input type="checkbox"/> 2900 lm<br><input type="checkbox"/> 2700 lm |  |  |  |  |  |
|  | <input type="checkbox"/> Vast RS750B   | <input type="checkbox"/> LED40S (NB)               | <input type="checkbox"/> 830<br><input type="checkbox"/> 930<br><input type="checkbox"/> 827<br><input type="checkbox"/> 840                                 | <input type="checkbox"/> 4100 lm<br><input type="checkbox"/> 3600 lm<br><input type="checkbox"/> 3800 lm<br><input type="checkbox"/> 4400 lm                                     |  |  |  |  |  |
|  |  | <input type="checkbox"/> LED26S (NB)               | <input type="checkbox"/> CRW   | <input type="checkbox"/> 2300 lm   |  |  |  |  |  |
|  |  | <input type="checkbox"/> LED27S (MB, WB, VWB, LIN) | <input type="checkbox"/> CH  | <input type="checkbox"/> 3100 lm   | <input type="checkbox"/> MB = 21D<br><input type="checkbox"/> WB = 30D<br><input type="checkbox"/> VWB = 53D<br><input type="checkbox"/> MB-LIN = 48D x 22D<br><input type="checkbox"/> WB-LIN = 51D x 29D |  |  |  |  |
|  | <input type="checkbox"/> Richtbaar RS751B<br><br><input type="checkbox"/> Elbow RS752B | <input type="checkbox"/> LED26S (MB, WB, VWB, LIN) | <input type="checkbox"/> FMT   | <input type="checkbox"/> 3000 lm   | <input type="checkbox"/> MB = 21D<br><input type="checkbox"/> WB = 30D<br><input type="checkbox"/> VWB = 53D<br><input type="checkbox"/> MB-LIN = 48D x 22D<br><input type="checkbox"/> WB-LIN = 51D x 29D |  |  |  |  |
|  |  | <input type="checkbox"/> LED39S (MB, WB, VWB, LIN) | <input type="checkbox"/> 830<br><input type="checkbox"/> 930<br><input type="checkbox"/> 827<br><input type="checkbox"/> 840<br><input type="checkbox"/> CRW | <input type="checkbox"/> 3900 lm<br><input type="checkbox"/> 3900 lm<br><input type="checkbox"/> 3600 lm<br><input type="checkbox"/> 4200 lm<br><input type="checkbox"/> 3800 lm |  |  |  |  |  |
|  |  | <input type="checkbox"/> LED49S (MB, WB, VWB, LIN) | <input type="checkbox"/> 830<br><input type="checkbox"/> 930<br><input type="checkbox"/> 827<br><input type="checkbox"/> 840                                 | <input type="checkbox"/> 4900 lm<br><input type="checkbox"/> 4500 lm<br><input type="checkbox"/> 4500 lm<br><input type="checkbox"/> 5200 lm                                     |  |  |  |  |  |
|  |  |  |  |  |  |  |  |  |  |



# LuxSpace Accent Compact Elbow



- Uiterst compacte 'look and feel'
- Sterke optische prestaties



Winkeliers worstelen steeds meer met almaar stijgende energieprijzen. Tegelijkertijd moeten ze de lichtkwaliteit behouden waaraan ze gewend zijn, hebben ze flexibiliteit nodig voor integratie in de architectuur en de juiste lichteffecten om de blik van de klant te trekken. En last but not least: ze hebben behoefte aan toekomstbestendige oplossingen die hen in staat stellen onderscheidende concepten te realiseren in hun winkel. Doordat hij licht van hoge kwaliteit levert, een krachtige bundel heeft en een uitstekend lichtrendement biedt, is LuxSpace Accent de ideale energiezuinige oplossing voor hedendaagse veeleisende winkeltoepassingen. Met zijn uiterst compacte en onopvallende vormfactor biedt LuxSpace Accent Compact Elbow sterke optische prestaties en complete richtopties. Voor mode- en voedingsmiddelenwinkels is deze spot ook verkrijgbaar met speciale lichtvarianten en LED-recepten om de aangeboden kleding en verse etenswaren in het allerbeste licht te presenteren.

- Type: RS742B
- Lichtbron: Niet vervangbare LED-module
- Lampvermogen: NB (LED15S CRW): 26 W. NB (LED20S): 25.5 W. MB, WB, VWB (LED12S): 6,6 tot 14,6 W (afhankelijk van lichtkleur). MB, WB, VWB (LED17S): 13 tot 21 W (afhankelijk van lichtkleur). MB, WB, VWB (LED19S FMT-Rosé): 31 W. MB, WB, VWB (LED26S FMT-Rosé): 49.5 W. MB, WB, VWB (LED27S): 21 tot 51 W (afhankelijk van lichtkleur). MB, WB, VWB (LED39S): 31 tot 38,5 W (afhankelijk van lichtkleur)
- Bundelhoek: NB (10 °). MB (28 °, ±2 ° afhankelijk van lichtopbrengst). WB (36 °, ±2 ° afhankelijk van lichtopbrengst). VWB (60 °, ±2 ° afhankelijk van lichtopbrengst). LIN (ovale lens)
- Lichtstroom: NB (LED15S CRW): 1550lm. NB (LED20S): 2000 tot 2400 lm (afhankelijk van lichtkleur). MB, WB, VWB (LED12S): 1200 lm. MB, WB, VWB (LED17S): 1700 lm. MB, WB, VWB (LED19S FMT-Rosé): 1900 lm. MB, WB, VWB (LED26S FMT-Rosé): 2600 lm. MB, WB, VWB (LED27S): 2700 lm. MB, WB, VWB (LED39S): 3900 lm
- Gecorreleerde kleurtemperatuur: 2700, 3000, 4000 K
- Kleurweergave-index (CRI): 80. 90
- Gemiddelde levensduur L70B50: 70.000 uur
- Gemiddelde levensduur L80B50: 50.000 uur
- Gemiddelde levensduur L90B50: 25.000 uur
- Gemiddelde omgevingstemperatuur: +25 °C
- Bereik van bedrijfstemperatuur: +10 °C tot +35 °C
- Driver: Ingebouwd
- Netspanning: 230 of 240 V/50-60 Hz
- Dimmen: DALI
- Materiaal: Behuizing: gietaluminium. Lichtkap: acrylaat of glas. Optiek: kunststof
- Kleur: Zwart (BK, RAL9004). Wit (WH, RAL9003). Grijs, (SI, RAL9006). Andere RAL-kleuren op aanvraag verkrijgbaar
- Lichtkap; Gebogen glas (smalle bundel). Acrylaat (andere bundels)
- Aansluiting: Insteekverbinding (PI) of met trekontlasting (PIP). Wieland/Adels insteekconnector, 3-polige netspanning (en 2-polig regelsignaal) (W)
- Installatie; Bevestiging door middel van verende klemmen



RS742B

### Bestelgegevens

| EOC | Type aanduiding                          | Typenummer      | MOQ | VRG  | Richtprijs |
|-----|--|-----------------|-----|------|------------|
|     |  |                 |     | code |            |
| [5] | 16783700 RS742B LED12S/827 PSU-E MB BK   | RS742B12S827PMB | 1   | 89   | 206,10     |
| [5] | 16784400 RS742B LED15S/CRW PSE-E NB BK   | RS742B15SCPNBBK | 1   | 89   | 206,10     |
| [5] | 16785100 RS742B LED17S/830 PSU-E WB WH   | RS742B1783PWBW  | 1   | 89   | 206,10     |
| [5] | 16786800 RS742B LED19S/FMT PSU-E MB SI   | RS742B19FPMBSI  | 1   | 89   | 233,10     |
| [5] | 16787500 RS742B LED20S/827 PSE-E NB BK   | RS742B20S82PNBB | 1   | 89   | 206,10     |
| [5] | 16788200 RS742B LED26S/FMT PSU-E VWB WH  | RS742B26SFPVWBW | 1   | 89   | 260,10     |
| [5] | 16789900 RS742B LED27S/840 PSU-E VWB SI  | RS742B2784PVBSI | 1   | 89   | 233,10     |
| [5] | 16790500 RS742B LED27S/CH PSE-E MB WH    | RS742B27SCHPMBW | 1   | 89   | 260,10     |
| [5] | 16791200 RS742B LED39S/830 PSED-E VWB WH | RS742B3983PDVBW | 1   | 89   | 287,10     |
| [5] | 16792900 RS742B LED39S/PW9 PSU-E WB WH   | RS742B39P9PWBW  | 1   | 89   | 260,10     |

# GreenSpace 2 Mini DN460B/DN461B



- Perfecte renovatie-oplossing
- Tot wel 60% energiebesparing t.o.v. 2x18 W PL-C downlights
- Geen lampvervanging meer door de extreem lange levensduur



De GreenSpace Mini is de perfecte renovatie-oplossing door het eenvoudige installeren en de juiste gatmaat van 150 mm. Lichttechnisch biedt de GreenSpace Mini een uitstekend alternatief voor 2x18W PL-C downlights.

- Tot wel 60% energiebesparing
- Versie: DN460B (UGR22), DN461B (UGR19)
- Optiek: standaard hoogglans (C)
- Lichtbron: LED
- Systeemoutput: 1200 lm (UGR22), 1150 lm (UGR19)
- Systeemvermogen: 13,8 W
- Levensduur: 50.000 uur (bij 80% lumenbehoud, bij Ta 25 °C)
- Kleurtemperatuur: 3000 K of 4000 K
- Kleurweergave: Ra > 80
- Driver: LED driver standaard aangesloten meegeleverd; PSU niet dimbaar, PSD dimbaar middels DALI; powerfactor > 0,9
- Lichtregeling: PSD dimbaar middels OccuSwitch DALI
- Elektrische aansluiting: standaard middels push-in connector
- Materiaal: heatsink van aluminium, rim en optiek van hoogwaardig kunststof, rim in wit (WH, RAL 9010)
- Montage: inbouw, gatmaat 150 mm
- Opties:
  - IP44 versie
  - noodverlichting
  - opale cover
  - CU3 connector voor doorvoerbedrading
- Accessoires:
  - adapterringen voor gatmaten van 225 mm (op aanvraag)



DN460B

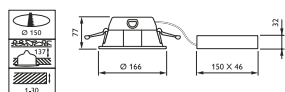

DN460B en DN461B. Afmetingen in mm. DN461B



## Bestelgegevens

### GreenSpace Mini DN460B - UGR22

| EOC | Type aanduiding                                 | Typenummer      | MOQ | VRG code | Gewicht (KG) | Richtprijs |
|-----|---|-----------------|-----|----------|--------------|------------|
| 1   | 24315200 DN460B LED11S/830 PSE-E C WH           | DN460B11S83WH   | 1   | 89       | 0,96         | 121,50     |
| 1   | 24316900 DN460B LED11S/840 PSE-E C WH           | DN460B11S84WH   | 1   | 89       | 0,96         | 121,50     |
| 5   | 24317600 DN460B LED11S/830 PSE-E C ELP3 WH      | DN460B11S83ELWH | 1   | 89       | 2,06         | 301,50     |
| 5   | 24318300 DN460B LED11S/840 PSE-E C ELP3 WH      | DN460B11S84ELWH | 1   | 89       | 2,06         | 301,50     |
| 5   | 24319000 DN460B LED11S/830 PSE-E C WH GC        | DN460B11S83IPWH | 1   | 89       | 1,02         | 144,00     |
| 5   | 24320600 DN460B LED11S/840 PSE-E C WH GC        | DN460B11S84IPWH | 1   | 89       | 1,02         | 144,00     |
| 1   | 24321300 DN460B LED11S/830 PSED-E C WH          | DN460B11S83DWH  | 1   | 89       | 0,96         | 148,50     |
| 3   | 24322000 DN460B LED11S/840 PSED-E C WH          | DN460B11S84DWH  | 1   | 89       | 0,96         | 148,50     |
| 5   | 24323700 DN460B LED11S/830 PSED-E C ELP3 WH     | DN460B11S83DELW | 1   | 89       | 2,06         | 328,50     |
| 5   | 24324400 DN460B LED11S/840 PSED-E C ELP3 WH     | DN460B11S84DELW | 1   | 89       | 2,06         | 328,50     |
| 5   | 24325100 DN460B LED11S/830 PSED-E C WH GC       | DN460B11S83DIPW | 1   | 89       | 1,02         | 171,00     |
| 5   | 24326800 DN460B LED11S/840 PSED-E C WH GC       | DN460B11S84DIPW | 1   | 89       | 1,02         | 171,00     |
| 5   | 24631300 DN460B LED11S/830 PSE-E C WH PGO       | DN460B11S83PGIP | 1   | 89       | 1,02         | 153,00     |
| 5   | 24632000 DN460B LED11S/840 PSE-E C WH PGO       | DN460B11S84PGIP | 1   | 89       | 1,02         | 153,00     |
| 5   | 24637500 DN460B LED11S/830 PSED-E C WH PGO      | DN460B11S83DPIP | 1   | 89       | 1,02         | 180,00     |
| 5   | 24638200 DN460B LED11S/840 PSED-E C WH PGO      | DN460B11S84DPIP | 1   | 89       | 1,02         | 180,00     |
| 4   | 24639900 DN460B LED11S/830 PSE-E C WH CU3       | DN460B11S83CWH  | 1   | 89       | 1,01         | 145,00     |
| 4   | 24640500 DN460B LED11S/840 PSE-E C WH CU3       | DN460B11S84CWH  | 1   | 89       | 1,01         | 130,50     |
| 5   | 24641200 DN460B LED11S/830 PSE-E C ELP3 WH CU3  | DN460B11S83ELCW | 1   | 89       | 2,11         | 310,50     |
| 5   | 24642900 DN460B LED11S/840 PSE-E C ELP3 WH CU3  | DN460B11S84ELCW | 1   | 89       | 2,11         | 310,50     |
| 5   | 24644300 DN460B LED11S/840 PSE-E C WH CU3 GC    | DN460B11S84CIPW | 1   | 89       | 1,08         | 153,00     |
| 4   | 24646700 DN460B LED11S/840 PSED-E C WH CU5      | DN460B11S84DCW  | 1   | 89       | 1,01         | 157,50     |
| 5   | 24647400 DN460B LED11S/830 PSED-E C ELP3 WH CU5 | DN460B11S83DECW | 1   | 89       | 2,11         | 337,50     |
| 5   | 24648100 DN460B LED11S/840 PSED-E C ELP3 WH CU5 | DN460B11S84DECW | 1   | 89       | 2,11         | 337,50     |
| 5   | 24650400 DN460B LED11S/840 PSED-E C WH CU5 GC   | DN460B11S84DCIW | 1   | 89       | 1,08         | 180,00     |
| 5   | 24656600 DN460B LED11S/840 PSE-E C WH CU3 PGO   | DN460B11S84PCIW | 1   | 89       | 1,08         | 162,00     |
| 5   | 24662700 DN460B LED11S/840 PSED-E C WH CU5 PGO  | DN460B11S84DPCI | 1   | 89       | 1,08         | 189,00     |

### GreenSpace Mini DN461B - UGR19

| EOC | Type aanduiding                                 | Typenummer      | MOQ | VRG code | Gewicht (KG) | Richtprijs |
|-----|---|-----------------|-----|----------|--------------|------------|
| 4   | 24327500 DN461B LED11S/830 PSE-E C WH           | DN461B11S83WH   | 1   | 89       | 0,96         | 144,00     |
| 4   | 24328200 DN461B LED11S/840 PSE-E C WH           | DN461B11S84WH   | 1   | 89       | 0,96         | 144,00     |
| 5   | 24329900 DN461B LED11S/830 PSE-E C ELP3 WH      | DN461B11S83ELWH | 1   | 89       | 2,06         | 324,00     |
| 5   | 24330500 DN461B LED11S/840 PSE-E C ELP3 WH      | DN461B11S84ELWH | 1   | 89       | 2,06         | 324,00     |
| 4   | 24331200 DN461B LED11S/830 PSED-E C WH          | DN461B11S83DWH  | 1   | 89       | 0,96         | 171,00     |
| 4   | 24332900 DN461B LED11S/840 PSED-E C WH          | DN461B11S84DWH  | 1   | 89       | 0,96         | 171,00     |
| 5   | 24333600 DN461B LED11S/830 PSED-E C ELP3 WH     | DN461B11S83DELW | 1   | 89       | 2,06         | 351,00     |
| 5   | 24334300 DN461B LED11S/840 PSED-E C ELP3 WH     | DN461B11S84DELW | 1   | 89       | 2,06         | 351,00     |
| 4   | 24664100 DN461B LED11S/840 PSE-E C WH CU3       | DN461B11S84CUWH | 1   | 89       | 1,02         | 153,00     |
| 5   | 24665800 DN461B LED11S/830 PSE-E C ELP3 WH CU3  | DN461B11S83ELCW | 1   | 89       | 2,12         | 333,00     |
| 5   | 24666500 DN461B LED11S/840 PSE-E C ELP3 WH CU3  | DN461B11S84ELCW | 1   | 89       | 2,12         | 333,00     |
| 4   | 24668900 DN461B LED11S/840 PSED-E C WH CU5      | DN461B11S84DCUW | 1   | 89       | 1,02         | 179,10     |
| 5   | 24669600 DN461B LED11S/830 PSED-E C ELP3 WH CU5 | DN461B11S83DECW | 1   | 89       | 2,12         | 359,10     |
| 5   | 24670200 DN461B LED11S/840 PSED-E C ELP3 WH CU5 | DN461B11S84DECW | 1   | 89       | 2,12         | 359,10     |

# GreenSpace 2 Compact DN470B/DN471B



- Perfecte renovatie-oplossing
- Tot wel 60% energiebesparing t.o.v. 2x26 W PL-C downlights
- Geen lampvervanging meer door de extreem lange levensduur



De GreenSpace Compact is de perfecte renovatieoplossing door het eenvoudige installeren en de juiste gatmaat van 200 mm. Lichttechnisch biedt de GreenSpace Compact een uitstekend alternatief voor 2x26 W PL-C downlights.

- Tot wel 60% energiebesparing
- Versie: DN470B (UGR22), DN471B (UGR19)
- Optiek: standaard hoogglans (C)
- Lichtbron: LED
- Systeemoutput: 2200 lm (UGR22), 2100 lm (UGR19)
- Systeemvermogen: 24 W
- Levensduur: 50.000 uur (bij 80% lumenbehoud, bij Ta 25 °C)
- Kleurtemperatuur: 3000 K of 4000 K
- Kleurweergave: Ra > 80
- Driver: LED driver standaard aangesloten meegeleverd; PSU niet dimbaar, PSD dimbaar middels DALI; powerfactor > 0,9
- Lichtregeling: PSD dimbaar middels OccuSwitch DALI LRM2070
- Elektrische aansluiting: standaard middels push-in connector
- Materiaal: heatsink van aluminium, rim en optiek van hoogwaardig kunststof, rim in wit (WH, RAL 9010)
- Montage: inbouw, gatmaat 200 mm
- Opties:
  - IP44 versie
  - noodverlichting
  - opale cover
  - CU3 connector voor doorvoerbedrading
- Accessoires:
  - adapterringen voor gatmaten van 225 mm (op aanvraag)



DN471B



DN470B

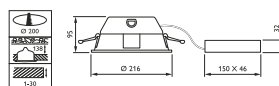

DN470B en DN471B. Afmetingen in mm.

## Bestelgegevens

### GreenSpace Compact DN470B - UGR22

| EOC | Type aanduiding                                 | Typenummer      | MOQ | VRG code | Gewicht (KG) | Richtprijs |
|-----|---|-----------------|-----|----------|--------------|------------|
| 1   | 24335000 DN470B LED20S/830 PSE-E C WH           | DN470B20S83WH   | 1   | 89       | 1,38         | 144,00     |
| 1   | 24336700 DN470B LED20S/840 PSE-E C WH           | DN470B20S84WH   | 1   | 89       | 1,38         | 144,00     |
| 5   | 24337400 DN470B LED20S/830 PSE-E C ELP3 WH      | DN470B20S83ELWH | 1   | 89       | 2,48         | 324,00     |
| 5   | 24338100 DN470B LED20S/840 PSE-E C ELP3 WH      | DN470B20S84ELWH | 1   | 89       | 2,48         | 324,00     |
| 5   | 24339800 DN470B LED20S/830 PSE-E C WH GC        | DN470B20S83IPWH | 1   | 89       | 1,50         | 166,50     |
| 5   | 24340400 DN470B LED20S/840 PSE-E C WH GC        | DN470B20S84IPWH | 1   | 89       | 1,50         | 166,50     |
| 3   | 24341100 DN470B LED20S/830 PSED-E C WH          | DN470B20S83DWH  | 1   | 89       | 1,38         | 171,00     |
| 1   | 24342800 DN470B LED20S/840 PSED-E C WH          | DN470B20S84DWH  | 1   | 89       | 1,38         | 171,00     |
| 5   | 24343500 DN470B LED20S/830 PSED-E C ELP3 WH     | DN470B20S83DELW | 1   | 89       | 2,48         | 351,00     |
| 5   | 24344200 DN470B LED20S/840 PSED-E C ELP3 WH     | DN470B20S84DELW | 1   | 89       | 2,48         | 351,00     |
| 5   | 24345900 DN470B LED20S/830 PSED-E C WH GC       | DN470B20S83DIPW | 1   | 89       | 1,50         | 193,50     |
| 5   | 24346600 DN470B LED20S/840 PSED-E C WH GC       | DN470B20S84DIPW | 1   | 89       | 1,50         | 193,50     |
| 5   | 24675700 DN470B LED20S/830 PSE-E C WH PGO       | DN470B20S83PIPW | 1   | 89       | 1,50         | 175,50     |
| 5   | 24676400 DN470B LED20S/840 PSE-E C WH PGO       | DN470B20S84PIPW | 1   | 89       | 1,50         | 175,50     |
| 5   | 24681800 DN470B LED20S/830 PSED-E C WH PGO      | DN470B20S83DPIW | 1   | 89       | 1,50         | 202,50     |
| 5   | 24682500 DN470B LED20S/840 PSED-E C WH PGO      | DN470B20S84DPIW | 1   | 89       | 1,50         | 202,50     |
| 4   | 24683200 DN470B LED20S/830 PSE-E C WH CU3       | DN470B20S83PCUW | 1   | 89       | 1,44         | 153,00     |
| 5   | 24685600 DN470B LED20S/830 PSE-E C ELP3 WH CU3  | DN470B20S83PECW | 1   | 89       | 2,54         | 333,00     |
| 5   | 24686300 DN470B LED20S/840 PSE-E C ELP3 WH CU3  | DN470B20S84PECW | 1   | 89       | 2,54         | 333,00     |
| 5   | 24687000 DN470B LED20S/830 PSE-E C WH CU3 GC    | DN470B20S83PCIW | 1   | 89       | 1,55         | 175,50     |
| 4   | 24689400 DN470B LED20S/830 PSED-E C WH CU5      | DN470B20S83DCUW | 1   | 89       | 1,44         | 180,00     |
| 5   | 24691700 DN470B LED20S/830 PSED-E C ELP3 WH CU5 | DN470B20S83DECW | 1   | 89       | 2,54         | 360,00     |
| 5   | 24692400 DN470B LED20S/840 PSED-E C ELP3 WH CU5 | DN470B20S84DECW | 1   | 89       | 2,54         | 360,00     |
| 5   | 24693100 DN470B LED20S/830 PSED-E C WH CU5 GC   | DN470B20S83DCIW | 1   | 89       | 1,55         | 202,50     |
| 5   | 24699300 DN470B LED20S/830 PSE-E C WH CU3 PGO   | DN470B20S83GCIW | 1   | 89       | 1,55         | 184,50     |
| 5   | 24705100 DN470B LED20S/830 PSED-E C WH CU5 PGO  | DN470B20D83GCIW | 1   | 89       | 1,55         | 211,50     |
| 5   | 17285500 DN470B LED30S/830 POE C SI             | DN470B001       | 1   | 89       |              | 243,00     |

### GreenSpace Compact DN471B - UGR19

| EOC | Type aanduiding                                 | Typenummer      | MOQ | VRG code | Gewicht (KG) | Richtprijs |
|-----|---|-----------------|-----|----------|--------------|------------|
| 4   | 24347300 DN471B LED20S/830 PSE-E C WH           | DN471B20S83WH   | 1   | 89       | 1,40         | 166,50     |
| 4   | 24348000 DN471B LED20S/840 PSE-E C WH           | DN471B20S84WH   | 1   | 89       | 1,40         | 166,50     |
| 5   | 24349700 DN471B LED20S/830 PSE-E C ELP3 WH      | DN471B20S83ELWH | 1   | 89       | 2,50         | 346,50     |
| 5   | 24350300 DN471B LED20S/840 PSE-E C ELP3 WH      | DN471B20S84ELWH | 1   | 89       | 2,50         | 346,50     |
| 4   | 24351000 DN471B LED20S/830 PSED-E C WH          | DN471B20S83DWH  | 1   | 89       | 1,40         | 193,50     |
| 4   | 24352700 DN471B LED20S/840 PSED-E C WH          | DN471B20S84DWH  | 1   | 89       | 1,40         | 193,50     |
| 5   | 24353400 DN471B LED20S/830 PSED-E C ELP3 WH     | DN471B20S83DEWH | 1   | 89       | 2,50         | 373,50     |
| 5   | 24354100 DN471B LED20S/840 PSED-E C ELP3 WH     | DN471B20S84DEWH | 1   | 89       | 2,50         | 373,50     |
| 4   | 24707500 DN471B LED20S/830 PSE-E C WH CU3       | DN471B20S83CUWH | 1   | 89       | 1,45         | 175,50     |
| 5   | 24709900 DN471B LED20S/830 PSE-E C ELP3 WH CU3  | DN471B20S83ECWH | 1   | 89       | 2,55         | 355,50     |
| 5   | 24710500 DN471B LED20S/840 PSE-E C ELP3 WH CU3  | DN471B20S84ECWH | 1   | 89       | 2,55         | 355,50     |
| 4   | 24711200 DN471B LED20S/830 PSED-E C WH CU5      | DN471B20S83DCWH | 1   | 89       | 1,45         | 202,50     |
| 5   | 24713600 DN471B LED20S/830 PSED-E C ELP3 WH CU5 | DN471B20S83DECW | 1   | 89       | 2,55         | 382,50     |
| 5   | 24714300 DN471B LED20S/840 PSED-E C ELP3 WH CU5 | DN471B20S84DECW | 1   | 89       | 2,55         | 382,50     |

# GreenSpace Accent Cardanic



- Hoge lumenopbrengst van uiterst compacte en lage armatuur
- Cardanische pendelmontage (twee afzonderlijke kantelringen)
- Breed toepassingsbereik



Dankzij de GreenSpace Accent-serie kunnen winkeliers en gebouwbeheerders nu overstappen van CDM naar LED. Zo kunnen ze profiteren van de voordelen van de lichtkwaliteit van PerfectAccent van Philips en een aanzienlijke energiebesparing, en dat alles voor een redelijke initiële investering. De reguliere inbouwopening van de GreenSpace Accent Cardanic en speciale lichtopbrengsten maken latere installatie snel en gemakkelijk. Voor mode- en voedingsmiddelenwinkels is GreenSpace Accent Cardanic ook verkrijgbaar met speciale lichtvarianten en LED-recepten om de aangeboden kleding en verse etenswaren in het allerbeste licht te presenteren. Neem een kijkje op onze cataloguspagina's voor mode en voedsel voor meer informatie over CrispWhite, PremiumWhite, Fresh Food Meat en Fresh Food Champagne.

- Type: RS343B
- Type plafond: Plafonds met zichtbare en symmetrisch verdeckte T-profielen en stucwerkplafonds (gipskartonplaat)
- Lichtbron: Niet vervangbare LED-module
- Lampvermogen: 1700 lm - 15 W, 2700 lm - 27 W, 3900 lm - 34,5 W bij 3000 K; 1900 lm - 26 W; 2600 lm - 39 W bij FMT
- Bundelhoek: NB (10°), MB (24°), WB (36°)
- Lichtstroom: 1750, 2800, 4000 lm bij 3000 K. 1900, 2600 lm bij FMT: 2700 lm bij CH
- Gecorreleerde kleurtemperatuur: 2500 K (voor Fresh Food Champagne, CH). 2700 K: 3000 K (voor 830, PremiumWhite PW9, CrispWhite CRW, Fresh Food Meat FMT). 4000 K
- Kleurweergave-index (CRI): 80 voor /827 /830 /840 /FMT /CH. 90 voor /PW9. > 95 voor /CRW
- Gemiddelde levensduur L70B50: 70.000 uur
- Gemiddelde levensduur L80B50: 50.000 uur
- Gemiddelde levensduur L90B50: 25.000 uur
- Gemiddelde omgevingstemperatuur: +25 °C
- Bereik van bedrijfstemperatuur: +10 °C tot +40 °C
- Driver: Afzonderlijk
- Netspanning: 230 of 240 V/50-60 Hz
- Dimmen: Niet dimbaar (PSU-E). DALI-dimbaar (PSD-E)
- Materiaal: Behuizing: gietaluminium
- Kleur: Wit (WH, RAL9003), Zwart (BK, RAL 9004), Zilver (SI, RAL9006)
- Optiek: Gemetalliseerd polycarbonaat
- Lichtkap: PMMA, helder
- Aansluiting: Insteekconnector met trekontlasting (PIP), 3-polige Wieland/Adels-plug (CW3), 3-polige Wieland/Adels-plug met vergrendeling (CW-L)
- Installatie: Bevestiging door middel van verende klemmen. Doorvoerbedrading mogelijk
- Accessoires: Geen

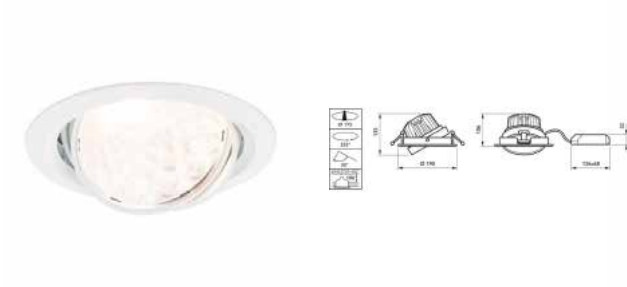

RS343B

Afmetingen in mm.

## Bestelgegevens

| EOC | Type aanduiding                                | Typenummer      | MOQ | VRG  | Richtprijs |
|-----|--|-----------------|-----|------|------------|
|     |  |                 |     | code |            |
| ☐   | 16471300 RS343B LED27S/PW9 PSU-E MB II WH      | RS343B27P9PMBWH | 1   | 89   | 188,10     |
| ☐   | 16473700 RS343B LED39S/830 PSU-E WB II WH      | RS343B3983PWBWH | 1   | 89   | 215,10     |
| ☐   | 16475100 RS343B LED26S/FMT PSU-E MB II WH      | RS343B26SFPMBWH | 1   | 89   | 215,10     |
| ☐   | 16546800 RS343B LED27S/830 PSU-E MB II WH      | RS343B2783PMBWH | 1   | 89   | 188,10     |
| ☐   | 16547500 RS343B LED27S/840 PSU-E MB II WH      | RS343B2784PMBWH | 1   | 89   | 188,10     |
| ☐   | 16793600 RS343B LED17S/830 PSU-E WB II WH      | RS343B1783PWBWH | 1   | 89   | 161,10     |
| ☐   | 16794300 RS343B LED17S/840 PSU-E WB II WH      | RS343B1784PWBWH | 1   | 89   | 161,10     |
| ☐   | 16795000 RS343B LED27S/830 PSU-E WB II WH      | RS343B2783PWBWH | 1   | 89   | 188,10     |
| ☐   | 16796700 RS343B LED27S/840 PSU-E WB II WH      | RS343B2784PWBWH | 1   | 89   | 188,10     |
| ☐   | 16797400 RS343B LED19S/FMT PSU-E WB II WH      | RS343B19SFPWBWH | 1   | 89   | 188,10     |
| ☐   | 16798100 RS343B LED17S/CRW PSU-E WB II WH      | RS343B17CPWBWH  | 1   | 89   | 161,10     |
| ☐   | 16799800 RS343B LED27S/CRW PSU-E MB II WH      | RS343B27CPMBWH  | 1   | 89   | 188,10     |
| ☐   | 16800100 RS343B LED27S/CRW PSU-E WB II WH      | RS343B27CPWBWH  | 1   | 89   | 188,10     |
| ☐   | 16801800 RS343B LED39S/840 PSU-E WB II WH      | RS343B3984PWBWH | 1   | 89   | 215,10     |
| ☐   | 16802500 RS343B LED17S/PW9 PSU-E WB II WH      | RS343B17P9PWBWH | 1   | 89   | 161,10     |
| ☐   | 16803200 RS343B LED27S/PW9 PSU-E WB II WH      | RS343B27P9PWBWH | 1   | 89   | 188,10     |
| ☐   | 16804900 RS343B LED39S/PW9 PSU-E WB II WH      | RS343B39P9PWBWH | 1   | 89   | 215,10     |
| ☐   | 16805600 RS343B LED27S/PW9 PSU-E MB II WH CW-L | RS343B27P9PMWHC | 1   | 89   | 192,60     |
| ☐   | 16806300 RS343B LED39S/PW9 PSU-E WB II WH CW-L | RS343B39P9PWWC  | 1   | 89   | 219,60     |
| ☐   | 16807000 RS343B LED27S/PW9 PSD-E MB II WH CW-L | RS343B27P9PDMWC | 1   | 89   | 219,60     |
| ☐   | 16808700 RS343B LED39S/PW9 PSD-E WB II WH CW-L | RS343B39P9PDWWC | 1   | 89   | 246,60     |
| ☐   | 16809400 RS343B LED27S/827 PSU-E MB II WH      | RS343B278PMBWH  | 1   | 89   | 188,10     |
| ☐   | 16810000 RS343B LED39S/827 PSU-E WB II WH      | RS343B398PWBWH  | 1   | 89   | 215,10     |
| ☐   | 16811700 RS343B LED27S/827 PSD-E MB II WH CW3  | RS343B278PDMBWC | 1   | 89   | 219,60     |
| ☐   | 16812400 RS343B LED27S/830 PSD-E MB II WH CW3  | RS343B2783PDMWC | 1   | 89   | 219,60     |
| ☐   | 16813100 RS343B LED39S/830 PSU-E MB II WH CW3  | RS343B3983PMBWC | 1   | 89   | 219,60     |
| ☐   | 16814800 RS343B LED27S/PW9 PSU-E NB II WH CW3  | RS343B27P9PNBWC | 1   | 89   | 192,60     |
| ☐   | 16815500 RS343B LED27S/PW9 PSU-E MB II WH CW3  | RS343B27P9PMBWC | 1   | 89   | 192,60     |
| ☐   | 16816200 RS343B LED27S/PW9 PSU-E WB II WH CW3  | RS343B27P9PWBWC | 1   | 89   | 192,60     |
| ☐   | 16817900 RS343B LED39S/830 PSU-E WB II WH CW3  | RS343B3983PWBWC | 1   | 89   | 219,60     |



# GreenSpace Accent Fixed



- Hoge lumenopbrengst van uiterst compacte en lage armatuur
- Geringe verblinding dankzij de licht verzonken reflector
- Breed toepassingsbereik



Dankzij de GreenSpace Accent-serie kunnen winkeliers en gebouwbeheerders nu overstappen van CDM naar LED. Zo kunnen ze profiteren van de voordelen van de lichtkwaliteit van PerfectAccent van Philips en een aanzienlijke energiebesparing, en dat alles voor een redelijke initiële investering. De reguliere inbouwopening van de GreenSpace Accent Fixed en speciale lichtopbrengsten, maken latere installatie snel en gemakkelijk. Om het ideale verlichtingsplan voor uw winkel te voltooien, biedt GreenSpace Accent Fixed flexibel algemeen licht aan dat wordt ondersteund door een selectie van bundels, speciale lichtvarianten en LED-recepten om de aangeboden kleding en verse etenswaren in het allerbeste licht te kunnen presenteren. Neem een kijkje op onze cataloguspagina's voor mode en voedsel voor meer informatie over CrispWhite, PremiumWhite, Fresh Food Meat en Fresh Food Champagne.

- Type: RS340B
- Type plafond: Plafonds met zichtbare en symmetrisch verdekte T-profielen en stucwerkplafonds (gipskartonplaat)
- Lichtbron: Niet vervangbare LED-module
- Vermogen:
  - 1700 lm - 15 W, 2700 lm - 27 W, 3900 lm - 34,5 W bij 3000 K
  - 1900 lm - 26 W; 2600 lm - 39 W bij Fresh Food Meat (FMT)
- Stralingshoek:
  - MB (24°)
  - WB (36°)
  - VWB (60°)
- Lichtstroom:
  - 2800, 4000 lm bij 3000 K
  - 1900, 2600 lm bij FMT
  - 2700 lm bij Fresh Food Champagne (CH)
- Gecorreleerde kleurtemperatuur:
  - 2500 K (voor CH)
  - 2700, 3000 K (voor 830, PremiumWhite PW9, CrispWhite CRW, FMT)
  - 4000 K
- Kleurweergave-index (CRI):
  - 80 voor 827, 830, 840, FMT, CH
  - 90 voor PW9
  - > 95 voor CRW
- Mediaan nuttige levensduur L70B50: 70.000 uur
- Mediaan nuttige levensduur L80B50: 50.000 uur
- Gemiddelde levensduur L90B50: 25.000 uur
- Gemiddelde omgevingstemperatuur: 25 °C
- Bereik van bedrijfstemperatuur: 10 °C tot 40 °C
- Driver: Afzonderlijk
- Netspanning: 230 of 240 V/50-60 Hz
- Dimmen: Niet dimbaar (PSU-E). DALI-dimbaar (PSD-E)
- Materiaal: Behuizing:: gietaluminium
- Kleur: Wit (WH, RAL9003), Zwart (BK, RAL 9004), Zilver (SI, RAL9006)
- Lichtkap: PMMA, helder. Push-in connector met trekontlasting (PIP), 3-polige Wieland/Adels-plug (CW3), 3-polige Wieland/Adels-plug met vergrendeling (CW-L)
- Installatie: Bevestiging door middel van verende klemmen. Doorvoerbedrading is mogelijk

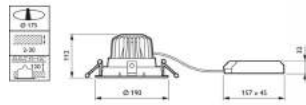

RS340B

Afmetingen in mm.

## Bestelgegevens

| EOC | Type aanduiding                                | Typenummer        | MOQ | VRG code | Richtprijs |
|-----|--|-------------------|-----|----------|------------|
| ☉   | 17194000 RS340B LED19S/FMT PSU-E WB II WH      | RS340B19FMTPBWB   | 1   | 89       | 170,10     |
| ☉   | 17195700 RS340B LED26S/FMT PSU-E MB II WH      | RS340B26SFPMBWB   | 1   | 89       | 197,10     |
| ☉   | 17196400 RS340B LED27S/830 PSU-E WB II WH      | RS340B2783PBWB    | 1   | 89       | 170,10     |
| ☉   | 17197100 RS340B LED27S/840 PSU-E WB II WH      | RS340B2784PBWB    | 1   | 89       | 170,10     |
| ☉   | 17198800 RS340B LED27S/CH PSU-E WB II WH       | RS340B27CHPBWB    | 1   | 89       | 197,10     |
| ☉   | 17199500 RS340B LED27S/CRW PSU-E WB II WH      | RS340B27CPWBWB    | 1   | 89       | 170,10     |
| ☉   | 17200800 RS340B LED27S/CRW PSD-E WB II WH      | RS340B27CPDWBWB   | 1   | 89       | 197,10     |
| ☉   | 17201500 RS340B LED27S/PW9 PSU-E WB II WH      | RS340B27P9PBWB    | 1   | 89       | 170,10     |
| ☉   | 17202200 RS340B LED27S/PW9 PSU-E MB II WH CW-L | RS340B27P9PMBWC   | 1   | 89       | 174,60     |
| ☉   | 17203900 RS340B LED27S/PW9 PSD-E MB II WH CW-L | RS340B27P9PDMWC   | 1   | 89       | 201,60     |
| ☉   | 17204600 RS340B LED27S/827 PSD-E MB II WH CW3  | RS340B2782PDMWC   | 1   | 89       | 201,60     |
| ☉   | 17205300 RS340B LED27S/830 PSD-E MB II WH CW3  | RS340B2783PDMWC   | 1   | 89       | 201,60     |
| ☉   | 17206000 RS340B LED27S/PW9 PSU-E MB II WH CW3  | RS340B27P9PMBW3   | 1   | 89       | 174,60     |
| ☉   | 17207700 RS340B LED27S/PW9 PSU-E WB II WH CW3  | RS340B27P9PBW3    | 1   | 89       | 174,60     |
| ☐   | 17208400 RS340B LED27S/830 PSU-E VWB II WH     | RS340B2783PVWBWB  | 1   | 89       | 170,10     |
| ☐   | 17209100 RS340B LED27S/830 PSD-E VWB II WH     | RS340B2783PDVWB   | 1   | 89       | 197,10     |
| ☉   | 17210700 RS340B LED39S/830 PSU-E WB II WH      | RS340B3983PBWB    | 1   | 89       | 197,10     |
| ☉   | 17211400 RS340B LED39S/827 PSU-E WB II WH      | RS340B39827PBWB   | 1   | 89       | 197,10     |
| ☉   | 17212100 RS340B LED39S/840 PSU-E WB II WH      | RS340B3984PBWB    | 1   | 89       | 197,10     |
| ☉   | 17213800 RS340B LED39S/840 PSD-E WB II WH      | RS340B3984PDWBWB  | 1   | 89       | 224,10     |
| ☉   | 17214500 RS340B LED39S/PW9 PSU-E WB II WH      | RS340B39P9PBWB    | 1   | 89       | 197,10     |
| ☉   | 17215200 RS340B LED39S/PW9 PSU-E WB II WH CW-L | RS340B39P9PMBWC   | 1   | 89       | 201,60     |
| ☉   | 17216900 RS340B LED39S/PW9 PSD-E WB II WH CW-L | RS340B39P9PDMWC   | 1   | 89       | 219,60     |
| ☉   | 17217600 RS340B LED39S/830 PSU-E WB II WH CW3  | RS340B3983PMBW3   | 1   | 89       | 201,60     |
| ☐   | 17218300 RS340B LED39S/830 PSU-E VWB II WH     | RS340B3983PVWBWB  | 1   | 89       | 197,10     |
| ☐   | 17219000 RS340B LED39S/830 PSD-E VWB II WH     | RS340B3983PDVWBWB | 1   | 89       | 224,10     |

# GreenSpace Accent Pendant



Dankzij de GreenSpace Accent familie kunnen retailers en gebouwbeheerders nu gemakkelijk de overstap maken van CDM naar LED. Hierdoor genieten zij zowel van de voordelen van de Philips PerfectAccent licht kwaliteit alsmede de significante energiebesparingen, en dit alles voor een gunstige prijs. GreenSpace Accent Pendant kan snel en gemakkelijk op een reguliere 3C spanningsrail worden geïnstalleerd, maar ook worden ingebouwd in het plafond. De kabel kan op lengte worden afgeknipt zodat men zelf de ideale positie van het luminair kan bepalen. Er zijn verschillende kleurtemperaturen beschikbaar voor zowel fashion/mode alsmede supermarkten/retail, zodat zowel kleding als verse producten optimaal kunnen worden belicht. Kijk in onze Fashion and Food catalogus om meer te weten te komen over CrispWhite, PremiumWhite, Fresh Food Meat en Fresh Food Champagne.

- Eenvoudig en robuust ontwerp
- Volledig retail concept in combinatie met projector, fixed downlight, cardanic en pendant
- Vergrootte flexibiliteit ten opzichte van CDM door naast nieuwe lumen pakketten en verbeterde energie efficiëntie ook de kleurtemperaturen voor de versafdeling in de supermarkt en slimme systeem integratie te bieden

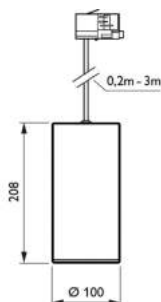

Afmetingen in mm.

## Bestelgegevens

| EOC        | Type aanduiding              | Typenummer | MOQ | VRG | Richtprijs<br>code |
|------------|------------------------------|------------|-----|-----|--------------------|
| ☒ 39145400 | PT320T LED17S/827 PSU MB WH  | PT320LED1  | 1   | 89  | 140,00             |
| ☒ 39146100 | PT320T LED17S/830 PSU MB BK  | PT320LED2  | 1   | 89  | 140,00             |
| ☒ 39147800 | PT320C LED17S/840 PSU MB WH  | PT320LED3  | 1   | 89  | 165,00             |
| ☒ 39148500 | PT320C LED17S/PW9 PSU WB BK  | PT320LED4  | 1   | 89  | 170,00             |
| ☒ 39149200 | PT320C LED17S/CRW PSU WB SI  | PT320LED5  | 1   | 89  | 175,00             |
| ☒ 39150800 | PT320T LED17S/CH PSU VWB BK  | PT320LED6  | 1   | 89  | 150,00             |
| ☒ 39151500 | PT320T LED19S/FMT PSD VWB BK | PT320LED7  | 1   | 89  | 200,00             |
| ☒ 39152200 | PT320T LED27S/827 PSD MB BK  | PT320LED8  | 1   | 89  | 180,00             |
| ☒ 39153900 | PT320T LED27S/830 PSD MB WH  | PT320LED9  | 1   | 89  | 180,00             |
| ☒ 39154600 | PT320T LED27S/840 PSD MB BK  | PT320LED10 | 1   | 89  | 180,00             |
| ☒ 39155300 | PT320T LED27S/PW9 PSD WB SI  | PT320LED11 | 1   | 89  | 175,00             |
| ☒ 39156000 | PT320T LED27S/CRW PSD WB BK  | PT320LED12 | 1   | 89  | 190,00             |

# CoreLine Downlight DN130B/DN131B



- Philips kwaliteit voor een scherpe prijs
- Energie-efficiënte LED technologie
- Bespaart lampvervangingen tot 2x18 W en 2x26 W PL downlights



De CoreLine Downlight is het instapmodel LED downlight. De scherpe prijs in combinatie met de goede specificaties en Philips kwaliteit maken dit product tot uitstekende keuze. De CoreLine Downlight reeks inbouwarmaturen is ontworpen ter vervanging van de tot 2x18 W en 2x26 W CFL gebaseerde downlight armaturen. Deze armaturen creëren een natuurlijk verlichtingseffect voor gebruik in algemene verlichtingstoepassingen. Ze leveren daarnaast onmiddellijke energiebesparingen en hebben een veel langere levensduur; dat maakt dat ze het geld waard zijn en een milieuvriendelijke oplossing bieden. Ze laten zich gemakkelijk installeren dankzij de insteekconnectors.

- Energie-efficiënte LED downlight
- Versie: DN130B (witte reflector), DN131B (hoogglans reflector)
- Optiek: wit
- Lichtbron: LED, 3000 K of 4000 K
- Systemoutput: 1100 lm (LED10S) of 2100 lm (LED20S)
- Systemvermogen:
  - LED10S: 11 W
  - LED20S: 22 W
- Levensduur: 50.000 uur (bij 70% lumenbehoud, L70B50, bij Ta 25 °C)
- Kleurtemperatuur: 3000 K of 4000 K
- Kleurweergave: Ra > 80
- Driver: LED driver standaard meegeleverd; powerfactor > 0,9
- Lichtregeling: DALI dimbaar
- Elektrische aansluiting: standaard middels push-in connector
- Materiaal: heatsink van aluminium, rim en optiek van hoogwaardig kunststof. Rim in wit (WH, RAL 9010)
- Montage: inbouw, gatmaat 150 mm (LED10S), 200 mm (LED20S)
- Opties:
  - IP44 versies in helder glas



DN130B LED10S/830 PSED-E II WH

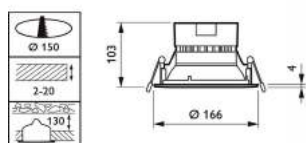

DN130B LED10S Afmetingen in mm.



DN130B LED20S

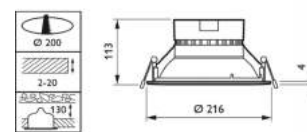

DN130B LED20S Afmetingen in mm.

## Bestelgegevens

| EOC | Type aanduiding                               | Typenummer      | MOQ | VRG code | Gewicht (KG) | Richtprijs |
|-----|---|-----------------|-----|----------|--------------|------------|
| 1   | 85222400 DN130B LED10S/830 PSU PI6 WH         | DN13B1S83PP6WH  | 1   | 75       | 0,70         | 69,00      |
| 1   | 85223100 DN130B LED10S/830 PSED-E II WH       | DN13B1S83PSDWH  | 1   | 75       | 0,80         | 109,00     |
| 1   | 85224800 DN130B LED20S/830 PSU PI6 WH         | DN13B2S83PP6WH  | 1   | 75       | 1,10         | 89,00      |
| 3   | 85225500 DN130B LED20S/830 PSED-E II WH       | DN13B2S83PSDWH  | 1   | 75       | 1,20         | 129,00     |
| 1   | 85226200 DN131B LED10S/830 PSU PI6 ALU        | DN131B1S83PP6AL | 1   | 75       | 0,70         | 69,00      |
| 1   | 85227900 DN131B LED10S/830 PSED-E II ALU      | DN131B1S83PSDAL | 1   | 75       | 0,70         | 109,00     |
| 1   | 85228600 DN131B LED20S/830 PSU PI6 ALU        | DN131B2S83PP6AL | 1   | 75       | 1,10         | 89,00      |
| 1   | 85229300 DN131B LED20S/830 PSED-E II ALU      | DN131B2S83PSDAL | 1   | 75       | 1,20         | 129,00     |
| 1   | 85269900 DN130B LED10S/840 PSU PI6 WH         | DN13B1S84PP6WH  | 1   | 75       | 0,70         | 69,00      |
| 1   | 85270500 DN130B LED10S/840 PSED-E II WH       | DN13B1S84PSDWH  | 1   | 75       | 0,80         | 109,00     |
| 1   | 85271200 DN130B LED20S/840 PSU PI6 WH         | DN13B2S84PP6WH  | 1   | 75       | 1,10         | 89,00      |
| 1   | 85272900 DN130B LED20S/840 PSED-E II WH       | DN13B2S84PSDWH  | 1   | 75       | 1,20         | 129,00     |
| 1   | 85273600 DN131B LED10S/840 PSU PI6 ALU        | DN131B1S84PP6AL | 1   | 75       | 0,70         | 69,00      |
| 1   | 85274300 DN131B LED10S/840 PSED-E II ALU      | DN131B1S84PSDAL | 1   | 75       | 0,80         | 109,00     |
| 1   | 85275000 DN131B LED20S/840 PSU PI6 ALU        | DN131B2S84PP6AL | 1   | 75       | 1,10         | 89,00      |
| 1   | 85276700 DN131B LED20S/840 PSED-E II ALU      | DN131B2S84PSDAL | 1   | 75       | 1,20         | 129,00     |
| 5   | 87881100 DN130B LED10S/830 PSU IP44 PI6 WH    | DN13B1S83IP6WH  | 1   | 75       | 0,70         | 89,00      |
| 5   | 87882800 DN130B LED10S/840 PSU IP44 PI6 WH    | DN13B1S84IP6WH  | 1   | 75       | 0,70         | 89,00      |
| 5   | 87883500 DN130B LED10S/830 PSED-E IP44 II WH  | DN13B1S83IPDWH  | 1   | 75       | 0,80         | 129,00     |
| 5   | 87884200 DN130B LED10S/840 PSED-E IP44 II WH  | DN13B1S84IPDWH  | 1   | 75       | 0,80         | 129,00     |
| 5   | 87885900 DN130B LED20S/830 PSU IP44 PI6 WH    | DN13B2S83IP6WH  | 1   | 75       | 1,10         | 109,00     |
| 5   | 87886600 DN130B LED20S/840 PSU IP44 PI6 WH    | DN13B2S84IP6WH  | 1   | 75       | 1,10         | 109,00     |
| 5   | 87887300 DN130B LED20S/830 PSED-E IP44 II WH  | DN13B2S83IPDWH  | 1   | 75       | 1,20         | 149,00     |
| 5   | 87888000 DN130B LED20S/840 PSED-E IP44 II WH  | DN13B2S84IPDWH  | 1   | 75       | 1,20         | 149,00     |
| 5   | 87889700 DN131B LED10S/830 PSU IP44 PI6 ALU   | DN131B1S83IP6AL | 1   | 75       | 0,70         | 89,00      |
| 5   | 87890300 DN131B LED10S/840 PSU IP44 PI6 ALU   | DN131B1S84IP6AL | 1   | 75       | 0,70         | 89,00      |
| 5   | 87891000 DN131B LED10S/830 PSED-E IP44 II ALU | DN131B1S83IPDAL | 1   | 75       | 0,80         | 129,00     |
| 5   | 87892700 DN131B LED10S/840 PSED-E IP44 II ALU | DN131B1S84IPDAL | 1   | 75       | 0,80         | 129,00     |
| 5   | 87893400 DN131B LED20S/830 PSU IP44 PI6 ALU   | DN131B2S83IP6AL | 1   | 75       | 1,10         | 109,00     |
| 5   | 87894100 DN131B LED20S/840 PSU IP44 PI6 ALU   | DN131B2S84IP6AL | 1   | 75       | 1,10         | 109,00     |
| 5   | 87895800 DN131B LED20S/830 PSED-E IP44 II ALU | DN131B2S83IPDAL | 1   | 75       | 1,20         | 149,00     |
| 5   | 87896500 DN131B LED20S/840 PSED-E IP44 II ALU | DN131B2S84IPDAL | 1   | 75       | 1,20         | 149,00     |
| 6   | 16221400 DN130B LED10S/830 PSED-E EL3 II WH   | DN130B1830PDELW | 1   | 75       |              | 309,00     |
| 6   | 16222100 DN130B LED10S/840 PSED-E EL3 II WH   | DN130B1840PDELW | 1   | 75       |              | 309,00     |
| 6   | 16017300 DN130B LED20S/830 PSED-E EL3 II WH   | DN130B2830PDELW | 1   | 75       |              | 329,00     |
| 6   | 16223800 DN130B LED20S/840 PSED-E EL3 II WH   | DN130B2840PDELW | 1   | 75       |              | 299,00     |
| 6   | 16224500 DN131B LED10S/830 PSED-E EL3 II ALU  | DN131B1830PDELA | 1   | 75       |              | 309,00     |
| 6   | 16225200 DN131B LED10S/840 PSED-E EL3 II ALU  | DN131B1840PDELA | 1   | 75       |              | 309,00     |
| 6   | 16226900 DN131B LED20S/830 PSED-E EL3 II ALU  | DN131B2830PDELA | 1   | 75       |              | 329,00     |
| 6   | 16187300 DN131B LED20S/840 PSED-E EL3 II ALU  | DN131B2840PDELA | 1   | 75       |              | 329,00     |

# Downlight DN060B



- De kwaliteit en betrouwbaarheid van Philips
- Energiebesparing
- Gemakkelijk installeren



Installeer vandaag nog de LEDinaire Downlight. De eenvoudige LED-oplossing als alternatief voor uw conventionele verlichting.

- Type: DN060B
- Type plafond: Stucwerkplafond (gipskartonplaat)
- Lichtbron: Niet vervangbare LED-module
- Vermogen ( $\pm 10\%$ ): 9, 18 W
- Stralingshoek: 135°
- Lichtstroom: 800 lm (4000 K), 1800 lm (4000 K)
- Gecorreleerde kleurtemperatuur: 3000 of 4000 K
- Kleurweergave-index (CRI): >80
- Mediaan nuttige levensduur L70B50: 30.000 uur
- Mediaan nuttige levensduur L80B50: 20.000 uur
- Mediaan nuttige levensduur L90B50: 10.000 uur
- Gemiddelde omgevingstemperatuur: 25 °C
- Bereik van bedrijfstemperatuur: 0 °C tot 35 °C
- Driver: Ingebouwd
- Netspanning: 220-240 V/50-60 Hz
- Materiaal: Behuizing: polycarbonaat. Reflector: staal. Diffuser: PMMA
- Kleur: Wit (WH)
- Lichtkap: Opaal
- Aansluiting: Push-in connector (PI) of met trekontlasting (PIP)
- Onderhoud: Optiekmodule permanent afgedicht, geen interne reiniging vereist
- Installatie: Bevestiging door middel van verende klemmen. Doorvoerbedrading mogelijk
- Accessoires: Nee

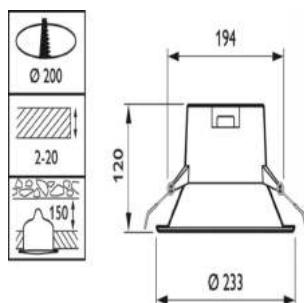

DN060B

Afmetingen in mm.

## Bestelgegevens

| EOC      | Type aanduiding          | Typenummer    | MOQ | VRG | Richtprijs<br>code |
|----------|--------------------------|---------------|-----|-----|--------------------|
| 30661299 | DN060B LED18S/830 PSU WH | DN060B1883PWH | 1   | 90  | 45,00              |
| 30662999 | DN060B LED8S/830 PSU WH  | DN060B883PWH  | 1   | 90  | 35,00              |
| 30663699 | DN060B LED18S/840 PSU WH | DN060B1884PWH | 1   | 90  | 45,00              |
| 30664399 | DN060B LED8S/840 PSU WH  | DN060B884PWH  | 1   | 90  | 35,00              |

# CoreLine Inbouw Spot RS140B/RS141B



- Philips kwaliteit voor een zeer scherpe prijs
- Echte 50 W laagvolt halogeen vervanger
- Gaat 20x langer mee dan een halogeen lamp



De CoreLine Inbouw Spot is een inbouw LED spot welke zeer geschikt is voor het creëren van subtiele accenten in diverse applicaties. Door unieke reflector-in-lens technologie een mooi uniforme en prettige lichtbundel.

- Vervangt 50 W halogeen
- Versie: inbouw vast (RS140B) is IP54, inbouw richtbaar (RS141B) is IP44
- Lichtbron: LED
- Lichtstroom: 650 lm / 1200 lm
- Optieken: 32D of 60D
- Systemvermogen: 10 W
- Levensduur: 50.000 uur (70% lumenbehoud bij Ta 25 °C)
- Kleurtemperatuur: 2700 K, 3000 K of 4000 K of DimTone technologie
- Kleurweergave: Ra > 80
- Driver: geïntegreerde driver
- Lichtregeling: dimbaar op alle bekende fase aan- en afsnijdende dimmers (selectie van geteste dimmers vindt u in onze online productcatalogus)
- Elektrische aansluiting: push-in connector met doorbedrading mogelijk
- Materiaal: armatuur van aluminium, kleur wit (WH) of geborsteld aluminium (ALU)
- Montage: inbouw, maar 59 mm hoogte. Ideaal voor geïsoleerde plafonds.



RS140B Wit

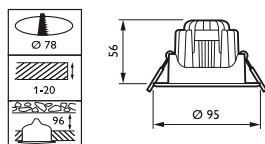

Afmetingen in mm.



RS141B Wit

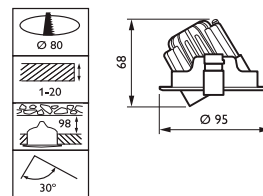

Afmetingen in mm.



RS140B Alu



RS141B Alu





RS141B unieke reflector-in- lens technologie

## Bestelgegevens

| EOC | Type aanduiding | Typenummer                      | MOQ           | VRG code | Gewicht (KG) | Richtprijs |
|-----|-----------------|---------------------------------|---------------|----------|--------------|------------|
| 1   | 38277399        | RS140B LED6-32-/827 PSR PI6 WH  | RS140LED6321  | 1        | 75           | 45,00      |
| 1   | 38278099        | RS140B LED6-32-/830 PSR PI6 WH  | RS140LED6322  | 1        | 75           | 45,00      |
| 1   | 38279799        | RS140B LED6-32-/840 PSR PI6 WH  | RS140LED6323  | 1        | 75           | 45,00      |
| 1   | 38280399        | RS141B LED6-32-/827 PSR PI6 WH  | RS141LED6324  | 1        | 75           | 49,00      |
| 1   | 38281099        | RS141B LED6-32-/830 PSR PI6 WH  | RS141LED6325  | 1        | 75           | 49,00      |
| 1   | 38282799        | RS141B LED6-32-/840 PSR PI6 WH  | RS141LED6326  | 1        | 75           | 49,00      |
| Ⓞ   | 38283499        | RS141B LED9-32-/830 PSR PI6 WH  | RS141LED9327  | 1        | 75           | 53,00      |
| Ⓞ   | 38284199        | RS141B LED9-32-/840 PSR PI6 WH  | RS141LED9328  | 1        | 75           | 53,00      |
| Ⓞ   | 38285899        | RS140B LED9-32-/830 PSR PI6 WH  | RS140LED9329  | 1        | 75           | 49,00      |
| Ⓞ   | 38286599        | RS140B LED9-32-/840 PSR PI6 WH  | RS140LED93210 | 1        | 75           | 49,00      |
| 1   | 38287299        | RS140B LED6-32-/827 PSR PI6 ALU | RS140LED63211 | 1        | 75           | 45,00      |
| 1   | 38288999        | RS140B LED6-32-/830 PSR PI6 ALU | RS140LED63212 | 1        | 75           | 45,00      |
| 1   | 38289699        | RS140B LED6-32-/840 PSR PI6 ALU | RS140LED63213 | 1        | 75           | 45,00      |
| 1   | 38290299        | RS141B LED6-32-/827 PSR PI6 ALU | RS141LED63214 | 1        | 75           | 49,00      |
| 1   | 38291999        | RS141B LED6-32-/830 PSR PI6 ALU | RS141LED63215 | 1        | 75           | 49,00      |
| 1   | 38292699        | RS141B LED6-32-/840 PSR PI6 ALU | RS141LED63216 | 1        | 75           | 49,00      |
| Ⓞ   | 38293399        | RS140B LED9-32-/830 PSR PI6 ALU | RS140LED93216 | 1        | 75           | 49,00      |
| Ⓞ   | 38294099        | RS140B LED9-32-/840 PSR PI6 ALU | RS140LED93217 | 1        | 75           | 49,00      |

### CoreLine Inbouw Spot (vast)

| EOC | Type aanduiding | Typenummer                      | MOQ             | VRG code | Gewicht (KG) | Richtprijs |       |
|-----|-----------------|---------------------------------|-----------------|----------|--------------|------------|-------|
| 1   | 06897799        | RS140B LED6-32-/827 PSR PI6 WH  | RS140B632827PWH | 1        | 75           | 0,59       | 45,00 |
| 1   | 06898499        | RS140B LED6-32-/830 PSR PI6 WH  | RS140B632830PWH | 1        | 75           | 0,59       | 45,00 |
| 1   | 06899199        | RS140B LED6-32-/840 PSR PI6 WH  | RS140B632840PWH | 1        | 75           | 0,59       | 45,00 |
| 1   | 06900499        | RS140B LED6-32-/827 PSR PI6 ALU | RS140B632827PAL | 1        | 75           | 0,59       | 45,00 |
| 1   | 06901199        | RS140B LED6-32-/830 PSR PI6 ALU | RS140B632830PAL | 1        | 75           | 0,59       | 45,00 |
| 1   | 06902899        | RS140B LED6-32-/840 PSR PI6 ALU | RS140B632840PAL | 1        | 75           | 0,59       | 45,00 |
| 1   | 07125099        | RS140B LED6-60-/830 PSR PI6 WH  | RS140B6683PWH   | 1        | 75           |            | 49,00 |
| Ⓞ   | 07126799        | RS140B LED6-60-/840 PSR PI6 WH  | RS140B6684PWH   | 1        | 75           |            | 49,00 |

### CoreLine Inbouw Spot (richtbaar)

| EOC | Type aanduiding | Typenummer                         | MOQ             | VRG code | Gewicht (KG) | Richtprijs |       |
|-----|-----------------|------------------------------------|-----------------|----------|--------------|------------|-------|
| 1   | 06903599        | RS141B LED6-32-/827 PSR PI6 WH     | RS141B632827PWH | 1        | 75           | 0,62       | 49,00 |
| 1   | 06904299        | RS141B LED6-32-/830 PSR PI6 WH     | RS141B632830PWH | 1        | 75           | 0,62       | 49,00 |
| 1   | 06905999        | RS141B LED6-32-/840 PSR PI6 WH     | RS141B632840PWH | 1        | 75           | 0,62       | 49,00 |
| 1   | 06906699        | RS141B LED6-32-/827 PSR PI6 ALU    | RS141B632827PAL | 1        | 75           | 0,62       | 49,00 |
| 1   | 06907399        | RS141B LED6-32-/830 PSR PI6 ALU    | RS141B632830PAL | 1        | 75           | 0,62       | 49,00 |
| 1   | 06908099        | RS141B LED6-32-/840 PSR PI6 ALU    | RS141B632840PAL | 1        | 75           | 0,62       | 49,00 |
| 1   | 07127499        | RS141B LED12-32-/830 PSR PI6 WH    | RS141B123283PWH | 1        | 75           |            | 65,00 |
| 1   | 07128199        | RS141B LED12-32-/840 PSR PI6 WH    | RS141B123284PWH | 1        | 75           |            | 65,00 |
| 1   | 07139799        | RS141B LED7-32-/830 PSR PI6 ALU DT | RS141B1232DTPAL | 1        | 75           |            | 60,00 |
| 1   | 07129899        | RS141B LED7-32-/830 PSR PI6 WH DT  | RS141B1232DTPWH | 1        | 75           |            | 60,00 |

# ClearAccent



- De gemakkelijkste en goedkoopste manier om over te schakelen van halogeen- naar LED-spots
- Max. 90% energiebesparing en 10x langere levensduur in vergelijking met standaard halogeenarmaturen
- Snel en gemakkelijk installeren door geïntegreerde driver



Installeer vandaag nog de LEDinaire ClearAccent Spot. De eenvoudige LED-oplossing als alternatief voor uw conventionele verlichting.

- Type: RS060B (vaste inbouwuitvoering). RS061B (verstelbare inbouwuitvoering)
- Type plafond: Stucwerkplafond (gipskartonplaat)
- Lichtbron: Niet vervangbare LED-module
- Lampvermogen: 6 W
- Bundelhoek: 36°
- Lichtstroom: 500lm
- Gecorreleerde kleurtemperatuur: 3000 of 4000 K
- Kleurweergave-index (CRI): > 80
- Gemiddelde levensduur L70B50: 25.000 uur
- Gemiddelde levensduur L80B50: 15.000 uur
- Gemiddelde levensduur L90B50: 10.000 uur
- Gemiddelde omgevingstemperatuur: 25 °C
- Bereik van bedrijfstemperatuur: 0 tot 40 °C
- Driver: Ingebouwd
- Voeding/gegevenstoevoer: Voeding/gegevenstoevoer
- Netspanning: 230 of 240 V/50-60 Hz
- Dimmen: Compatibel met de meeste opgaandeflank faseaansnijdingsdimmers
- Ingang voor regelsysteem: Niet van toepassing
- Opties: Vaste of verstelbare uitvoering
- Materiaal: Montagerand: gietaluminium. Achterbehuizing: polycarbonaat
- Kleur: Wit (WH)
- Lichtkap: Polycarbonaat, helder
- Aansluiting: Integrale stekker/contrastekker. 3-pins connector met trekontlasting
- Onderhoud: Geen
- Installatie: Bevestiging door middel van verende klemmen. Geen doorvoerbedrading mogelijk. Instelbare uitvoering is 25° kantelbaar
- Accessoires: Geen

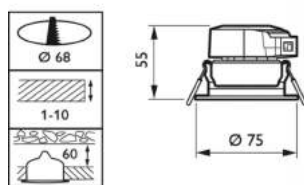

RS060B (vaste inbouwuitvoering)

Afmetingen in mm.

RS061B (verstelbare inbouwuitvoering)

## Bestelgegevens

| EOC | Type aanduiding                        | Typenummer     | MOQ VRG | Richtprijs code |
|-----|--|----------------|---------|-----------------|
| 1   | 07267799 RS060B LED5-36-/830 PSR II WH | RS060B53683PWH | 1       | 90 35,00        |
| 1   | 07268499 RS060B LED5-36-/840 PSR II WH | RS060B53684PWH | 1       | 90 35,00        |
| 1   | 07269199 RS061B LED5-36-/830 PSR II WH | RS061B53683PWH | 1       | 90 38,00        |
| 1   | 07270799 RS061B LED5-36-/840 PSR II WH | RS061B53684PWH | 1       | 90 38,00        |

# Zadora MASTER LED richtbaar RS049B



- De Zadora LED is een kleine inbouw LED spot die geschikt is voor het leggen van accenten in bijvoorbeeld winkels, hotels of kantoren.
- Een goede lichtkwaliteit voor een scherpe prijs
- Versies: inbouw rond richtbaar in wit (WH) of aluminium (ALU)
- Optieken: 40°
- Lichtbron: MASTER LEDspot MV Value GU10 4.3-50 W
- Systeemvermogen: 4.3 W
- Levensduur: 35.000 uur (70% lumenbehoud bij Ta 25 °C)
- Kleurtemperatuur: 2700 K of 3000 K
- Kleurweergave: Ra > 80
- Lichtregeling: Dimbaar (zie MASTER LEDlampen dimmerlijst)
- Elektrische aansluiting: schroefconnector
- Montage: inbouw
- Opties:
  - Configureer uw eigen Zadora MASTER LED door een losse Zadora Ring (BBG463) te bestellen in combinatie met elke Philips LEDLamp

- Geen lampvervanging meer nodig door de lange levensduur
- 80% energiebesparing t.o.v. 50 W halogeen
- Eenvouding te bestellen als KIT verpakking

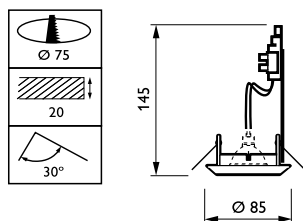

RS049B ALU

Afmetingen in mm.

## Bestelgegevens

| EOC | Type aanduiding                                | Typenummer     | MOQ | VRG code | Gewicht (KG) | Richtprijs |
|-----|--|----------------|-----|----------|--------------|------------|
| 1   | 07012399 RS049B LED-MS-40-5W-2700-GU10 WH 50W  | RS049B5327WH50 | 1   | 75       | 0,35         | 22,00      |
| 1   | 07013099 RS049B LED-MS-40-5W-4000-GU10 WH 50W  | RS049B5340WH50 | 1   | 75       | 0,35         | 22,00      |
| 1   | 07014799 RS049B LED-MS-40-5W-2700-GU10 ALU 50W | RS049B5327AL50 | 1   | 75       | 0,35         | 22,00      |
| 1   | 07015499 RS049B LED-MS-40-5W-3000-GU10 WH 50W  | RS049B5330WH50 | 1   | 75       | 0,35         | 22,00      |
| 1   | 07016199 RS049B LED-MS-40-5W-3000-GU10 ALU 50W | RS049B5340AL50 | 1   | 75       | 0,35         | 22,00      |

## Losse Zadora ring

| EOC | Type aanduiding                 | Typenummer     | MOQ | VRG code | Gewicht (KG) | Richtprijs |
|-----|---------------------------------|----------------|-----|----------|--------------|------------|
| 1   | 89980799 BBG463 MAX35W-GU10 WH  | BBG463GU10RWH  | 1   | 75       | 0,24         | 8,00       |
| 1   | 89981499 BBG463 MAX35W-GU10 ALU | BBG463GU10RALU | 1   | 75       | 0,24         | 8,00       |

# Europa 2 FBS120



- Zeer snelle installatie
- Voorgemonteerde lampen en snoer+stekker of Wieland
- Goede optiekrendementen



**ECONOMY**

De Europa 2 is een familie vaste inbouw downlights voor compact fluorescentie lampen en zijn voorzien van hoogfrequente voorschakelapparatuur. Deze downlights zijn toepasbaar in gangen, toiletten, wachtruimtes, entreehallen en winkelruimtes.

- LED alternatief: bespaar tot wel 60% energie met de LuxSpace
- Versies: FBS120 (gatmaat 223 mm)
- Lichtbron: MASTER PL-C 4 Pin 13/18/26 W of MASTER PL-R Eco 4 pin 17 W, een of twee lamp varianten, lampen worden in kleur 830 of 840 meegeleverd
- VSA: extern HF VSA wordt aangesloten meegeleverd; de HF-H VSA zit alleen nog vast aan de armatuur middels een kabel en rust op het plafond, dit vereenvoudigt de installatie
- Elektrische aansluiting: Wieland (CW2 of CW3) of snoer en stekker (CCE)
- Materiaal: behuizing van hoogwaardig kunststof
- Kleur: wit (WH)
- Opties:
  - P20 prisma fresnel-afscherming (P)
  - viervaks-louvre (L)
- Accessoires: diverse voorzetglazen



FBS120 P

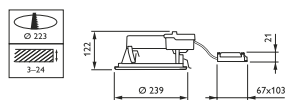

FBS120 Afmetingen in mm.



FBS120 PG



FBS120 L



FBS120 met extern HF-HVSA

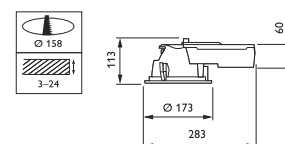

FBS122 Afmetingen in mm.



GBS120/FBS122 + ZBS120/ZBS122 FRG-C  
Europa 2 met decoratieve ring



GBS120/GBS122 O  
Opaalglas (O)



GBS120/GBS122 P  
Prisma afscherming (P)

## Bestelgegevens

### Europa2 FBS120

| EOC | Type aanduiding                              | Typenummer      | MOQ | VRG code | Gewicht (KG) | Richtprijs |
|-----|--|-----------------|-----|----------|--------------|------------|
| 5   | 08588100 FBS120 2XPL-C/4P18W/830 HF-H O CCE  | FBS120218830OCE | 1   | 74       | 1,52         | 150,00     |
| 5   | 08587400 FBS120 2XPL-C/4P18W/830 HF-H O CW3  | FBS120218830OC3 | 1   | 74       | 1,47         | 158,00     |
| 5   | 08580500 FBS120 2XPL-C/4P18W/830 HF-H P CW2  | FBS120218830PC2 | 1   | 74       | 1,43         | 157,00     |
| 5   | 08585000 FBS120 2XPL-C/4P18W/830 HF-H PG CCE | FBS120218830GCE | 1   | 74       | 1,97         | 150,00     |
| 5   | 08593500 FBS120 2XPL-C/4P18W/840 HF-H P CW3  | FBS120218840PC3 | 1   | 74       | 1,44         | 158,00     |
| 4   | 08608600 FBS120 2XPL-C/4P26W/830 HF-H PG CW3 | FBS120226830GC3 | 1   | 74       | 1,72         | 158,00     |
| 5   | 08613000 FBS120 2XPL-C/4P26W/840 HF-H P CW2  | FBS120226840PC2 | 1   | 74       | 1,46         | 168,00     |
| 5   | 08645100 FBS120 2XPL-C/4P18W/ HF P EL3       | FBS120218PEL3   | 1   | 74       | 3,49         | 368,00     |
| 5   | 08582900 FBS120 2XPL-C/4P18W/830 HF-H P CCE  | FBS120218830PCE | 1   | 74       | 1,45         | 150,00     |
| 5   | 08581200 FBS120 2XPL-C/4P18W/830 HF-H P CW3  | FBS120218830PC3 | 1   | 74       | 1,44         | 158,00     |
| 5   | 08584300 FBS120 2XPL-C/4P18W/830 HF-H PG CW3 | FBS120218830GC3 | 1   | 74       | 1,70         | 158,00     |
| 5   | 08596600 FBS120 2XPL-C/4P18W/840 HF-H PG CW3 | FBS120218840GC3 | 1   | 74       | 1,70         | 158,00     |
| 5   | 08649900 FBS120 2XPL-C/4P26W/ HF P EL3       | FBS120226PEL3   | 1   | 74       | 3,22         | 368,00     |
| 5   | 08606200 FBS120 2XPL-C/4P26W/830 HF-H P CCE  | FBS120226830PCE | 1   | 74       | 1,47         | 150,00     |
| 4   | 08605500 FBS120 2XPL-C/4P26W/830 HF-H P CW3  | FBS120226830PC3 | 1   | 74       | 1,46         | 158,00     |
| 5   | 08609300 FBS120 2XPL-C/4P26W/830 HF-H PG CCE | FBS120226830GCE | 1   | 74       | 1,99         | 150,00     |
| 5   | 08614700 FBS120 2XPL-C/4P26W/840 HF-H P CW3  | FBS120226840PC3 | 1   | 74       | 1,46         | 158,00     |
| 5   | 08617800 FBS120 2XPL-C/4P26W/840 HF-H PG CW3 | FBS120226840GC3 | 1   | 74       | 1,72         | 158,00     |

### Accessoires

| EOC | Type aanduiding   | Typenummer | MOQ | VRG code | Gewicht (KG) | Richtprijs |
|-----|-------------------|------------|-----|----------|--------------|------------|
| 4   | 66254100 GBS120 L | GBS120L    | 1   | 74       | 0,14         | 25,60      |
| 4   | 66251000 GBS120 P | GBS120P    | 1   | 74       | 0,10         | 18,80      |

# CoreLine SlimDownlight DN135B/DN135C



- Energiebesparingen en langere levensduur verlagen de bedrijfskosten
- Vervanger voor 2 x 18 W en 2 x 26 W CFL downlight-armaturen
- Gemakkelijk installeren dankzij insteekconnectors en uiterst kleine inbouwdiepte



De CoreLine SlimDownlight is een reeks ultradunne inbouwarmaturen die zijn ontworpen ter vervanging van tot 2 x 18 W en 2 x 26 W CFL gebaseerde downlight-armaturen. De aantrekkelijke totale eigendomskosten van het product maken het voor klanten gemakkelijk over te stappen naar LED's. CoreLine SlimDownlight levert een uniform lichtoppervlak-effect voor gebruik in algemene verlichtingstoepassingen. Hij levert ook onmiddellijke energiebesparingen en een veel langere levensduur; dat maakt dat hem tot een milieuvriendelijke oplossing die zijn geld waard is. Ze laten zich gemakkelijk installeren dankzij hun insteekconnectors en uiterst kleine inbouwdiepte.

- Versie: DN135B (Inbouw), DN135C (Opbouw)
- Optiek: wit
- Lichtbron: LED, 3000 K of 4000 K
- Systeemoutput: 1000 lm (LED10S) of 2000 lm (LED20S)
- Systeemvermogen:
  - LED10S: 13 W
  - LED20S: 28 W
- Levensduur: 50.000 uur (bij 70% lumenbehoud, L70B50, bij Ta 25 °C)
- Kleurtemperatuur: 3000 K of 4000 K
- Kleurweergave: Ra > 80
- Driver: LED driver standaard meegeleverd; powerfactor > 0,9
- Lichtregeling: Niet Dimbaar
- Elektrische aansluiting: standaard middels push-in connector
- Montage: inbouw, gatmaat 150 mm (LED10S), 200 mm (LED20S)



CoreLine SlimDownlight  
DN135B/DN135C

Afmetingen in mm.

## Bestelgegevens

| EOC        | Type aanduiding              | Typenummer      | MOQ VRG | Richtprijs code |
|------------|------------------------------|-----------------|---------|-----------------|
| 1 07042099 | DN135B LED10S/830 PSU II WH  | DN135B10830PSWH | 1 75    | 59,00           |
| 1 07043799 | DN135B LED10S/840 PSU II WH  | DN135B10840PSWH | 1 75    | 59,00           |
| 1 07044499 | DN135B LED20S/830 PSU II WH  | DN135B20830PSWH | 1 75    | 69,00           |
| 1 07045199 | DN135B LED20S/840 PSU II WH  | DN135B20840PSWH | 1 75    | 69,00           |
| 1 07046899 | DN135C LED10S/830 PSU II WH  | DN135C10830PSWH | 1 75    | 69,00           |
| 1 07047599 | DN135C LED10S/840 PSU II WH  | DN135C10840PSWH | 1 75    | 69,00           |
| 1 07048299 | DN135C LED20S/830 PSU II WH  | DN135C20830PSWH | 1 75    | 79,00           |
| 1 07049999 | DN135C LED20S/840 PSU II WH  | DN135C20840PSWH | 1 75    | 79,00           |
| 1 38117299 | DN135B LED6S/830 PSR-E II WH | DN135LED6S830   | 1 75    | 59,00           |
| 1 38119699 | DN135B LED6S/840 PSR-E II WH | DN135LED6S840   | 1 75    | 59,00           |