

CoralCare Controller

Software manual



PHILIPS

CoralCare software is designed to run on all Windows versions.

- Download the CoralCare software on www.philips.com/coralcare
- Connect the USB cable to the PC to connect with the controller.

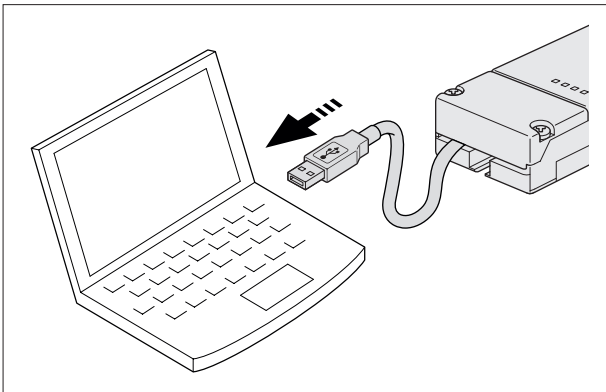

- Open the application and click on the message “not connected” in the bottom left-hand corner of the application.

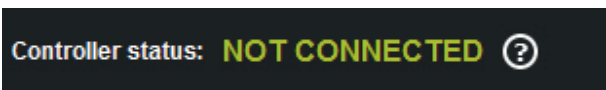

Alternatively, click on “device” in the task bar and then click on “open device” to go to the same device connection window. Select the controller and click on “connect”:

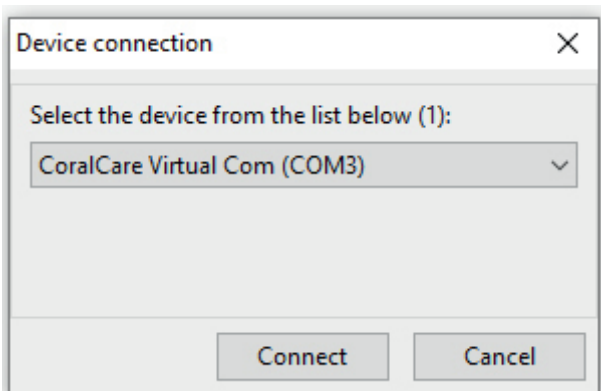

- You can load (pre)programmed settings from the controller by clicking on “load settings” at the bottom right-hand side of the application (next to “send to controller”) and clicking on “OK”.

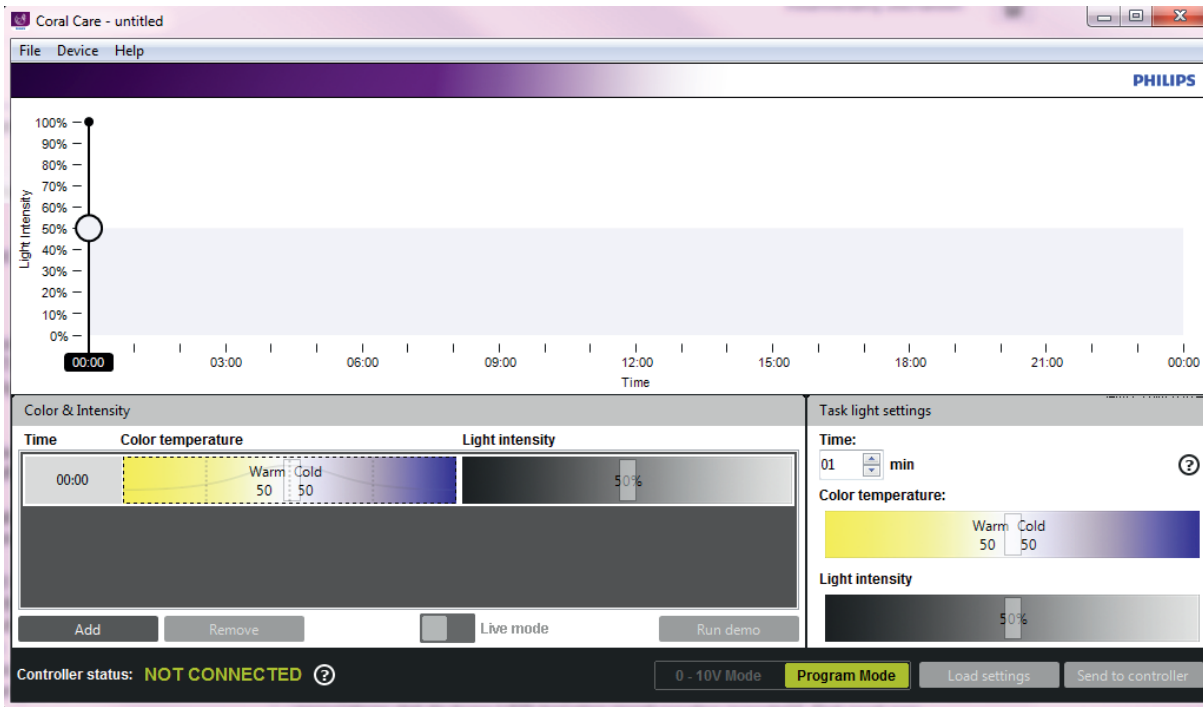

- In the default setting, the controller is programmed to work in the 0–10 V mode so it can be controlled by a 3rd party aquarium controller. By clicking on “program mode”, the controller can be used as a scheduler. The 0–10 V option can be reactivated at any time by clicking on 0–10 V and then clicking on “send to controller” to program this in the controller.



- When the application is started, it displays a blank screen with a single set point. You can now start building a custom 24-hour lighting schedule. Alternatively, you can load a default program (defined by Philips). This 24-hour schedule may be used as a base to determine your own settings. The standard program can be loaded by clicking on “device” in the taskbar and then selecting “load default settings”.

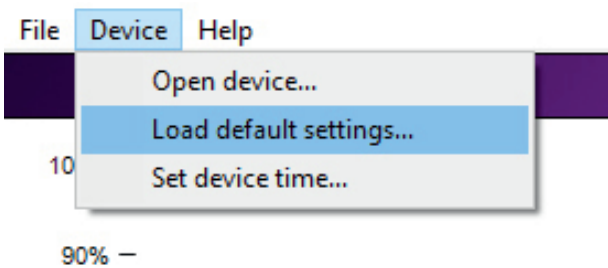

- Click on the “add” button to insert a new data point in your light schedule.

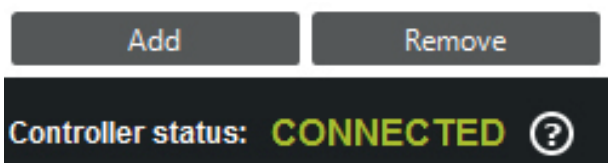

Explanation about data point settings:

- Time:** This is the time (in hours and minutes) at which the chosen light settings (color point and intensity) are active.
- Light intensity:** This determines the total intensity of the light. This is independent of the selected color-point.
- Color temperature:** Using the slider, you can define the color point of the light. It can be somewhere between a warm and a fully saturated blue color. The numbers “Warm 0-100” and “Cold 0-100” represent the percentage of power that is supplied to the two light channels.

For example:

If the color temperature slider is set in the middle and the light intensity is set to 100%, the color temperature variables show “100 warm and 100 cold”. This effectively means that both light channels are pushed to maximum light output.

If the light intensity is reduced to 50%, the color temperature variables show “50 warm” and “50 cold”. This effectively means that both channels are dimmed to 50% output.

If the color slider is set to the right and the intensity is set to 100%, the color temperature variables show “0 Warm and 100 cold”. This effectively means that the white channel is disabled and the blue channel is burning at 100%. Setting the intensity to 50% will result in the blue channel being dimmed to 50%.

Rounding

Whilst the color point and intensity are being selected the application calculates the percentage at which the two LED channels should be set. For both drivers this ranges between 1 and 100% (or “off”).

It is important to be aware that the application performs a rounding algorithm.

For example:

If the intensity is 100%

Warm is 4

Cold is 100

If the intensity is set to 25%

Warm will be 1

and Cold will be 25

If the intensity is lowered any further (for example 20%) the application will display

Warm = 0

Cold = 20

All values smaller than 1 will be automatically rounded to 0.

In this example, the white channel is therefore disabled.

- First define at what time you want the fixture(s) to switch on, and at what color point you want it to start. Set the intensity at 0% for the first point.

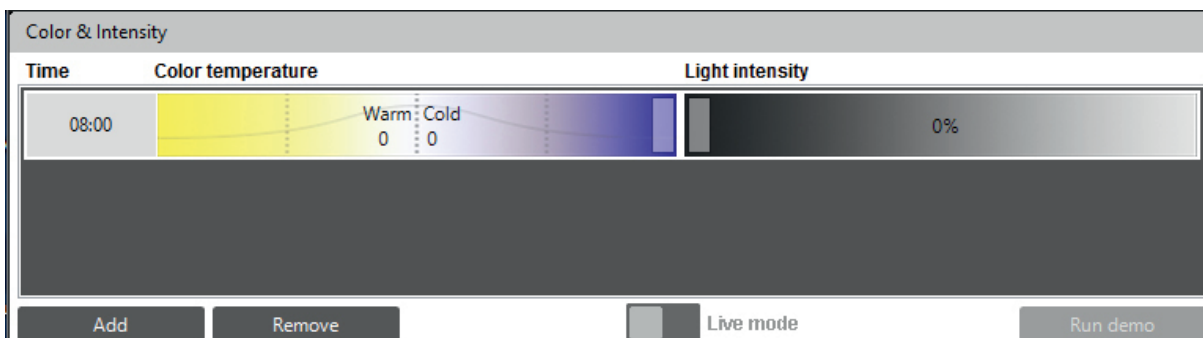

- Add a second point and again define time, color and intensity. The program will calculate all steps (time, color and intensity) between these points and make sure the change in settings runs smoothly.

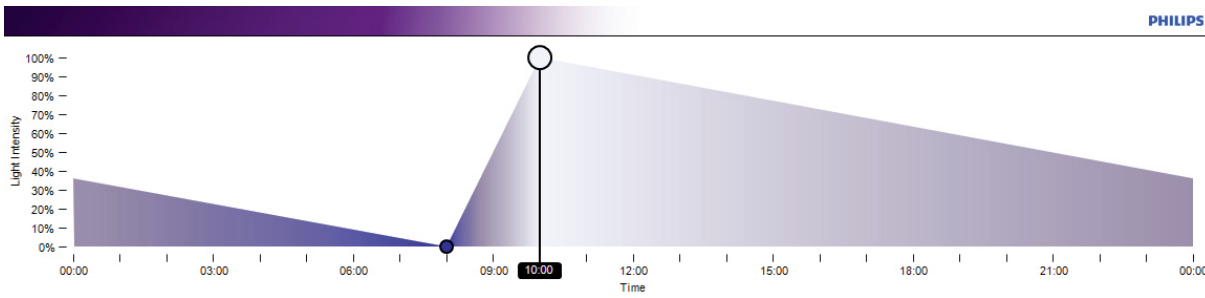

- Keep adding points until a complete day schedule has been defined. For example:

The screenshot shows a full day schedule with five points: 08:00 (0% intensity), 10:00 (80% intensity), 13:00 (100% intensity), 20:00 (80% intensity), and 22:00 (0% intensity). Below the graph is a control panel with a table for Color & Intensity settings.

Time	Color temperature	Light intensity
08:00	Warm: 0, Cold: 0	0%
10:00	Warm: 70, Cold: 80	80%
13:00	Warm: 100, Cold: 84	100%
20:00	Warm: 70, Cold: 80	80%
22:00	Warm: 0, Cold: 0	0%

Additional controls include: Task light settings (Time: 10 min, Color temperature: Warm 2, Cold 20), Live mode checkbox, Run demo button, and Controller status: CONNECTED.

- Points can be removed by selecting a point (the selected row will be highlighted when you click on it) and clicking on the “remove” button:

The screenshot shows the Color & Intensity control panel with a single point at 00:00. The row is highlighted, and the Remove button is active. The color temperature is set to Warm: 50, Cold: 50, and the light intensity is 50%. The Controller status is NOT CONNECTED.

- Once the program has been defined, the settings can be saved on the computer. This is done by clicking “File-> Save as”. This file can be shared with other reefers to show the setup of the 24-hour schedule.
- The settings have not yet been saved in the controller! The settings will be transmitted to the controller when you click on: “Send to controller”.

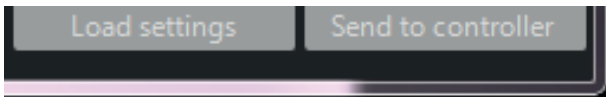

- The content of the controller can always be checked by clicking “load settings”. CAUTION: loading settings from the controller will overwrite all content that is currently displayed in the scheduler section. Make sure you save the old data on your PC before loading the settings in the controller.
- The controller has an internal clock that should be synchronized with the PC (and time zone). This is done via the menu “Device-> Set device time”.

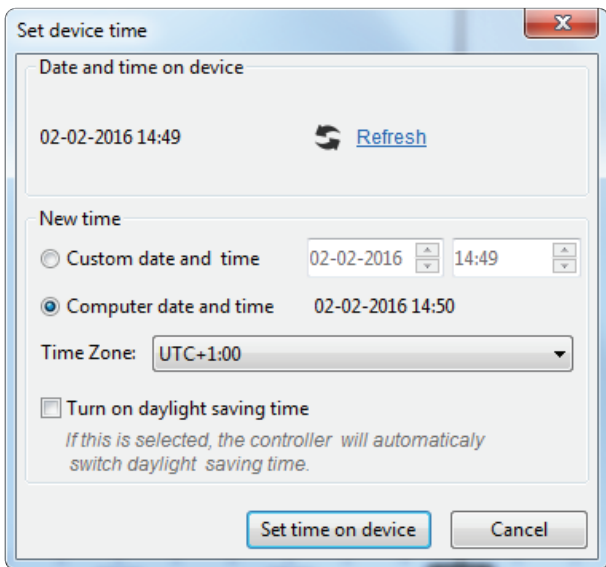

- Here a custom time can be set (“custom date and time”) or the current computer time can be set. Make sure you select the correct time zone so that the daylight savings option knows on what date to adjust for summer/winter time.”
- When all options have been selected, click on “set time on device”.

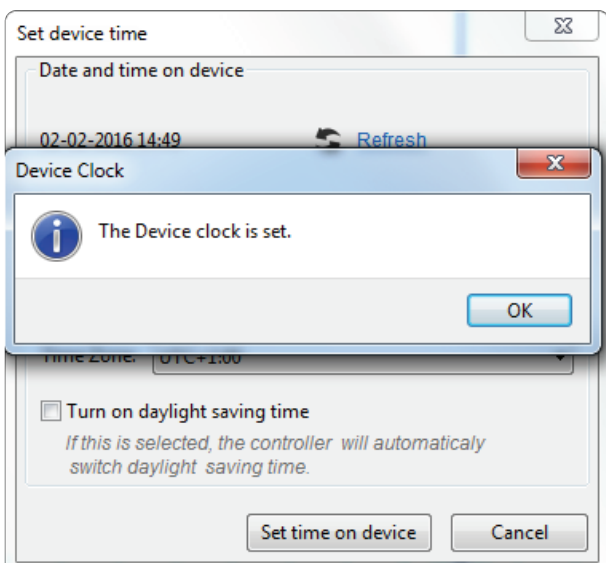

- If the luminaires are connected to the controller (and power is enabled), the “live mode” option can be used to experience the levels that are set in the scheduler application.



- With live mode enabled, the controller sends all data directly to the fixtures (for every entry). This starts when a time entry is selected. When a time entry is selected, the corresponding row (time, color and intensity) is highlighted and content is transmitted to the lamp. All changes in the highlighted area will be transmitted directly to the fixture(s).
- In addition to live mode, the controller also supports a demo mode. In two minutes, the program runs through the entire schedule and transmits the data to the luminaire.



- After the data has been saved and transmitted to the controller, the controller can be disconnected from the computer.

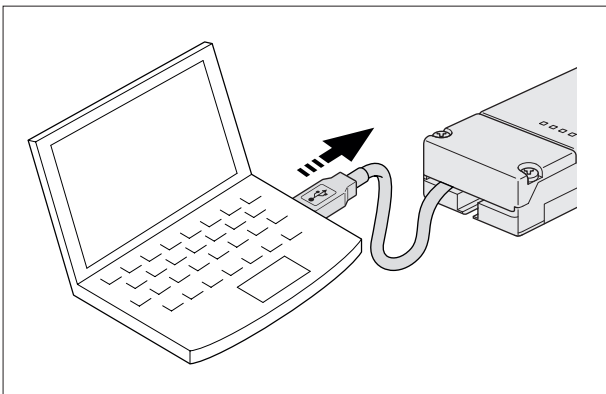

- Connect the USB cable to the USB power supply.

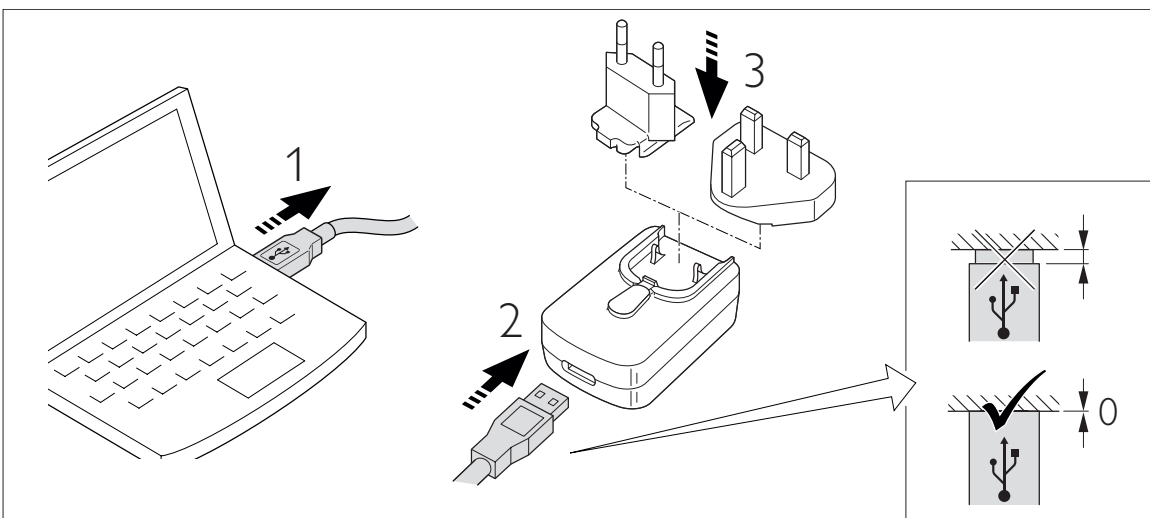

- Insert the power supply into the plug (the controller will automatically be enabled and operational).

Battery Backup

The controller holds a battery backup that will save the data and the time on the controller.

The 24-hour schedule data (time, color point and intensity) will be saved in the internal memory and will never be lost. The actual time will continue to be correct up to two days after disconnection of the power from the USB.

After two days, the time should be re-programmed via the PC application.

The internal clock of the device has a maximum deviation of 15 minutes a year.

We therefore recommend you re-program the time of the controller on a yearly basis.

Task Light Settings

The “*task light*” option can be set with the help of the PC application.

The “*task light*” setting is activated by clicking on the button on the CoralCare Controller.

The content of this setting is variable. Length (execution time), color point and intensity can be set. If you click on the “*task light*” button again, the controller will jump back to its regular program.

Make sure you click on “send to controller” when you change the variables for this option.

Task lighting can be used during tank maintenance or to quickly check the aquarium inhabitants at night.

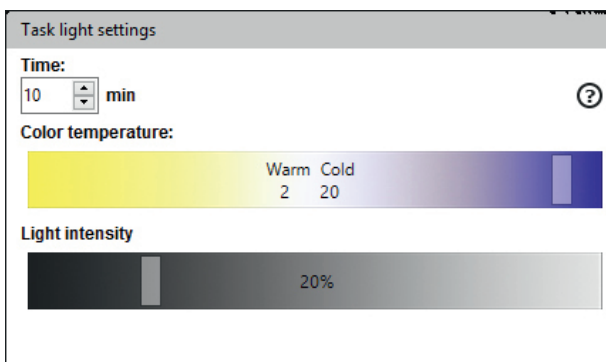

Disconnecting controller

If there is no communication between the controller and the fixture (no power on controller or communication cable disconnected from fixture), the fixture will go into a default state, with 100% light output.



Philips Lighting Contact Centre
Int. Business Reply Service
I.B.R.S. / C.C.R.I. Numéro 10461
5600 VB Eindhoven
Pays-Bas / The Netherlands

www.philips.com/coralcare
 +800 7445 4775

0000.000.00000
Last update: 17/05/16