



Design-in guide

Philips Lumiblade OLED Panel Brite Family

August 2015

PHILIPS

Contents

Disclaimer	4
Introduction to this guide	5
Documents required for a comprehensive information overview	5
Introduction to the Lumiblade Brite family	6
Commercial names and terms for Lumiblade OLED products	7
This guide	8
Safety and Warnings	9
Structure of an OLED and Brite FL300 interfaces	10
Mechanical integration	12
Integration aspects	12
General recommendations for Brite FL300 product family	12
Specific recommendations for integration level 1	14
Specific recommendations for integration levels 2/4	15
Assembly/handling notes	16
Cleaning instructions	16
Optical integration	17
Brite FL300 mirror versus standard finish	17
Integration levels 1 and 2 versus integration level 4	19
Types of optical elements	19
Scattering elements	20
Refractive elements	20
Absorbing elements	20
Shielding elements	20
Electrical integration	21
Driver selection	21
Additional details about OLED failure mode	22
Electrical wiring and contacting	22
Serial interconnection	22
Parallel interconnection	22
OLED identification	22
OLED current setting	24
Establishing electrical connections (soldering recommendations)	24
Cables	25
Assembly	26
Electrostatic discharge (ESD)	26
Thermal integration	28
Integration aspects	28
General remarks	28
Impact factors	30

Additional information	36
Tc.....	36
Moisture / humidity.....	36
Philips Lumiblade OLED Panel Brite FL300 and Lumiblade Drivers.....	37
Philips ESD support	37
Logistics data	38
Philips Lumiblade OLED Panel Brite FL300 ww family	38
Philips Lumiblade OLED Panel Brite FL300 wm family.....	39
Philips Lumiblade OLED Drivers	40
Mains driver, 8 output channels, TouchDim/DALI and analog control.....	40
Single channel low voltage drivers	40

DISCLAIMER

The information in this guide is accurate at the time of writing. This guide is provided “as is” without express or implied warranty of any kind. Neither Philips nor its agents assume any liability for inaccuracies in this guide or losses incurred by use or misuse of the information in this guide.

Philips will not be liable for any indirect, special, incidental or consequential damages (including damages for loss of business, loss of profits or the like), whether based on breach of contract, tort (including negligence), product liability or otherwise, even if Philips or its representatives have been advised of the possibility of such damages.

INTRODUCTION TO THIS GUIDE



Thank you for choosing a Philips Lumiblade OLED Panel Brite product. This guide provides the necessary information for integrating this panel into a luminaire.

This manual covers the whole Philips Lumiblade OLED Panel Brite family, including the low and high voltage driver versions. Extensions to the product family will be added to this guide in future updates.

Note: OLED technology is continuously being improved. For the latest updates, please go to: www.philips.com/technology.

Documents required for a comprehensive information overview

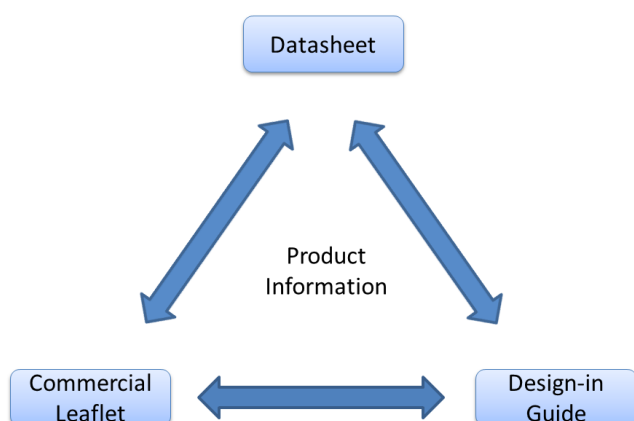

In order to provide information as clearly as possible, Philips has structured its product documentation in the following way:

- The leaflet contains commercial information about the product family
- The datasheet contains the product specifications
- The design-in guide describes how the product can be integrated into an original luminaire design.

These documents can be downloaded from the OEM website at: www.philips.com/technology.

For further information or support please contact Philips Lumiblade (see contact details at the end of the document).

INTRODUCTION TO THE LUMIBLADE BRITE FAMILY

The Philips Lumiblade OLED Panel Brite product family features efficient and high-brightness OLED panels at various integration levels and surface finishes. Additional color temperatures, light output levels and sizes will follow. Additionally, Philips Lumiblade provides dedicated driver electronics to enable easy integration.

The first available OLED panel of the Brite family, the Brite FL300, comes in three different integration levels enabling various functional OLED lighting applications. The introductory products are offered in a single square and rectangular format and a warm white configuration. Different color temperatures and sizes will follow.

Product	Integration Level	Product code
Lumiblade OLED Panel Brite FL300 ww N	1	925400009400
Lumiblade OLED Panel Brite FL300 ww N w/o Rset	1	925400011400
Lumiblade OLED Panel Brite FL300 ww A0	2	925400009500
Lumiblade OLED Panel Brite FL300 ww BI PCAL	4	925400009600
Lumiblade OLED Panel Brite FL300 wm N	1	925400012500
Lumiblade OLED Panel Brite FL300 wm A0	2	925400012600
Lumiblade OLED Panel Brite FL300 wm BI PCAL	4	925400012700
Lumiblade OLED Panel Brite FL300 L ww N w/o Rset	1	925400013200
Lumiblade OLED Panel Brite FL300 L ww A0	2	925400013300
Lumiblade OLED Panel Brite FL300 L wm N w/o Rset	1	925400012900
Lumiblade OLED Panel Brite FL300 L wm A0	2	925400013000

Table 1 - products in the Brite FL300 family

Different types of dedicated drivers are available featuring different supply voltages as well as single and multiple output channels. Various interfaces (DMX, DALI, analog, TouchDim) allow a high level of flexibility in the design of all kinds of luminaires and lighting applications.

Product	Supply voltage	Output channels	Product code
Driver D230V 80W/0.1-0.5/1A/28V TD/A 8CH	120, 220-240, 277 V AC	8	925400010200
Driver D024V 10W/0.1A-0.4A/28V D/A	24 V DC	1	925400010100
Driver D024V 10W/0.1A-0.4A/28V DMX	24 V DC	1	925400012000

Table 2 - products in the Lumiblade driver family

Commercial names and terms for Lumiblade OLED products

The Brite product family comprises OLED and driver components. The product names and terms are explained below:

Philips Lumiblade OLED Panel Brite FL 300 ww BI PCAL

Lumiblade	technology name
OLED Panel	light source
Brite	denotes the product family: - <i>Brite</i> = <i>functional lighting</i>
FL	denotes the main usage: - <i>FL</i> = <i>functional lighting</i>
300	technology level
L	long/ rectangular version
ww	denotes color temperature and surface finish: - <i>ww</i> = <i>warm white standard finish</i> - <i>nw</i> = <i>neutral white standard finish</i> - <i>wm</i> = <i>warm white mirror finish</i> - <i>nm</i> = <i>neutral white mirror finish</i>
BI	letters reflect integration level, numbers reflect version diversifiers per integration level: - <i>N</i> = <i>integration level 1</i> - <i>A</i> = <i>integration level 2</i> = <i>integration level 1 + cable + back-plate</i> - <i>B</i> = <i>integration level 4</i> = <i>integration level 2 + front housing frame</i>
PCAL	housing material / color: - <i>PCAL</i> = <i>polycarbonate/aluminum look</i>

The product names and terms of the Philips Lumiblade OLED Driver family are explained below:

Philips Lumiblade D024V 10W 0.1-0.4A 28V D/A

D024V	input voltage of the driver
10W	maximum power supplied on output side
0.1-0.4A	range of current available on output side
28V	maximum voltage supplied on output side
D/A	dim protocols (separated by '/'), when applicable: - <i>D</i> = <i>DALI</i> - <i>A</i> = <i>analog</i> - <i>DMX</i> = <i>DMX</i> - <i>TD</i> = <i>TouchDim (including DALI)</i>
8CH	number of output channels

This guide

This design-in guide provides the necessary guidelines for configuring the Lumiblade OLED Panel Brite products into a system to meet customer needs. The OLED Panel Brite family is designed to enable all types of OLED based luminaires in functional indoor lighting.

The following sections cover

- safety and warnings
- OLED structure and interfaces
- mechanical integration guidelines
- optical integration guidelines
- electrical integration guidelines
- thermal integration guidelines

This guide is divided into six sections although many aspects are interrelated. We advise reading through all sections before beginning a luminaire design in order to understand how various aspects are interrelated, and to get the best out of the Brite FL300 family products.

SAFETY AND WARNINGS

All products of the Philips Lumiblade OLED Panels Brite family meet the requirements of IEC 62868 (draft) and UL 8752 and are intended for integration into luminaires. Details are provided in the relevant product datasheets. OLED panels are class III electrical appliances (in accordance with IEC 61140, IEC 60598-1) with accessible conductive parts. These parts require adequate insulation, provided, for example, by SELV/UL class 2 power supplies and the luminaire housing. The luminaire design must follow standards appropriate for the intended use of the luminaire, e.g. UL 1598, UL 153, UL 2108 and/or IEC/EN 60598.

Luminaire design should account for an increase in OLED voltage over life. Data is provided in the relevant datasheets. The safety standard requirements must also be fulfilled at these increased voltages.

In rare circumstances, OLED panels may fail due to a low-resistance conductive path within the light-emitting area ('internal short circuit'). In this case heat (temperature may locally exceed 70 °C) will be generated at the location of the internal short circuit due to the residual resistance. The luminaire design must take this into account by providing adequate safeguards. Dedicated OLED drivers with built-in internal short circuit protection are available and are strongly recommended. Short-circuit-proof control gear in accordance with IEC 61347-1 does not automatically fulfill the requirements for OLED internal short circuits.

OLED panels are fragile components made of glass. They must be integrated into the luminaire so that all parts of the panel are reliably secured to the end product and cannot become loose. The glass parts of the OLED panel must be installed so that splinters cannot cause harm to the user in the event of breakage. Please use gloves at all times when handling the Philips Lumiblade OLED Panel Brite FL300 products in order to avoid fingerprints or potentially sharp edges.

Defective OLED panels or panels with visible damage must not be used. Damaged OLED panels should be disconnected from the power supply and must be either disposed of or returned to the manufacturer. OLED panels are not user serviceable.

Do not...

- ... bend the OLED
- ... twist the OLED / integrate the OLED so that torsion occurs at either room or other temperatures
- ... apply point loads to either the front or back of the device
- ... write on the device with a pen or similar implement
- ... expose the device to high temperatures
- ... use defective products
- ... use products that have been dropped, even if there is no visible alteration
- ... use products that something has been dropped upon, even if there is no visible alteration

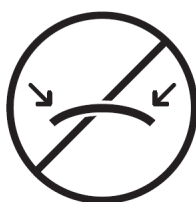

Do not bend



Do not twist



Do not press

STRUCTURE OF AN OLED AND BRITE FL300 INTERFACES

The following gives a brief description of the Brite FL300.

OLEDs consist of various layers of organic semiconductor material sandwiched between two electrode layers. At least one electrode layer is transparent. When voltage is applied to both electrodes, positively and negatively charged holes and electrons are injected into the layer stack. When those recombine they initiate a process that generates light. This happens everywhere between the two electrodes, so the entire area lights up. This is a fundamental difference between OLEDs and conventional light sources, which generate light in a limited area (e.g. point or line sources).

As they are very sensitive to humidity, the functional layers have to be hermetically sealed to prevent defects caused by moisture or other particles, which would terminate the operation of the device.

The degree of conversion of electrical energy into light defines the efficiency of the OLEDs. Typically, a certain amount of energy is also transformed into heat. Temperature needs to be kept at a similar level over the device's entire active area (area of light emission) as this affects the operation of the device (described in more detail in the related sections below). Hence, the Brite FL300 has a heat spreader fitted to the back of the device.

The illustrations below show the principle structure of the Brite FL300. A transparent anode layer is applied to the back of a transparent substrate made from thin glass. This is followed by a set of organic layers and a metallic cathode which also acts as a reflector. Thin-film encapsulation (TFE) is applied to the back of the cathode. The heat spreader made from a thicker metal foil is attached to the encapsulation layer.

The Brite FL300 is available in three different integration levels. Figure 1 shows the very basic integration level 1 on the left. Two higher integration levels are offered as well, based on the level 1 setup (integration levels 2 and 4). Integration level 2 is shown on the right.

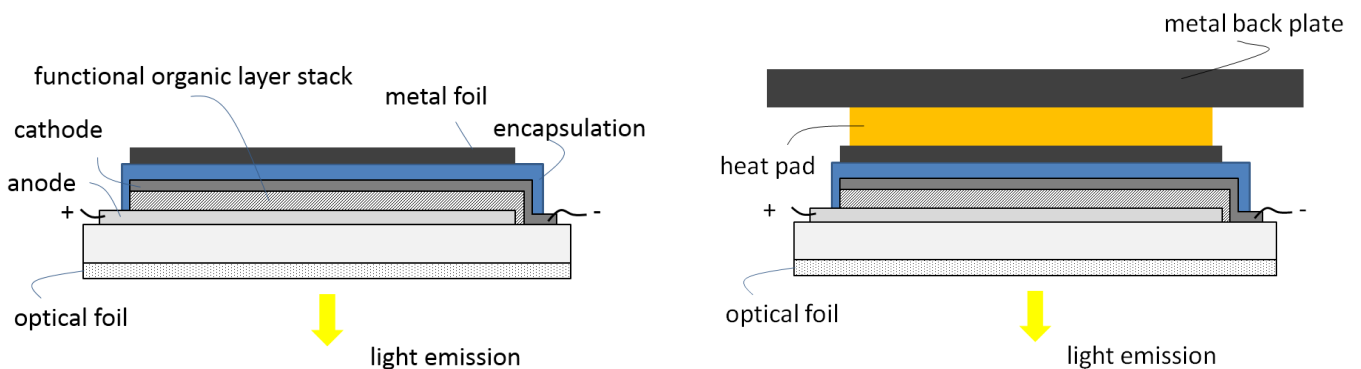

Figure 1 - schematic representation of the different Brite FL300 ww integration levels (left: integration level 1, right: integration level 2)

Integration level 2 is based on integration level 1 with an additional thermal conductive heat pad on the metallic foil. A black aluminum metal back-plate is attached to the heat pad that improves heat dissipation through radiation. Notches in the back-plate are provided to enable the plate to be mounted with screws.

Integration level 4 is based on integration level 2 with an additional housing frame on the front.

Comparing integration level 1, levels 2/4 have a slightly different electrical and optical performance due to the metal back-plate (potentially reduced temperature). The housing frame of integration level 4 shields an insignificant amount of light output.

Three interfaces need to be considered:

- Thermal/mechanical interface:
the back of the OLED acts as a thermal and mechanical interface. The back of integration level 1 is made of a thin metal foil which acts as a heat spreader while the backs of integration levels 2/4 consist of a metal back-plate (see Figure 1).
- Optical interface:
the OLED glass front acts as an emission 'window' and performs the function of the substrate on which the OLED is built. It provides a certain (limited) stability to the module but must not be used as a mechanical interface. An optical foil is attached to the glass front of the Brite FL300 ww types to improve the extraction of light and the color over angle stability.
- Electrical interface:
the electrical interface for integration level 1 comprises a PCB frame attached to the substrate. The electrical interface for integration levels 2/4 comprises a 5-wire cable with a Molex Picoblade plug.

MECHANICAL INTEGRATION

The Philips Lumiblade OLED Panel Brite FL300 product range incorporates the newest lighting technology to combine bright, homogeneous lighting with a super-thin and sleek product appearance. This enables the design of unique, innovative and functional luminaires. Several mechanical and handling aspects arise due to the special characteristics of the OLED Panel Brite FL300 product family.

With an extreme thinness of 1.4 mm to a maximum of 3.00 mm, the light panels demand careful handling. To achieve this the light panels are based on thin glass encapsulated by thin-film encapsulation making them electronic components sensitive to mechanical impact and e.g. ESD. In order to guarantee optimal operation, the panel may not be altered by any means (torsion, pressure, bending, electrical connections, etc.). Awareness of the potentially sharp glass edges and metal back-plate (applicable only to integration levels 2/4) is also advised.

Integration aspects

When designing a luminaire with a Brite FL300 product please ensure that the following aspects are considered.

General recommendations for Brite FL300 product family

Point loads: Please prevent exerting point loads on the OLED light source of your luminaire. Point loads of 4N applied with a round shaped tip with a 0.25 mm radius can lead to local damage on the back. This can be caused e.g. by forces to both the light emitting front or the encapsulated back.

Solder joints can locally increase the thickness of the light source and may result in point loads when mounted or temporarily placed into flat, rigid constructions. Figure 1 on page 14 shows how particles or locally increased thicknesses may lead to point loads and/or deformation.

Scratching: Please avoid any type of scratching (e.g. with a pen), pressure or other temporary forces on the light source as this can also result in temporary, local point loads and may damage the product.

Environmental conditions: The Brite FL300 product family is designed to operate optimally in indoor luminaire applications as defined in the product datasheet. Any usage outside the recommended environmental conditions, including high humidity, contact with water or dew, can lead to the product's damage and malfunction. Suitable protection is therefore necessary to help guarantee the product's reliability.

Mechanical fixation: Brite FL300 products are designed to be mechanically fixed into luminaire housing units. Due to the fragility of the components the mechanical interfaces need to be designed with care. Please consider the following recommendations:

- Avoid clamping or any other mounting methods that create local forces that may damage the light source.
- Design the mounting structure so that it provides additional stability to the fragile light source. Do not design a mechanical fixture that holds the light source with a single touch point.

- The electrical wires are not meant to be used for mechanical fixation and must not be exposed to pulling forces of any kind as no strain relief is provided by the product.
- The use of glue (for all integration levels) or screws (applicable only to integration levels 2/4) is recommended for mounting OLED Panel Brite FL300 products to luminaire housing units.

Glue

Gluing is a recommended mounting option for all Philips Lumiblade OLED Panel Brite FL300 products. However, any formation of local forces needs to be avoided.

The glue and thin-film encapsulation need to be chemically compatible. Common adhesives based on epoxy, solvent free urethane, acrylic and vinyl are generally suitable. Specific adhesives can be used according to requirements of flexibility, impact strength, and thermal conductivity. Chemical compatibility of the thin film encapsulation with different types of glues depends significantly on the composition and type of curing/hardening/post processing of the adhesive. This can be generalized but not limited to the following criteria:

- Adhesives should be solvent-free to ensure the compatibility with TFE organics
- If adhesives are processed at a higher temperature (e.g. to induce a chemical reaction or as hot melt) the processing temperature should be as low as possible and must not exceed 85 °C for max 15 min.

Avoid any type of glue that shrinks or creates heat during curing or drying as this may result in damage to the light source.

Please ensure that almost the entire area of the metal foil is covered when applying glue to the back of the light source (avoid formation of bubbles or other contamination). This provides safe mechanical mounting and a homogeneous thermal interface (see section on thermal integration on page 27). Avoid gluing the PCB and local gluing as this may result in pull or push forces and point loads. Limit glue application to the area covered by the metal foil taking special care to avoid the glue getting under the metal foil or having contact with the encapsulation and glue below the foil.

When using glue on the front of OLED Panel Brite FL300 products, the chemical and mechanical compatibility of the glue with the surface of the optical¹ foil on the light source also need to be ensured. Please refer to Figure 1 which shows the location of the foil. It is attached to the OLED panel primarily for optical performance, and the glue is designed to hold the foil for life of the product. It may not be able to withstand the mechanical forces exerted by a housing or other mounting component glued to its surface.

¹ Only Brite FL300 ww types include an optical foil to enhance the extraction of light and improve color over angle.

Screws

Screws are another recommended mounting option for integration levels 2/4. In order to avoid bending or delamination of the housing frame while mounting the OLED Panel they should not be over-tightened. Please check for deformation of the back-plate.

Only use fitting screw positions as shorter distances between screws (see datasheet) can stress the light source and may lead to damage. Do not use counter-sunk screws because this may also lead to lateral stress on the back-plate and thus damage the OLED.

Use only flat mounting parts; particles, bent and bendable surfaces will lead to point loads, torsion or bend the light source which can cause damage.

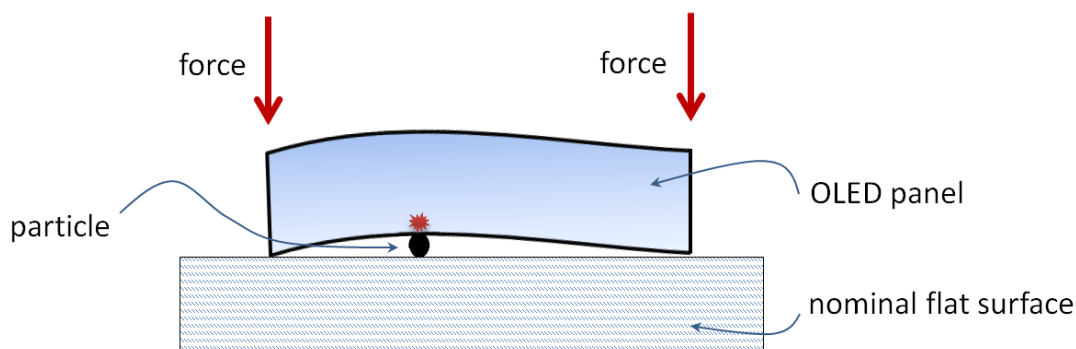

Figure 2 - example of unintended bending due to particles and force to the front

Depending on the mounting surface, insulation may be necessary in order to prevent electric short circuits near the solder joints.

Specific recommendations for integration level I

The Philips Lumiblade OLED Panel Brite FL300 integration level I is optimized to enable sleek, virtually seamless luminaire designs. However, special attention should be paid when designing mechanical fixation. This integration level is particularly sensitive to mechanical impacts such as:

- point loads resulting from forces from either side, including front edges caused by a housing unit or frame
- (local) stress to any component of the device
- any force on the soldering pads
- tension due to torsion or bending caused either by the luminaire design or by non-matching CTEs² of mounting materials and OLED panel

Please provide a gap between the PCB and the mounting component of your luminaire (a distance of 0.2 mm is recommended) to avoid any kind of torsion or bending of the light source. Note that the versions comprising R_{set}/R_{win} components require an additional 0.6 mm).

² CTE – coefficient of thermal expansion

The luminaire design needs to provide the light source with a good thermal interface (see section on thermal integration on page 27).

Example solution

A solution involving the aspects mentioned above is given in the following:

The Brite FL300 integration level I can be glued to a flat surface preferably with a heat pad to improve the heat dissipation. Standard double-sided adhesive can also be used although it may lead to reduced thermal performance.

Assembly: Particles or contamination caught in the glue applied to the metal foil of the OLED panel may cause point loads and damage and should be avoided. The glued area should be slightly smaller than the metal foil (see Figure 5). Localized contact should also be avoided. The PCB frame of the light source needs to be kept free of any fixation material.

Heat pads or double-sided adhesives with sufficient thickness should be used due to the difference in thickness between the PCB area and the active, light emitting area (refer to the product datasheet). 3M TM-672SA with a thickness of 0.5 mm is recommended. Alternatively, the luminaire's mounting surface should be designed to compensate for the difference in thickness, ensuring a required gap of 0.2 mm between PCB and mounting surface.

A practical example taking all mentioned aspects into consideration is incorporated into the design of integration levels 2/4 (see Figure 1).

Specific recommendations for integration levels 2/4

The Brite FL300 products for integration levels 2/4 come with a metal back-plate and cables for improved robustness and easier mechanical and electrical integration.

The following aspects need to be considered:

- prevent point loads from either side including front edges caused by a housing unit or frame
- avoid localized stress to any component
- avoid tugging forces on the cables
- avoid repeated movement of cables which could cause them to break near the soldering points

Integration levels 2/4 are both able to be mounted to a flat surface with four screws. The screw notches are located in the corners (please refer to the technical drawings in the product datasheet). Special care has to be taken in choosing the correct screws (no counter-sunk screws) and precise screw pitch to prevent mechanical stress to the housing.

Assembly/handling notes

Most of the recommendations below are directly related to the requirements discussed above.

Do's

Please use gloves at all times when handling the Philips Lumiblade OLED Panel Brite FL300 products in order to avoid fingerprints or potentially sharp edges.

Don't's

When mounting Philips Lumiblade OLED Panel Brite FL300 products into the luminaire avoid bending, torsion or pulling forces (e.g. when removing protection foils) which may cause damage to the OLED.

Please also avoid any kind of point loads caused, for example, by writing on the product with a pen.

Do not scratch the light source with any hard or sharp objects.

Do not drop the light source and do not let anything fall on top of it. Discontinue use of the product if this happens, even if there is no visible alteration.

Defective OLED panels or panels with visible damage must not be used.

Cleaning instructions

Please avoid scratching the front glass with any hard or sharp objects. Do not use any other chemical than isopropanol or ethanol to remove stains and fingerprints. OLEDs can be cleaned with any soft textile.

For everyday cleaning, the use of a compressed air de-duster is recommended. Should fingerprints or more persistent contamination have occurred, isopropyl alcohol should be applied to a lint-free cloth. Apply a little of the liquid to the cloth and gently wipe the surface of each OLED with a circular movement, beginning at the center and moving towards the edge. Never use water on the OLEDs as this may shorten the lifetime or reliability of the product.

OPTICAL INTEGRATION

In contrast to all other light sources, OLED technology provides diffuse and homogeneous light emission. The light source can be used to distribute the light without additional optical means, which reduces losses in efficiency in optical systems. The Philips Lumiblade OLED Panel Brite product family thus enables extremely thin luminaire designs with homogeneous light emission.

Luminaire designs or lighting applications using the Brite FL300 may include the integration of other optical elements, be it for aesthetical reasons, safety or to intentionally alter the optical performance (e.g. color). These alterations can affect the performance of color, luminance, efficiency, and angular dependency of color and luminance.

This section shows the effects that need to be considered when integrating additional optical elements. It is not intended to provide quantitative dependencies for a combination of optical elements.

Brite FL300 mirror versus standard finish

The Lumiblade OLED Panel Brite FL300 is available with two different types of surface finish:

- standard finish – diffuse reflecting surface (ww and nw types)
- mirror finish – glossy surface (wm and nm types).

Brite FL300 products in standard finish feature an optical foil with diffusive properties on the light emitting side. This foil increases the light output and optimizes color over angle to a greater extent than the Brite FL300 mirror finish type. Due to this foil it has a matte white surface when not in use. The mirror finish does not have an additional optical foil and the surface is glossy and highly reflective in the light emitting area when not in use.

Figure 3 shows the effect of the optical foil as an example of an optical element. Luminance is shown as a function of the viewing angle³ for both versions of the Brite FL300, with and without foil. Figure 4 shows the difference in the color over viewing angle.

³ The viewing angle is measured between the surface normal and the direction of light.

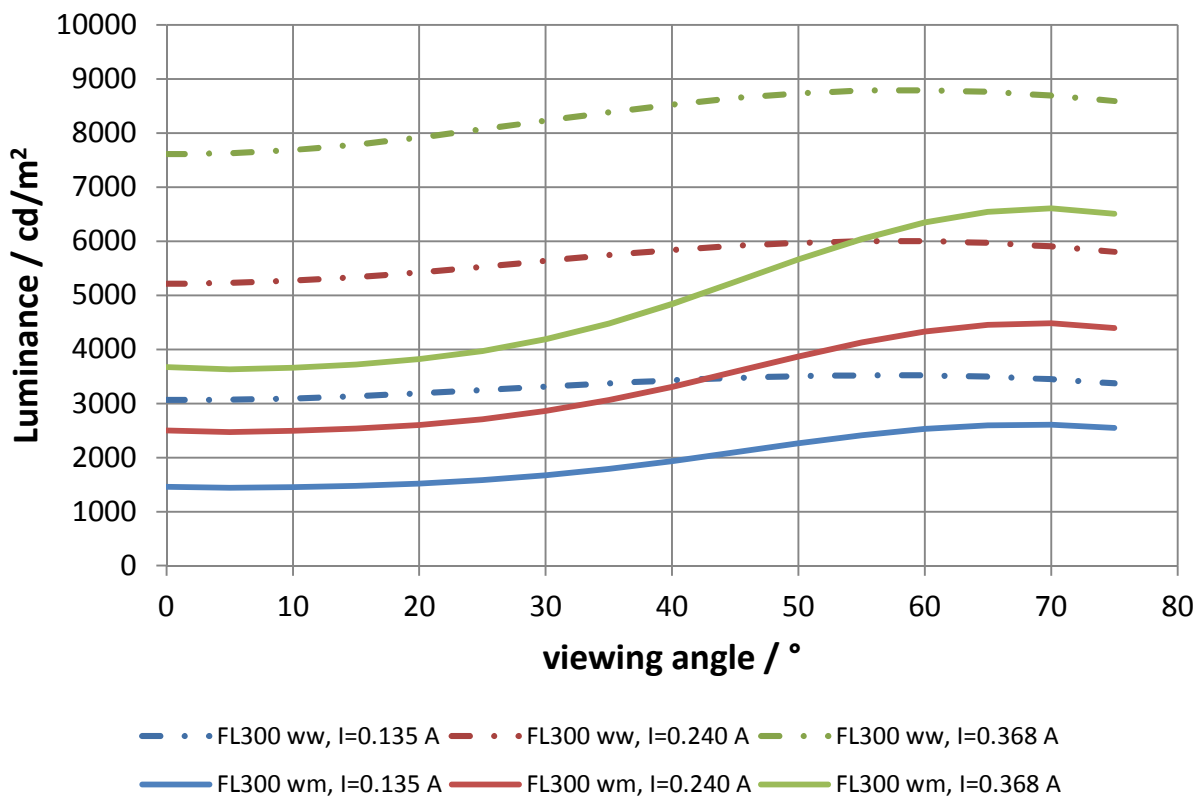

Figure 3 - Brite FL300 ww vs Brite FL300 wm : luminance versus viewing angle

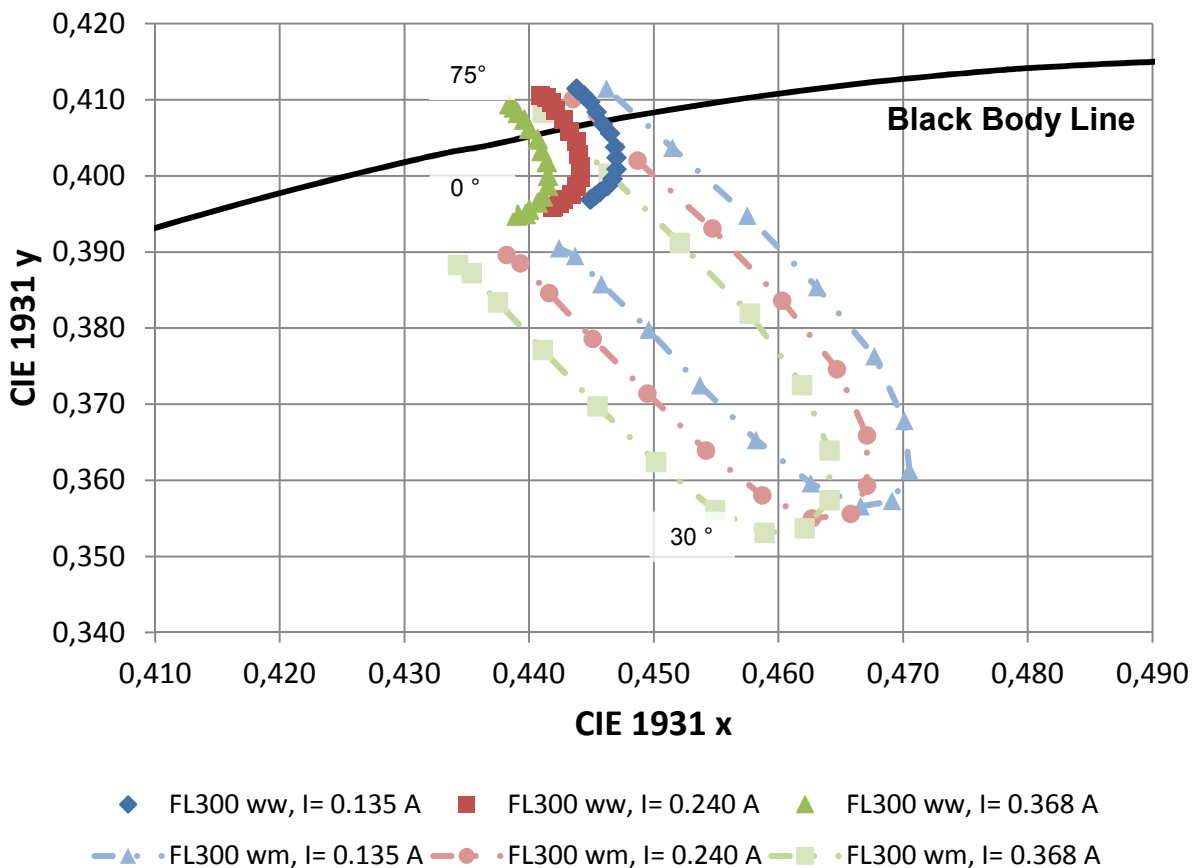

Figure 4 - Brite FL300 ww vs Brite FL300 wm: color versus viewing angle

A complete dataset in IES and EULUMDAT formats for each of the modules mentioned in Table I on page 6, operated at different driving currents can be downloaded at www.philips.com/technology.

Integration levels 1 and 2 versus integration level 4

OLED Panel Brite FL300 products primarily emit light from the front. However, a small portion of generated light also escapes from the device at the glass edges due to wave guiding effects inside the glass substrate. This light emitted from the edges is not as white as the light emitted from the front. Integration levels 1 and 2 emit light at the edges of the panels. If this light emission is not desired in the targeted application appropriate countermeasures to shield the light need to be considered in the design. The glass edges of Brite FL300 integration level 4 products are covered by a non-transparent front housing frame so that no light is emitted at the edges.

Types of optical elements

Luminaire manufacturers are free to integrate additional optical elements in order to optimize performance with respect to the requirements of the specific application. Properties such as beam shape, efficacy, luminous flux, color point, color rendering, color over angle and appearance when not in use can be adjusted by applying additional optical elements.

Please note that the direct attachment of additional optical elements by optical gluing to the diffusor foil could significantly alter the scattering properties of the standard foil of the panels with a standard surface finish.

A small gap left between the panel and the optical element can limit these changes. However, the interfaces towards the gap may also generate losses due to the difference in refractive indices. A possible solution is offered by optical elements with anti-reflective surfaces which can minimize optical loss at the additional surfaces created by the gap.

Optical elements can be mounted on panels with the mirror surface finish with either optical glue⁴ or a small gap in front of the panel. Careful matching of refractive indices at the interfaces is recommended to optimize the optical efficiency when attaching optical elements to the surface directly. For example, unsuitable glue used to apply the optical element may have a lower refractive index than glass and result in undesirable wave guiding.

Combining different optical elements is possible but interactions (see below for different types of optical elements) have to be considered in the individual design.

During assembly, inclusions (air bubbles, dust or other contamination must be avoided as they will remain constantly visible and may also alter the performance of the optical element. Please also refer to the precautions in the section on mechanical integration (see page 12).

⁴ We define 'optical glue' as a glue that is primarily selected for its optical properties. Optical glue should solely provide adhesion and not alter the optical performance of a design.

Scattering elements

Scattering elements can be attached to tune the light extraction or the stability of color over angle. They are not suitable for concentrating the light; they can only be used for diffusing it. The non-light-emitting area of an OLED panel or the active areas between an array of panels can be concealed by spreading the light with a scattering element. Scattering elements are available as foils or plates. Plates add to the overall thickness of the luminaire design but can improve robustness.

Panels with the standard surface finish come with a scattering element in the form of a diffuser foil attached to the glass surface of the OLED panel using an optically clear adhesive (OCA), see Figure 1. This version of the Brite FL300 is optimized for high light output and minimal color change over angle.

Refractive elements

Refractive elements similar to optical plates with dedicated structures can be applied in order to control and/or narrow the beam shape. Leaving a gap between the optical plate and OLED panel is recommended for this purpose.

Refractive elements like foils with micro-structured surfaces or optical plates can be attached directly to the surface of OLED mirror surface panels (e.g. the Brite FL300 wm versions) to improve the light output. Refractive elements cannot be used to improve the stability of color over angle. Refractive elements can also be used together with scattering elements (taking the recommendations mentioned above into account).

Absorbing elements

Similarly to colored transparent plates, foils or semitransparent printed layers, absorbing elements can be applied to the front of the OLED to tune the emission color and the color-rendering index. These elements all have the intrinsic drawback of reducing the overall luminous efficacy of the system.

Shielding elements

Next to beam shaping with refractive elements, glare reduction can also be achieved by the attachment of optical shielding (with lamellas or raster configurations as used in TL luminaires). However, this option can result in low system efficiency and increased thickness to the luminaire depending on the material attached

If an application requires precise limitation or a customized structuring of the light emitting area, optical shielding can be applied parallel to the panel surface. Shielding elements such as nontransparent foils, printed layers or sheets are suitable in this case.

ELECTRICAL INTEGRATION

This chapter introduces basic concepts on how to integrate Brite FL300 panels into a luminaire with respect to driver selection, electrical wiring and contacting recommendations.

Driver selection

Dedicated Philips Lumiblade OLED drivers are recommended because they meet all the requirements given in the list below:

1. Current control is recommended
Current control offers the most stable way of powering OLED panels due to the OLED current-voltage characteristic and the relationship between luminous flux and current.
2. Output current ripple should be low
The DC current should have a low ripple. High current ripples could lead to inhomogeneity within the OLED, as well as to reduced lifetime and reliability. Typically, switch mode power supplies require a current ripple running through the current sense feedback resistor to work properly. Small ripple values are acceptable. A safe measure would be to keep the peak-to-peak value of the ripple below 30% of the mean value.
3. Avoid transient overshoot
When turning OLED and power supply on and off and due to other transient conditions, e.g. PWM switching, voltage and current overshoots may occur. These overshoots should be avoided and kept as low as possible. A soft start is recommended.
4. Take varying OLED voltage into account
The forward voltage of an OLED may vary due to forward current, ambient temperature and self-heating. Additionally, the forward voltage will increase during nominal operational lifetime. Forward voltage data are provided in the OLED panel datasheet.
5. Provide Short Circuit Protection (SCP)
Be aware that if the OLED fails the device may become much hotter locally at same current than in normal mode. In this case the OLED panel should be turned off. This can be done with dedicated OLED short circuit protection in the driver.
6. End of Life (EOL) protection is recommended,
The driver output voltage increases over lifetime of the OLED in constant current mode. The higher voltage leads to higher power consumption at constant current and hence to higher temperatures. A voltage limiter is recommended for the protection and safety of the driver and OLED.

A list of available Lumiblade OLED drivers can be found at the beginning of this document (see Table 2). Drivers are available for single and multi-channel outputs as well as for mains and 24 V supplies. All drivers comprise a variety of possible control protocols such as DALI, TD, DMX.

In addition to the guidelines above, please ensure that your application design maintains current, voltage and power within the specified range in order to help protect the OLEDs even in case of misuse of the

luminaire, e.g. powering with wrong voltage settings or in fault conditions that exceed the limits given in the datasheet. Both may lead to safety risks or damage of the OLED.

Additional details about OLED failure mode

In contrast to most other light sources OLEDs can go into a short condition when they fail. In this case a low ohm bypass between the anode and cathode is formed. While the light output may be reduced or even zero, current may still flow through the OLED. Due to the reduced resistivity the OLED voltage drops to a lower value.

If current is still applied to the OLED it may result in a local hotspot, i.e. the OLED temperature may locally exceed 70°C. If this happens the current through the OLED must be turned off.

The Lumiblade OLED drivers automatically detect this failure mode and turn the output off.

Electrical wiring and contacting

OLEDs can only be operated at DC current and in a forward direction. Reverse polarity may damage the product.

Serial interconnection

Technically, OLEDs can be connected in series. In practice, certain safety standards and regulations need to be taken into account:

- Connecting multiple OLEDs in series requires a higher output voltage from the driver. If voltages become higher than the safety extra low voltage limits (SELV) additional precautions are necessary.
- Short circuit protection is necessary for individual OLEDs and this can be difficult to implement. Alternatively, the complete series must be switched off if just one OLED fails.

Please note that Lumiblade OLED drivers are constructed in a way to deal with one OLED per output channel.

Parallel interconnection

We strongly advise not connecting OLEDs in parallel. This may result in asymmetrical current distribution to the OLEDs and lead to the damage of individual OLEDs. The safety aspects mentioned for general use and serial interconnection still apply and are even harder to implement technically.

OLED identification

Brite FL300 products incorporate two resistors (R_{set}/R_{win}) that encode the driving current and the output voltage window, which ensures that the proper lumen package is provided and working failure mode detection. This encoding guarantees that future product updates fit seamlessly into your application and provide the targeted lumen package without further changes. Note that the drivers need to support this.

The five-wire flat cable connects both the resistors and electrodes of the OLED panel to the Lumiblade OLED drivers at integration levels 2 and 4, and neither the lumen package nor failure detection require additional configuration.

Brite FL300 products (see figure 5.1) at integration level I are available with and without R_{set}/R_{win} . The FL300 L products (see figure 5.2) in level I are only available without R_{set}/R_{win} . Integration level I comprises two contact areas (FL300) and four contact areas (FL300L) on the back of the device for electrical connection:

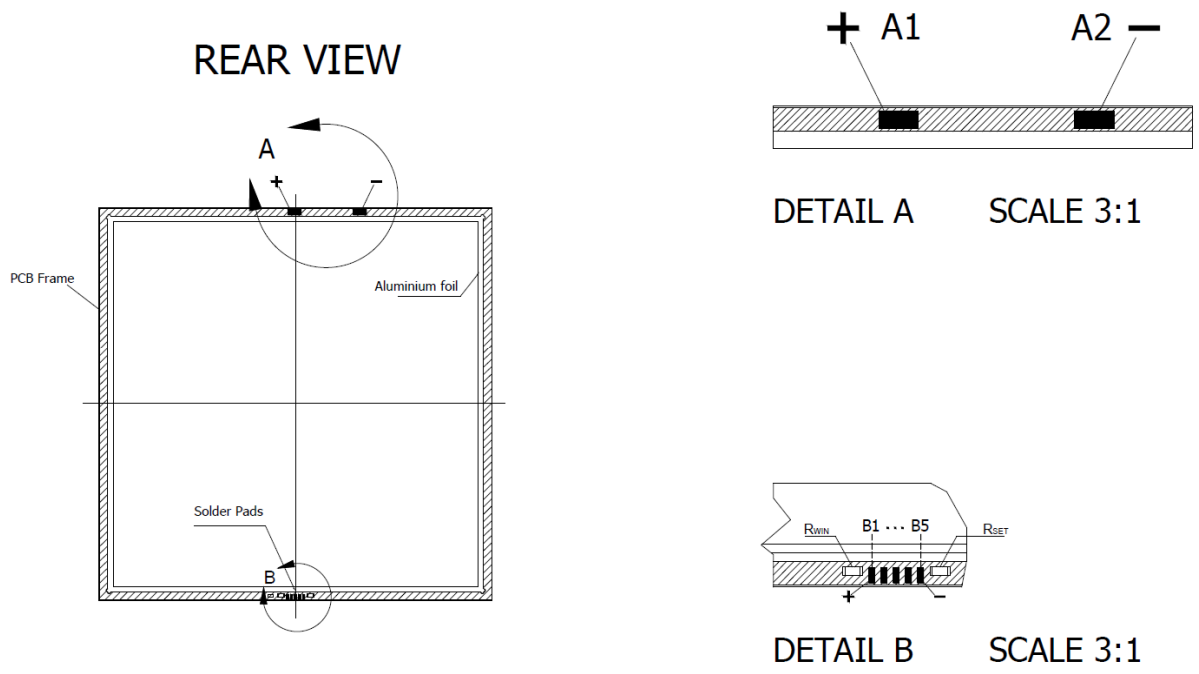

Figure 5.1 - channel connections from Brite FL300 integration level I to the driver

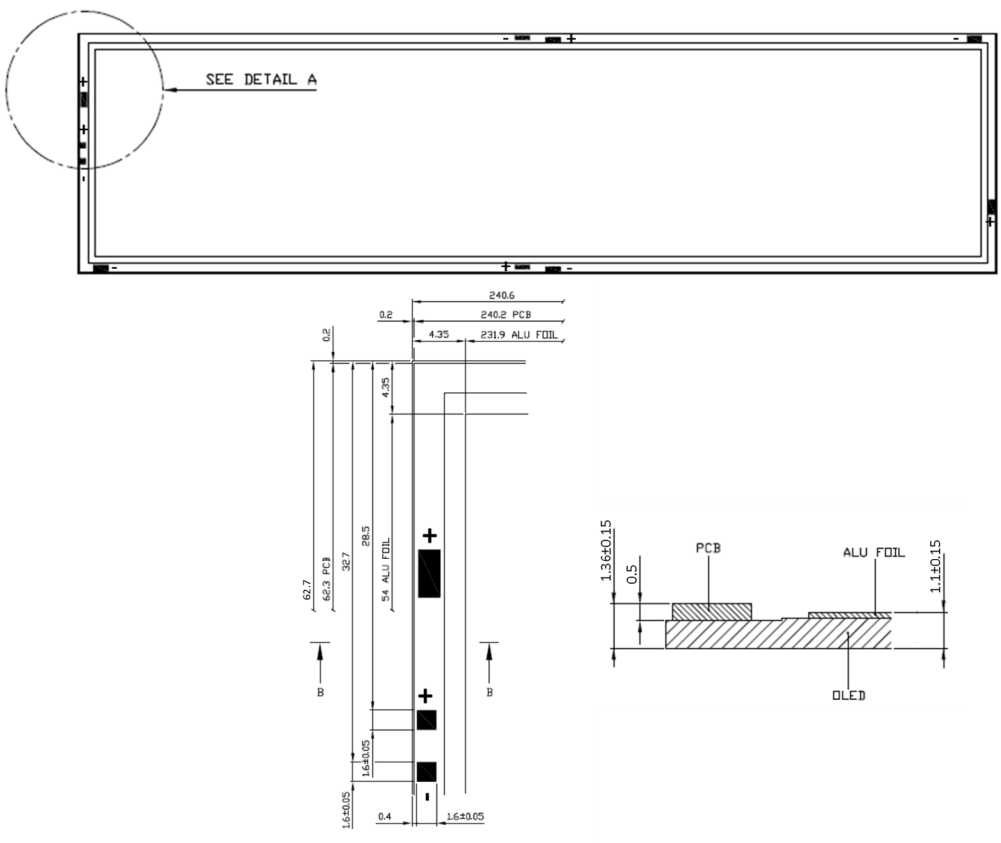

Figure 5.2: Brite FL300 L ww N w/o Rset – rear view, integration level I (top); Detail A (left) and cross section B-B (right)

If area A is used to electrically connect to the OLED panel, R_{set}/R_{win} cannot be transmitted and the driver has to be configured to match the device requirements. This also applies if only the outer solder pads in area B or the level I variant without R_{set}/R_{win} are used.

More information about how the resistors and the five solder pads in area B are interconnected is given in the product datasheet of FL300 including a diagram.

For more detailed information about R_{set} and R_{win} please refer to the datasheets on the Philips Lumiblade OLED drivers.

OLED current setting

If the Brite FL300 panel incorporates identification resistors as described above the output current and voltage driving window of the Lumiblade OLED driver automatically deliver the correct lumen package.

Should a different lumen package be required the following approaches are possible:

- Use integration level I without R_{set}/R_{win} (see Table I above for the Brite FL300 product family). In this case the driver output settings have to be programmed and the driver needs to be designed correctly to deliver the correct brightness level, lumen package and fault protection.
- Use driver features such as dimming to set the maximum brightness level. This is only appropriate for slight deviations from the encoded operating point.

If both these approaches do not suit your needs please contact Philips Lumiblade (contact details are provided at the end of this document).

Establishing electrical connections (soldering recommendations)

Wires should be soldered to the predefined plus and minus pole solder pads to establish an electrical connection (see Figure 5, area A). Alternatively, the 5-wire flat cable can be soldered to the defined 5-pole contact area (see Figure 5, area B).

We recommend soldering to establish an electrical contact. As high temperatures may damage the OLED panel, we recommend not exceeding the following parameters:

- maximum temperature of the soldering tip: 370 °C
- maximum soldering time in total (all 5 contacts): 5 seconds

Keeping the overall soldering time (duration of temperature impact) to a minimum can be achieved by using hot bar soldering equipment that simultaneously solders all 5 contacts (recommended). If individual wires need to be soldered the temperature of the OLED contact area should be left to cool down before this is done.

Cables

The length and type of cable needs to be considered in the design process of an application. Electrical loss due to the resistivity of the cables affects two aspects of the system (OLED <> driver):

- Wire resistivity leads to electrical loss and a voltage drop depending on wire lengths. When operating at a constant current the driver increases output voltage to reach the requested target driving current. Device performance is not instantly affected, however, the system will reach end of life more quickly as the upper voltage limit of the driver output window (R_{win}) is reached faster.
- An OLED fault leads to reduced voltage (see above). However, increased voltage level during normal operation also increases voltage in the case of OLED failure. Consequently, if the voltage is too high the driver may not detect the failure and therefore not turn the OLED off.

In both cases the maximum voltage drop due to the cables should not exceed 1 V.

Cables need to be selected in accordance with regulations and safety standards.

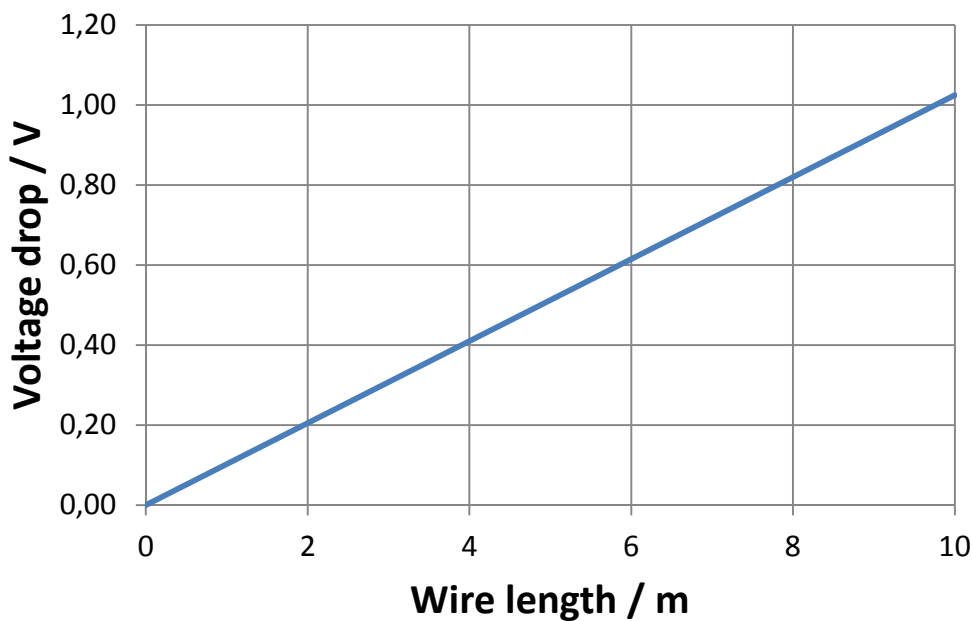

current : 0.368 A; material : copper (Cu); wire cross-section : 0.129 mm²

Figure 6 – theoretical estimation of drop voltage vs. wire length for a copper wire of 0.129 mm² cross-section and $I_{in rated} = 0.368$ A

The resistance (and consequently the voltage drop for a given current) of a cable can be theoretically estimated taking the wire cross-section, the material (specific resistance) and its length into account. An example is given above for a copper wire with a 0.129 mm² cross section. Please note that translating AWG values into wire cross-sections is not as dependable if stranded wires are used.

Be aware that it is the overall length of the wires and not the distance between driver and OLED that is relevant.

Assembly

Electrostatic discharge (ESD)

Introduction to ESD

Electro Static Discharge (ESD) can damage electronic components such as LED chips or OLED panels, resulting in early failures. Avoiding ESD damage to finished end products requires extensive measures when implementing electronic components. This is also valid for the implementation of OLED electronic components.

ESD in production environment

Reduction of ESD is required in the production environment, and ESD-vulnerable products should be packaged and delivered in ESD-safe packaging. The purpose of an effective ESD control strategy is the reduction of line failures, final inspection failures and field failures.

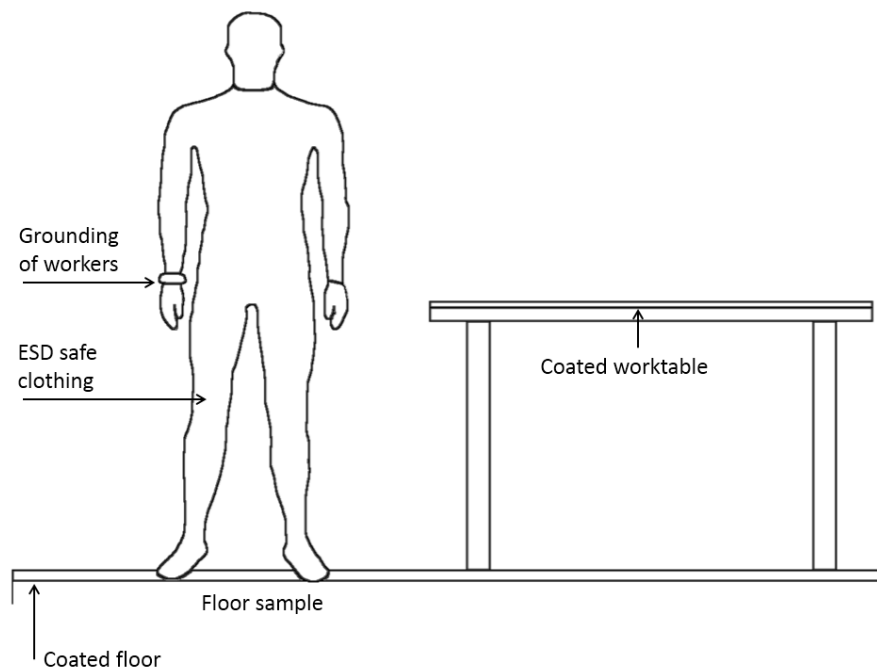

Figure 7 – Protection against ESD in manufacturing environments [source: Philips]

General recommendations in assembly

- Buildup of static friction between the product and surroundings should be minimized and all equipment (including floor, worktops etc.) should be electrically grounded.
- As shown in Figure 7, workers should be grounded and wear ESD-safe clothing
- Low levels of humidity also increase buildup of electrostatic and should be avoided. A level of 50% or more is recommended.
- Use of antistatic packaging for storage and transport is recommended.

For further information please contact Philips ESD support (see contact details at the end of this guide).

THERMAL INTEGRATION

OLEDs are solid-state lighting components. Like other electronic components the behavior of an OLED depends on its thermal state. The ambient temperature conditions as well as the driving conditions of the OLED itself influence the operating temperature.

Operating temperature has an impact on a several parameters including:

- driving voltage at a given current
- achievable lifetime (lumen maintenance)
- achievable reliability ⁵ (abrupt, catastrophic failures)

Local organic temperature differences in the OLED Panel may result in inhomogeneity. As the OLED itself also generates heat, depending on the driving current, the current directly impacts on the parameters given above.

Thermal requirements must be considered thoroughly in the design of the luminaire to achieve proper optical results and the targeted lifetime.

This chapter

- provides information on the general requirements for reliable operation
- gives indications on how to measure organic temperature
- lists typical aspects that may have an effect on device temperature and performance
- describes the differences between integration level I and integration levels 2/4

Integration aspects

General remarks

Description of the Brite FL300

Regardless of the integration level, the Brite FL300 comprises one major interface on the back which needs to be considered for thermal integration. At integration level I the back is made of thin aluminum foil (silver-like appearance) while at integration levels 2/4 the back is made of an anodized aluminum plate of 0.5 mm thickness.

The Brite FL300 integration level I comprises only very basic thermal functionality as it is designed to minimize OLED panel thickness for minimum element thickness and allow the highest degree of freedom in the design of luminaires. The metal foil only spreads the heat while heat dissipation needs to be accounted for in the luminaire design.

⁵ Reliability - the ability of the OLED panel to perform its required functions under stated conditions for a specified period of time.

Integration levels 2/4 feature a black metal back-plate for improved heat dissipation by radiation coupled with the metal foil by a heat pad for optimal thermal conductivity.

In the following the term 'thermal interface' relates to the metal foil (heat spreader) for integration level 1 and the metal back-plate for integration levels 2/4.

Reliable operation

Products have to be operated below a certain temperature level to achieve reliable operation throughout the targeted timeframe.

Apart from the likelihood of abrupt failures, (gradual) lumen maintenance is also temperature dependent. The Brite FL300 was designed for L70B50⁶ = 10,000 hours at an organic temperature of 50°C. This temperature is reached when the product is used at a rated current in vertical position at room temperature. Any other temperature results in lower or higher L70B50. The actual organic temperature is affected by power dissipation (driving current), thermal dissipation (thermal design) and ambient temperature.

Reducing temperature can significantly extend the expected lumen maintenance (for more information please see Figure 9, page 31).

The driving conditions, ambient conditions and the thermal design contribute to the actual organic temperature of the panel, which determines lifetime. This can generally be controlled by:

- control of ambient temperature (of the luminaire, consequently also of the OLED)
- active cooling (within the luminaire)
- reduction of driving current (affects light generation)

Each of these approaches has a drawback:

- ambient temperature control options limited to customer requirements may interfere with the recommended OLED panel temperature.
- active cooling options may add to the thickness of the luminaire design, limiting freedom of design.
- current control affects the amount of light generated and the brightness of the product. While this may be undesirable for some applications it may be a desired for others.

A thorough assessment of customer needs and application requirements and choosing from a combination of the measures mentioned above best suited to the design is therefore recommended.

Reduction of current may be the only way to reduce temperature for a given environment and design.

⁶ L70B50 describes the point in time when 50 % of the remaining population yields at least 70% of the initial luminous flux.

How to measure organic temperature

The organic temperature is the temperature of the organic layers which determine the lifetime of the product. The temperature at the center of the device should be approximately the same as the temperature on the glass at the front.

When the term 'organic temperature' is mentioned in this document it always refers to the temperature at the center of the light emitting area on the front measured with a thermo-couple, for example 5TC-TT-KI-36-2M type K (nickel-chrome/nickel) directly attached to the surface (Figure 8, position B, left).

Note: To improve accuracy of measurement a small amount of thermal paste may be used. Be aware that the paste may leave stains on the product.

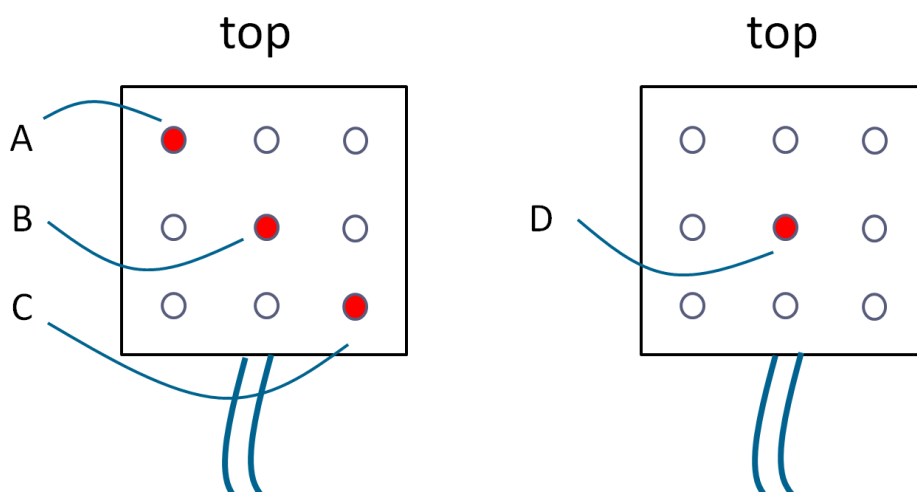

Figure 8 - measurement positions used throughout this guide (left: front view, right: back view)

Please note that mounting the OLED panels in a vertical position when measuring the organic temperature may lead to convection and thus alter the results. This is especially true for integration level I.

If a climate chamber has to be used to simulate certain ambient conditions be aware that integrated ventilation may alter the results due to forced convection.

A thermo-couple in the vicinity of the device but shielded from temperature created by the device itself should be used to make ambient temperature readings.

Impact factors

Current

The relationship between luminous flux and driving current is almost linear. Increase of driving current also increases temperature (increased power consumption)

Organic temperature

Organic temperature determines lumen maintenance and reliability. Elevated temperatures accelerate the aging of the device which primarily results in lower lumen output and voltage increase. Voltage increase at constant current driving also leads to increased power consumption and increased temperature.

Expected lifetime (lumen maintenance)

Figure 9 shows the approximate expected lumen maintenance L70B50 for different points of operation: luminous flux (equivalent to current) and organic temperature. This gives an indication of how an increase in organic temperature at a given current affects lifetime and vice versa.

Current reduction has two effects: It directly increases the lifetime of the OLED due to reduced electrical stress and indirectly extends the lifetime by decreasing the organic temperature.

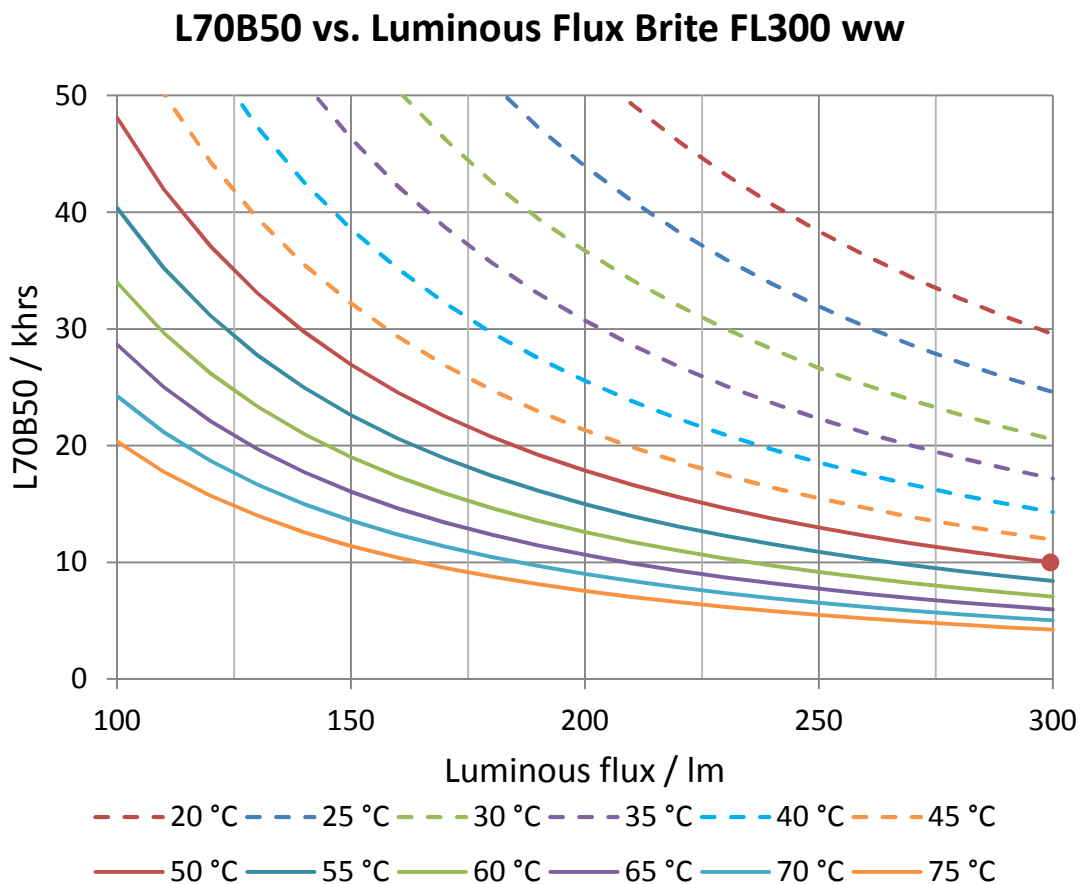

Figure 9 – L70B50 vs. luminous flux and organic temperature

Example:

Question: Is it possible to achieve an L70B50 of 50,000 hours if the current is reduced from 0.368 A to 0.135 A?

Answer: An ambient temperature of 25 °C with a driving current of 0.368 A (approx. 300 lm) and a resulting organic temperature of approx. 51 °C would result in an expected lumen maintenance of L70B50 = 10,000 hours for a Brite FL300 ww. By reducing the current to 0.135 A (approx. 115 lm) the expected lumen maintenance would be extended to L70B50 = 45,000 hours. This alone seems insufficient for achieving L70B50 = 50,000 hours. However, as the power consumed and therefore the heat generated by the panel is also reduced, the organic temperature decreases to about 35 °C. Selecting the appropriate curve for 35 °C organic temperature (light blue) results in an L70B50 beyond 50,000 hours. So the answer to the question is 'yes'.

Figure 10 (below) shows the dependency between organic temperature and ambient temperature at different currents. This is only an orientation; air movement, mounting options etc. have a significant impact on resulting organic temperature. The graph shows mean values of temperature measurements taken from Brite FL300 ww N panels, vertically mounted and measured at spot B on the front. The device had warmed up to steady state before the temperature measurement was made.

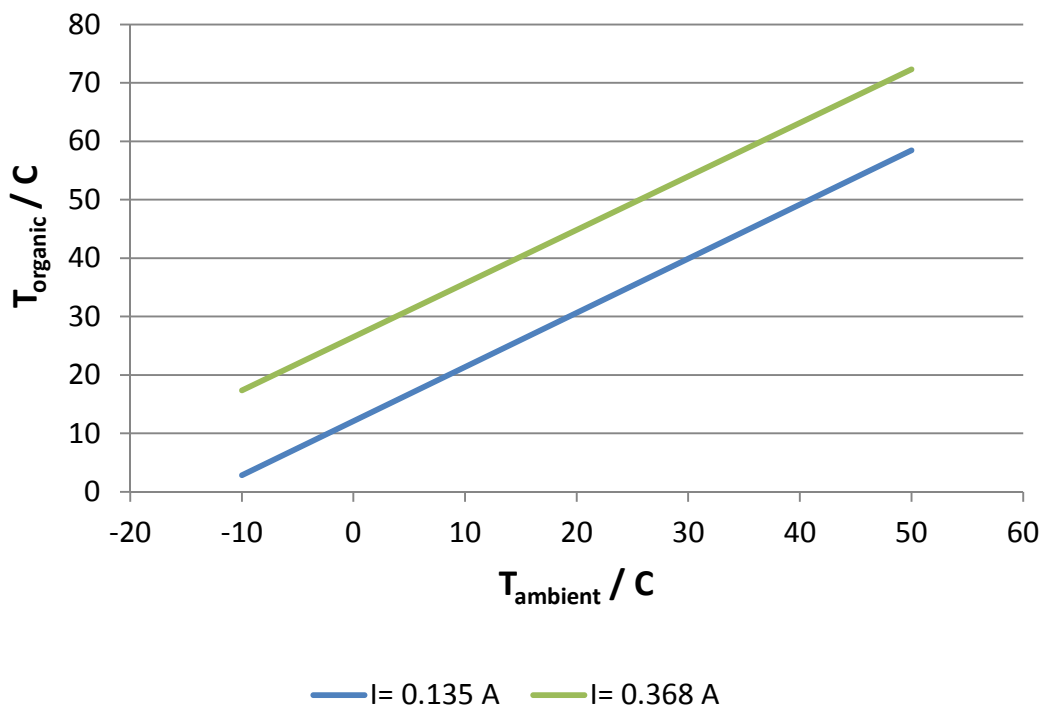

Figure 10 – Indicative relationship between T_{organic} and T_{ambient} at different driving currents ($I = 0.135 \text{ A}$, 0.368 A) for integration level I, mounted vertically in air. Actual relationship strongly depends on thermal interface.

Device aging

During the lifetime of the OLED panel the voltage increases. As a consequence the power consumed and heat generated by the OLED panel increases in constant current driving mode.

Ensure that sufficient thermal management is designed into the luminaire to keep the device at required temperature levels, particularly when approaching the end of lifetime. Detailed data on voltage at end of life are given in the relevant datasheets.

As a rule of thumb an increase of ~ 4 °C in temperature for each additional Watt consumed by the OLED Panel Brite FL300 at integration level I mounted vertically and exposed directly to air can be expected. Integration levels 2/4 increase slightly less in similar mounting conditions.

Device orientation on temperature and homogeneity

Brite FL300 integration level I primarily dissipates heat by convection. As device orientation has an impact on convection it also influences the organic temperature distribution and therefore the homogeneity of light emission.

Brite FL300 integration levels 2/4 comprise a metal back-plate which improves heat dissipation by radiation. Although some heat dissipation by convection still occurs, the impact of device orientation exposed directly to air on the homogeneity of temperature and light emission is reduced.

In general, all measures to improve heat dissipation by other means than convection (e.g. radiation and conduction) decrease the impact of device orientation on homogeneity and are therefore recommended in the luminaire design.

Mounting components

The Brite FL300 main thermal interface is on the back. The main differences between integration level I and level 2/4 are given above. While level I simply spreads heat and requires additional measures to remove thermal energy, integration levels 2/4 provide a black back-plate thermally coupled to the metal foil (heat spreader) which improves heat dissipation by radiation.

This section briefly describes the impact that selected mounting components applied to the thermal interface of the Brite FL300 may have. The data given are exemplary and to be considered as indicative. To ensure reliable operation the luminaire design itself needs to be assessed with respect to the resulting organic temperature at targeted currents and ambient conditions. See above on how to measure organic temperature.

Comparison of different exemplary counterparts

As a general rule, if the mounting component is to function as a heat sink, optimizing the thermal contact between the thermal interface of the Brite FL300 and the mounting unit is desirable. In this case mounting towards an element will generally improve performance as it cools the OLEDs or at least keeps it within a certain temperature range. Cooling efficiency is dependent on the quality of the thermal coupling between the panel and the mounting unit. Dedicated heat pads are recommended although from a purely thermal perspective thermal pastes could also be used. Before using pastes please refer to the section on mechanical integration (see page 12).

If mounting components are to function as thermal insulators, other design approaches may need to be considered to keep the OLED working reliably.

Typical temperatures for some exemplary mounting materials

This section provides some indicative measurements for an OLED panel mounted on different materials. Measurements have been executed at room temperature ($T_{\text{ambient}} = RT \sim 25$ °C); the organic temperatures

are shown below in Figures 11 and 12. Wood and aluminum plates have been chosen as typical mounting material that may be used in luminaire design⁷. Data is given for three different driving modes reflecting lumen output of approximately 100, 200 and 300 lm. Measurement accuracy is about ± 1 °C.

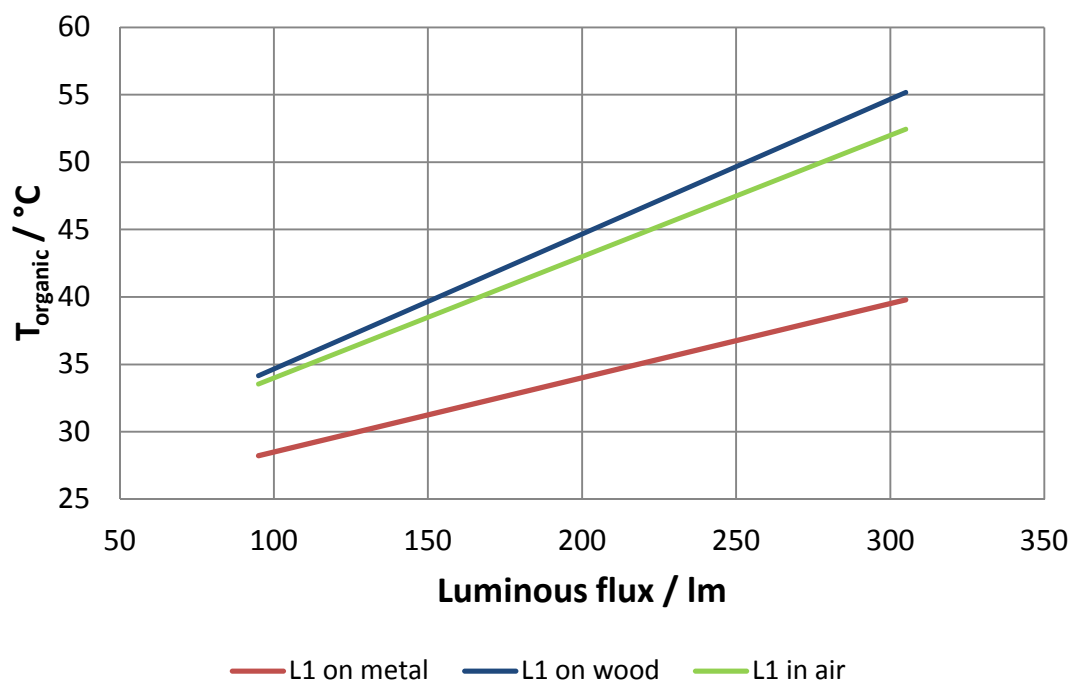

Figure 11 - indicative organic temperature vs. flux for different mounting materials – integration level 1

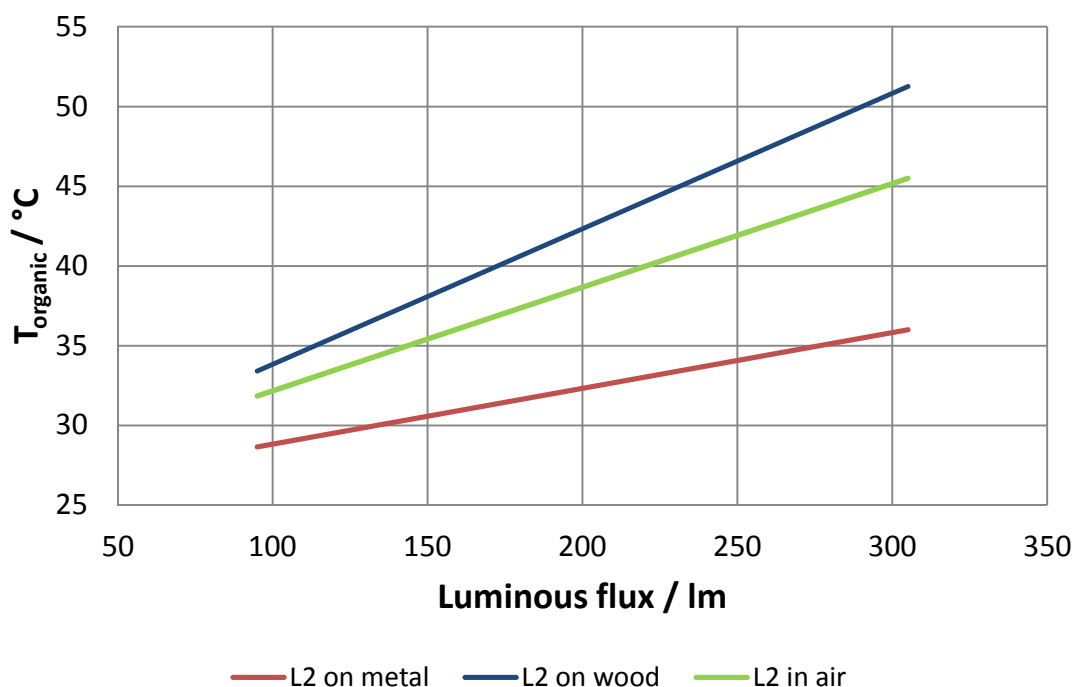

Figure 12 - indicative organic temperature vs. flux for different mounting materials – integration level 2

⁷ wood : thickness = 16 mm, type = plywood, lateral dimensions = 40 x 40 cm²; white aluminum metal : thickness = 1.5 mm, lateral dimensions = 40 x 40 cm²

Figure 11 and Figure 12 show examples for integration levels 1 and 2. Integration level 4 yields similar results to level 2:

- For integration levels 2/4, wood insulates heat dissipation by radiation through the metal back-plate resulting in higher temperatures than when directly exposed to air. This tendency is of varying importance depending on driving conditions (e.g. amount of generated heat).
- Higher integration levels lead to lower temperatures under almost all conditions (mounting units and driving points). Integration levels 2 and 4 are identical.
- For all integration levels mounting on a metal unit is always best as it conducts heat efficiently resulting in the lowest possible temperatures.

Please note that the choice of mounting material and the resulting temperatures have a significant impact on lifetime. Figure 9 shows the impact using FL300 ww.

Notes on thermally active mounting element

So far the examples given have based on passive mounting units. However, if an active element were mounted directly onto the thermal interface area of the Brite FL300, the temperature generated by this component would also need to be considered. An active component, for example a driver, not only limits heat dissipation but also adds thermal energy.

Due to the additional temperature direct contact between thermally active components and an OLED panel is not advisable. Alternatively, organic temperature needs to be reduced by other means (see above).

Also note that Brite FL300 panels mounted back-to-back also constitute active components adding to overall heat.

Impact of temperature on electrical properties

The electrical properties of OLEDs change with temperature.

This section describes the general impact of ambient temperature on OLED voltage for a given current. For accurate data on the specific OLED panel in use please refer to the product datasheet.

OLED resistivity is reduced with increasing organic temperature. This has two consequences on the voltage in constant current driving mode.

- First, at a given ambient temperature the voltage required to start up the OLED is higher than in a steady state. The voltage drops after turning on the device due to the heat caused by operation. When driving the Brite FL300 ww N at a rated current and room temperature the drop in voltage is typically around 1.3 V after the first 10 minutes of operation.
- Second, and in addition to this, the ambient temperature has the same impact on the OLED driving voltage but also leads to differences in the steady state after being turned on.

Figure 13 shows this dependency. While variation in ambient temperature leads to a shift in the overall voltage curve, this decreases towards a steady state within the first 5 minutes following the device being turned on.

Please note that with lower temperatures the difference in voltage from being turned on to achieving a steady state increases. If turning on at low temperatures is required this needs to be considered in the choice of the driver.

This voltage increase adds to the overall voltage increase as the panel ages and may prevent a driver starting up an OLED even though there would be enough power in a steady state.

When Lumiblade OLED drivers are used together with Brite FL300 panels proper operation within defined usage is ensured.

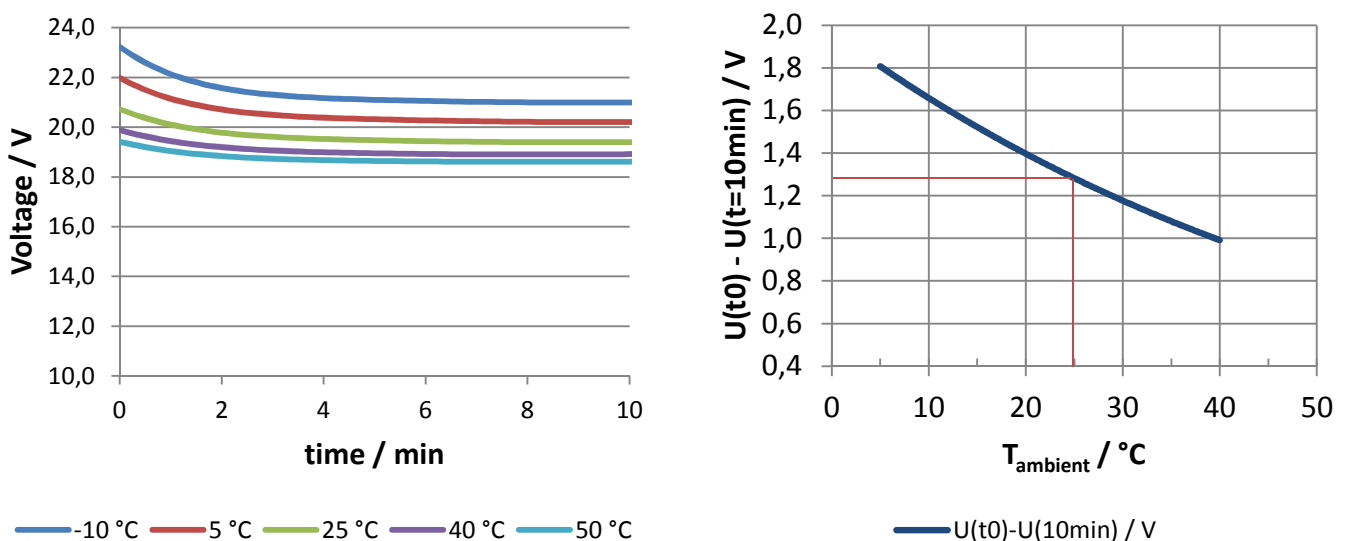

Figure 13 – (left) dependency of driving voltage at constant current ($I = 0.368$ A) on ambient Temperature $T_{ambient}$; (right) voltage drop after turn on at $T_{ambient} = RT (= 25$ °C)

Optical performance changes (color points and luminous flux) during the warm-up phase are negligible.

Additional information

Tc

In contrast to driver electronics there is no Tc mark on the Brite FL300 as the entire panel has to fulfill the temperature requirements (see datasheet). Inhomogeneity may cause problems (see above). Temperatures should be measured at point B of the panel (see Figure 8).

Moisture / humidity

Be aware that relative humidity may increase if temperature changes to lower values. Recommended usage of the Brite FL300 does not account for dew, moisture, water in direct contact with the device as this alters the extent of lifetime (see datasheet for use cases). If the application is exposed to rapidly changing temperatures and high relative humidity levels please take appropriate precautions.

Contact details

Philips Lumiblade OLED Panel Brite FL300 and Lumiblade Drivers

OLEDWorks GmbH
Philipsstr. 8, 52068 Aachen, Germany
info@lumiblade-experience.com

For more information visit:

www.lumiblade-experience.com
www.facebook.com/lumiblade
www.twitter.com/lumiblade
www.youtube.com/user/PhilipsLumiblade

Philips ESD support

The Philips Innovation Services EMC center is a leading provider of approbation and consultancy services.

phone: +31 (0) 40 27 48883
innovationservices@philips.com

For more information visit:

www.innovationservices.philips.com



© 2014 Koninklijke Philips N.V.
All rights reserved. Correct at 08/2014

LOGISTICS DATA

Philips Lumiblade OLED Panel Brite FL300 ww family

These products are tuned for maximum performance and functional lighting applications.

Specification item	Value
Product name	Philips Lumiblade OLED Panel Brite FL300 ww N
Order code	872790037979240
Logistics code I2nc	9254.000.09401
EAN3	8727900379808
Pieces per box	20

Specification item	Value
Product name	Philips Lumiblade OLED Panel Brite FL300 ww A0
Order code	872790037981531
Logistics code I2nc	9254.000.09501
EAN3	8727900379822
Pieces per box	6

Specification item	Value
Product name	Philips Lumiblade OLED Panel Brite FL300 ww BI PCAL
Order code	872790037983931
Logistics code I2nc	9254.000.09601
EAN3	8727900379846
Pieces per box	6

Specification item	Value
Product name	Philips Lumiblade OLED Panel Brite FL300 ww N w/o Rset
Order code	872790037992140
Logistics code I2nc	9254.000.11401
EAN3	8727900379938
Pieces per box	20

Specification item	Value
Product name	Philips Lumiblade OLED Panel Brite FL300 L ww N w/o Rset
Order code	871869653242300
Logistics code I2nc	925400013201
EAN3	8718696532430
Pieces per box	20

Specification item	Value
Product name	Philips Lumiblade OLED Panel Brite FL300 L ww A0
Order code	871869653244700
Logistics code I2nc	925400013301
EAN3	8718696532454
Pieces per box	10

Philips Lumiblade OLED Panel Brite FL300 wm family

These products are designed with a special mirror finish when not in use. The performance of these devices is slightly lower than those of the Brite FL300 ww family.

Specification item	Value
Product name	Philips Lumiblade OLED Panel Brite FL300 wm N
Order code	872790037985340
Logistics code I2nc	925400012501
EAN3	8727900379877
Pieces per box	20

Specification item	Value
Product name	Philips Lumiblade OLED Panel Brite FL300 wm A0
Order code	872790037988431
Logistics code I2nc	925400012601
EAN3	8727900379891
Pieces per box	6

Specification item	Value
Product name	Philips Lumiblade OLED Panel Brite FL300 wm BI PCAL
Order code	872790037990731
Logistics code I2nc	925400012701
EAN3	8727900379914
Pieces per box	6

Specification item	Value
Product name	Philips Lumiblade OLED Panel Brite FL300 L wm N w/o Rset
Order code	871869653238600
Logistics code I2nc	925400012901
EAN3	8718696532393
Pieces per box	20

Specification item	Value
Product name	Philips Lumiblade OLED Panel Brite FL300 L wm A0
Order code	871869653244700
Logistics code I2nc	925400013001
EAN3	8718696532416
Pieces per box	10

Philips Lumiblade OLED Drivers

Mains driver, 8 output channels, TouchDim/DALI and analog control

Specification item	Value
Product name	Driver D230V 80W/0.1-0.5/1A/28V TD/A 8CH
Order code	872790037921130
Logistics code 12nc	925400010201
EAN3	8727900379228
Pieces per box	10

Specification item	Value
Product name	Driver D230V 80W/0.1-0.5/1A/28V TD/A 8CH
Order code	50046677256598
Logistics code 12nc	925400010202
EAN3	50046677256598
Pieces per box	1

Single channel low voltage drivers

Specification item	Value
Product name	Driver D024V 10W/0.1A-0.4A/28V D/A
Order code	872790037919840
Logistics code 12nc	925400010101
EAN3	8727900379204
Pieces per box	20

Specification item	Value
Product name	Driver D024V 10W/0.1A-0.4A/28V D/A
Order code	872790037919866
Logistics code 12nc	925400010102
EAN3	8727900379488
Pieces per box	1

Specification item	Value
Product name	Driver D024V 10W/0.1A-0.4A/28V DMX
Order code	872790037977866
Logistics code 12nc	925400012001
EAN3	8727900379785
Pieces per box	1

Specification item	Value
Product name	Driver D024V 10W/0.1A-0.4A/28V DMX
Order code	872790037977836
Logistics code 12nc	925400012002
EAN3	8727900379860
Pieces per box	16