

PHILIPS



Fortimo

LED system

SLM Gen4/Gen4+

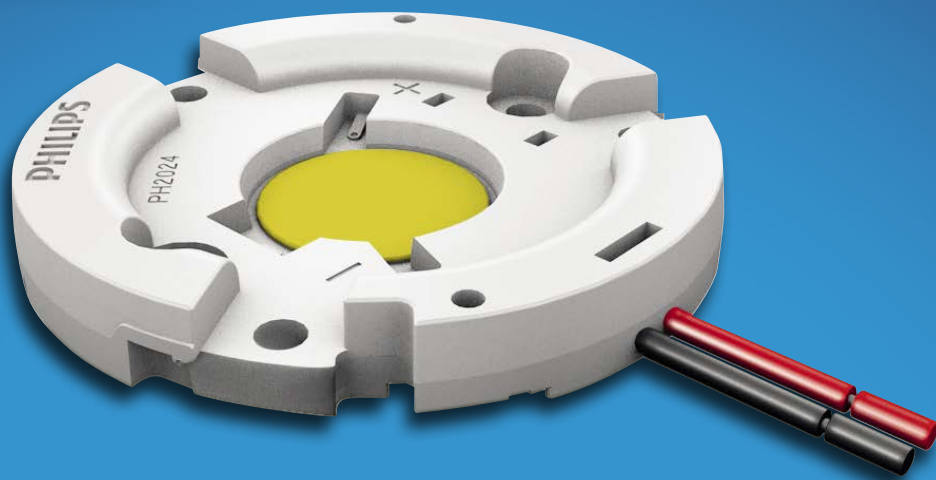

Design-in Guide

New levels of **brightness**
and **saturation** in retail

February 2015

Contents

Introduction to this guide	4	Active and passive cooling	18
Information and support	4	Complementary thermal solution partners	19
Determine which documents contain what information	4	Electrical design-in and flexibility	20
Warnings and instructions	5	Connection to the mains supply	20
When using a driver, intended for these modules	5	Double Isolated Drivers	20
Safety warnings and installation instructions	5	Tune the luminaire's flux (lm) and efficacy (lm/W)	20
Design-in phase	5	Effect of Choosing a different current value	20
Manufacturing phase	5	Set the output current via Rset	21
Installation and service for luminaires incorporating the Fortimo LED SLM System	5	To Find the correct Rset for the required current	22
Philips Design-in support	5	How to... Program the output current	24
Introduction the SLM Gen4/Gen4+ system	6	Xitanium Indoor Spot and Downlight LED drivers	24
Application Information	6	Xitanium Driver Operating window	25
Module types	6	To Select an Appropriate Driver	26
Choosing the Correct Fortimo LED SLM module	7	Compatible Drivers with SLM Gen4/Gen4+	26
Naming of the Fortimo LED spotlight modules	7	Reliability	28
Assembling your Fortimo LED SLM module	7	Lumen maintenance	28
Can the module be used in outdoor luminaires?	8	Controllability	29
In this design-in guide	8	Dimming the Philips Fortimo LED SLM system	29
Holders for Fortimo SLM Gen4/Gen4+	9	Philips lighting control systems	29
Xitanium LED drivers for Fortimo LED SLM Gen4/Gen4+	10	Complementary partners	30
Zhaga*	10	Compliance and approval	31
Optical design-in	11	Compliance and approbation	31
Light distribution	11	IP rating, humidity and condensation	31
Reflector design limits	11	Electrostatic discharge (ESD)	31
Ray sets	11	Some facts on blue light	32
Color consistency	12	Environmental compliance	32
Color targets	12	CrispWhite Technology	32
Spectral light distribution	12	Chemical Compatibility	33
Complementary reflector partners	12	Safety	34
Starting characteristics	12	Philips Xitanium driver	34
Mechanical design-in	13	Electromagnetic compatibility	34
Fortimo LED SLM Gen4/Gen4+ module dimensions	13	Environmental	34
Recommended torque	13	Cautions	34
Wires for SLM Gen4/Gen4+	13	Contact details	35
Poke-in versions	13	Philips	35
Thermal design-in	14	Philips ESD support	35
Optimum performance	14	Disclaimer	36
Test requirements	14		
Critical measurement points	14		
Tc-nominal and Tc-max	15		
How to measure the critical temperature point Tc	16		
Thermal interface material	16		
Electrical and thermal analogy	17		
Thermal model	17		
Thermal design of a heat sink	17		

Introduction to this guide



Fortimo LED SLM Gen4/Gen4+ module

Thank you for choosing the Philips Fortimo LED SLM Gen4/Gen4+. In this guide you will find the information required to design this module into a luminaire.

Information and support

If you require any further information or support please consult your local Philips office or visit our website: www.Philips.com/Technology

Determine which documents contain what information

In order to provide information in the best possible way, Philips' philosophy on product documentation is the following.

- **Commercial leaflet** contains product family information & system combinations (compatible Philips drivers and Rsets)
- **Datasheet** contains the module (CoB and holder) specification
- **Design-In Guide** describes how to design-in the products

All these documents can be found on the download page of the OEM website www.Philips.com/Technology.

If you require any further information or support please consult your local Philips office.

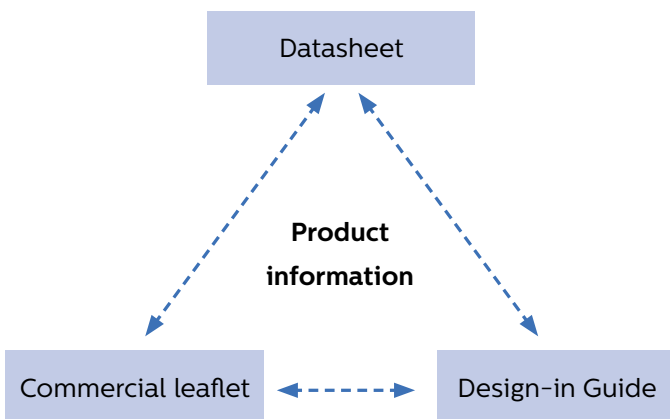

Warnings and instructions

When using a driver, intended for these modules



Warning:

- The Philips Fortimo LED SLM Gen4/Gen4+ modules must be operated with double isolated (SELV) drivers!
- Avoid touching the light emitting surface!

Safety warnings and installation instructions

To be taken into account during design-in and manufacturing.

Design-in phase

- Do not apply mains power to the module (Philips Fortimo LED SLM Gen4/Gen4+ CoB and holder) directly.
- Connect the modules and drivers before switching on mains.
- Provide adequate environmental protection
- Due to the increased Tcase nominal temperature of the Fortimo LED SLM Gen4/Gen4+ to 85 °C, it is important to take into account the maximum touchable metal surface temperatures of the luminaire. With such a high Tc temperature the maximum temperature for touch safety can easily be exceeded.
- Avoid contamination (direct or indirect) from any incompatible chemicals reacting with the silicone. A list of incompatible chemicals is provided in the chapter for Compliance and Approval.

Manufacturing phase

- Do not use products in case the phosphor on the CoB is discolored/ scratched or if the holder is broken.
- Do not drop the LED SLM or damage in any way.
- Connect the modules and drivers before switching on mains.
- Avoid contamination (direct or indirect) from any incompatible chemicals reacting with the silicone. A list of incompatible chemicals is provided in the chapter for Compliance and Approval.

Installation and service for luminaires incorporating the Fortimo LED SLM System

- Do not service the luminaire when the mains voltage is connected; this includes connecting or disconnecting the LED SLM holder from the driver.

Philips Design-in support

Is available; please contact your Philips sales representative.

Introduction the SLM Gen4/Gen4+ system



Standard version



Poke-in version



*Measurements showing compliancy to Zhaga book 3 version 1.2 have been done on the 3000 lm L15 module with the standard holder.

Application Information

The Philips Fortimo LED Spotlight Module (SLM) is a high-performance, compact, and cost-effective series of products for general and accent lighting. This product offers a long-lifetime and energy efficient lighting solution for retail, hospitality and general down-lighting applications. It is consistent with other Fortimo families of modules, delivering a high quality of light and peace of mind.

Module types

The SLM Gen4/Gen4+ module comprises of a range of CoBs that can be paired with the following holders:

- A standard holder with fitted pre tinned cables (with or without a sleeve)
- A poke-in holder

An overview is provided in the Commercial Leaflet in the download section on www.Philips.com/Technology.

The user can choose different resistor values (to be used in the driver) in order to operate any of these modules at different currents to obtain a required lumen output.

The Fortimo LED SLM Gen4/Gen4+ module comes in 4 categories (standard version, special versions, downlight versions and premium white version) with different options, each option providing the user with the flexibility to use the CoB at various operating points in order to achieve a high lm/W or a high lm/€. Each product can also be bought in combination with the poke-in holder. This provides the user with a full portfolio comprising of a wide range of products.



Warning:

On ordering a Fortimo SLM module, the customer will receive a box stating the lumen output and colour of the requested CoB. Please note that once opened, it is difficult for the user to differentiate between CoBs of different colours. Care must be taken to ensure that such a situation does not occur.

In this guide you will find the specific information required to develop a luminaire based on Philips Fortimo LED SLM module. Product specific data can be found in the associated datasheet on www.Philips.com/Technology.



Fortimo LED SLM Gen4/Gen4+ module

Choosing the Correct Fortimo LED SLM module

The Fortimo SLM module is offered in a wide range of options. Please refer to the appropriate datasheets for details about each module. It is possible to choose any of the modules based on the standard settings, along with the appropriate driver and recommended Rset. This module can then be used at a number of different operating points to suit your needs.

Naming of the Fortimo LED spotlight modules

The names of the modules are defined as shown in the example below:

Fortimo LED SLM 3000 lm 830 XX L15 G4+

- Fortimo : Our brand name for high-quality, efficient, smart, future-proof and reliable LED lighting
- LED : The source used
- SLM : Spotlight module
- 3000 lm : 3000 lumen, typical light output (changes depending on mode)
- 830 : For a color rendering index >80; 30 stands for a CCT of 3000 K

XX This stands for the following names:

- CW = CrispWhite (special versions category)
 - FW = Food Warm White (special versions category)
 - FR = Food Premium Red (special versions category)
 - DL = Down-light Version (downlight versions category)
 - PW = Premium White
 - PI = Poke-in
- L15 = LES (Light Emitting Surface) has a diameter of 15 mm
 - G4 = Indicates the generation Gen4
 - G4+ = Indicates the generation Gen4+

Assembling your Fortimo LED SLM module

The Fortimo SLM module is delivered to you as a combination of the CoB and holder. To assemble the two, please ensure that the + and – sign on the CoB are aligned with that on the holder. The CoB must be clicked into the slot by pushing back onto the spring. The pictures on the left explain this process step by step.

Note: For the poke-in (PI) holder for L19, a provision is made to incorporate CoBs of various thickness. Two stainless steel clamps are integrated within the holder and are activated by screwing down into the heat sink. Depending on the type of CoB, there may be no contact with the heat sink once inserted into the holder. When clamps are screwed down, the CoB will have a good thermal down force. It is a metal, mechanically closed system so there will be no plastic creepage.

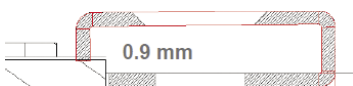
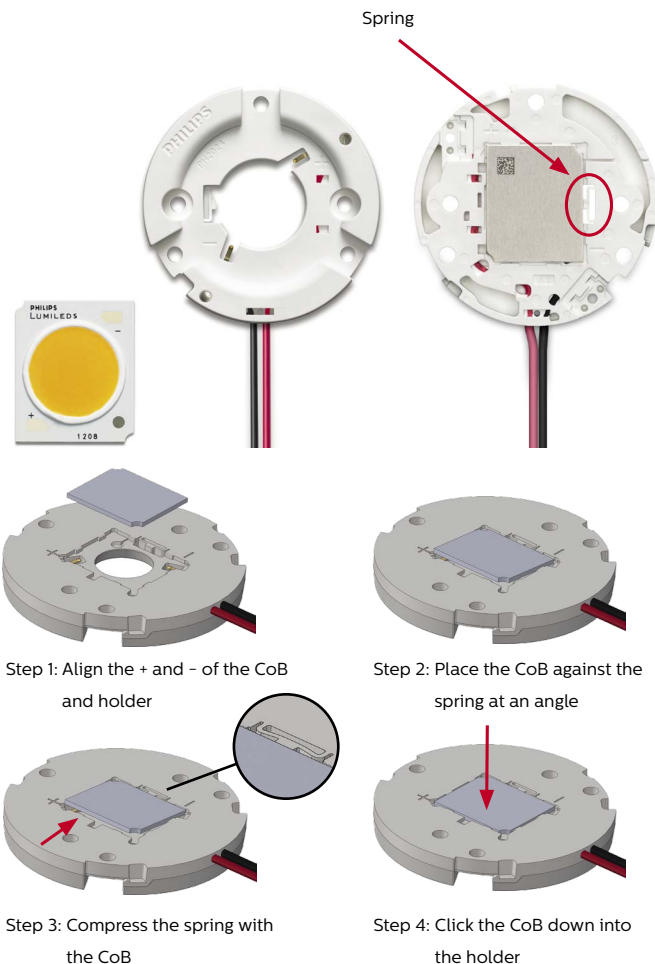

Can the module be used in outdoor luminaires?

Neither the Fortimo LED module nor the LED driver has an IP classification. If these products are used in luminaires for outdoor applications, it is up to the OEM to ensure proper protection of the luminaire. Please consult us if you wish to deviate from the design rules described in this guide.

In this design-in guide

In this design-in guide you will find all necessary guidelines to configure the Fortimo LED SLM module to exactly fit your needs.

The range consists of Chip-on-Board (CoB) and holders: standard (with fitted pre tinned cables, with or without a sleeve) and poke-in version, that can be divided into four general categories:

- Standard versions in various lumen packages and colours
- The SLM Premium White for a different colour point as the standard versions
- Special versions which consist of the following types:
 - SLM CrispWhite: For intense whites and rich colours.
 - SLM Food Warm White: A specific spectrum for enhancing the appearance of fresh food.
 - SLM Food Premium Red: A specific spectrum for enhancing the appearance of fresh meat.The initial purpose of this product is for retail lighting applications, more specifically for e.g. food, furniture and leather. The product is not intended for use in other applications.
- Downlight versions which come with tin dipped sleeved cables to be used in independent applications (or spotlight applications with independent drivers). These are also available for some SLM Premium White modules and special versions. Please check the appropriate datasheets at www.Philips.com/Technology for more information.

The pre-tinned cables come in a length of 60 cm. The OEM can cut this to the length required. However, in the case of downlight versions where the cables are in a sleeve, this is not advised.

Note:

It is advised to avoid sharp corners in your luminaire where the wires need to pass. This is done to avoid damage to the insulation of wires.

On top of this broad range in standard settings and building blocks, the Fortimo LED SLM portfolio provides the luminaire manufacturer with a high level of flexibility to obtain a specific luminaire performance, while using the same components. In combination with our Xitanium LED drivers, the user has the possibility to drive their module at different currents in order to achieve a high lm/W or a high lm/€ at different lumen outputs.

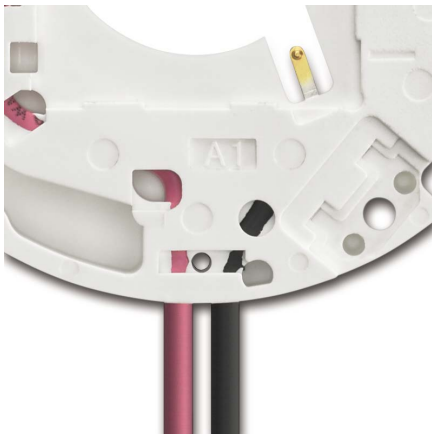

Holder with version code A1



Holder with version code C2

Holders for Fortimo SLM Gen4/Gen4+

The Fortimo SLM Gen4/Gen4+ system can be supplied with a selection of CoBs and holders. In this section, we describe the differences in the holder types:

1. Holder with Pre-tinned Cables (60 cm)

Each Cob can be bought in combination with this holder. The length of the cable is by default 60cm, but the customer can cut it to the appropriate length if needed.

2 Holder with Tin-dipped Cables, with a sleeve (60 cm)

These holders are available if the Fortimo SLM module must be used in a downlight application. Any of the modules listed as downlight versions are available with this holder. It is not advised to cut the length of this cable.

The above 2 holder types have had a series of generation updates. This can be seen by observing the Alpha-numerical code on the back of the holder as shown in the picture on the left. The generation sequence starts at A1 and continues forward. These changes rarely make a difference for the customer, and if it does it is for the positive. For example, from version C2, daisy chaining of SLM Gen4/Gen4+ modules is allowed (not allowed with poke-in holders). Please contact your Philips representative for details, especially when working with high voltages to ensure safe operation.

3. Poke-in holder

All modules with a PI (poke-in) in the naming are available with this holder. The absence of cables on the holder, allows for late stage configuration. Please note that this holder has a different height than the other two versions. Details of the dimensions are provided in the datasheets available at www.Philips.com/Technology. A number of features can vary between this type and the others. It is important to read this guide in order to understand this. The table on the left shows a summary of differences.

Standard/downlight version	Poke-in version
Fitted with pre tinned cables (with/without a sleeve)	No cables attached
CoB clicked in by pushing against the spring	CoB clicked in by pushing against the spring for the holders catering to LES 9 – 15. The holder for LES 19 has a different mechanism. Two metal springs are provided. The holder can be pressed against the CoB to click it in.
ENEC certification in process	Not ENEC certified
Zhaga compatible	Not Zhaga compatible except for the position of the screw holes.
Higher	Lower (dimensions available in datasheets)
3 screw holes available, along with 2 Zhaga compatible screw holes	Only the Zhaga screwholes are available
Daisy chaining allowed after version C2	Daisy chaining not allowed
Provision to feed through a thermo couple wire to use the T sense point	No such provision
Late stage configuration not possible	Late stage configuration possible
Provision for easy reflector attachment	No provision for reflector attachment



Fortimo LED SLM Gen4/Gen4+ module



*Measurements showing compliancy to Zhaga book 3 version 1.2 have been done on the 3000 lm L15 module with the standard holder.

Xitanium LED drivers for Fortimo LED SLM Gen4/Gen4+

These highly efficient LED drivers are designed for the Fortimo LED modules. These are available as a built-in or independent driver, dimmable or with a fixed output.

More information about the Xitanium drivers for Fortimo LED SLM Gen4/Gen4+ modules can be found in the Xitanium indoor down and spotlight driver design in guide and the Xitanium commercial leaflet. These documents can be downloaded via www.Philips.com/Technology.

The Xitanium driver datasheets can also be downloaded on this website.

Zhaga*

Zhaga is a global consortium from across the lighting industry. The overriding aim is to bring standardization to applications in general lighting by creating well defined interface specifications.

This ensures the interchangeability of LED light sources from different manufacturers. The Fortimo LED SLM Gen4/Gen4+ modules (with the standard and downlight holders) are Zhaga compatible.

Fortimo LED SLM Gen4/Gen4+ modules selected with the poke-in holder are not Zhaga compatible. However the screwholes available on the holder are the same as the standard versions.

For more information on Zhaga, please refer to the website: www.zhagastandard.org.

Optical design-in

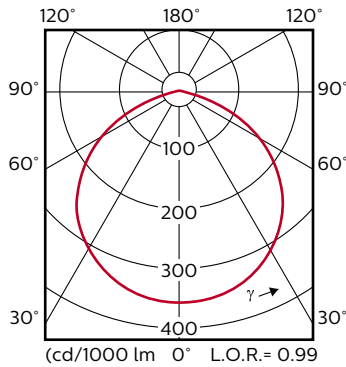

Light distribution diagram

Light distribution

Fortimo LED SLM Gen4/Gen4+ generates a Lambertian beam shape (see light distribution diagram). The secondary optics design should not cover the exit aperture. The IES (or .ldt) files are available via the website www.Philips.com/Technology.

Reflector design limits

The graphs below give an indication of the relation between the diameter of the reflector exit aperture and the minimum beam angle (FWHM) or beam peak intensity that can be achieved with Fortimo LED SLM Gen4/Gen4+ modules.

Peak intensities possible with a reflector height of 60 mm

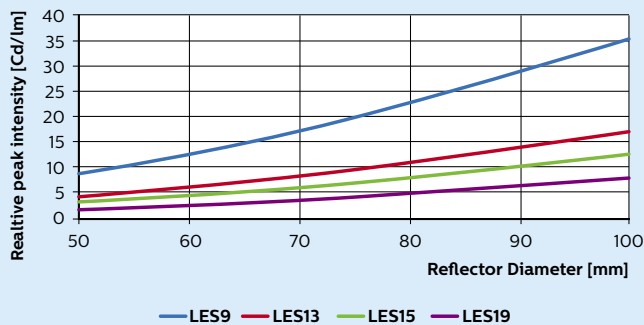

Minimum beam angles possible with a reflector height of 60 mm

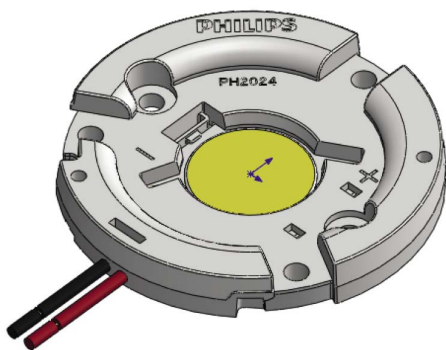
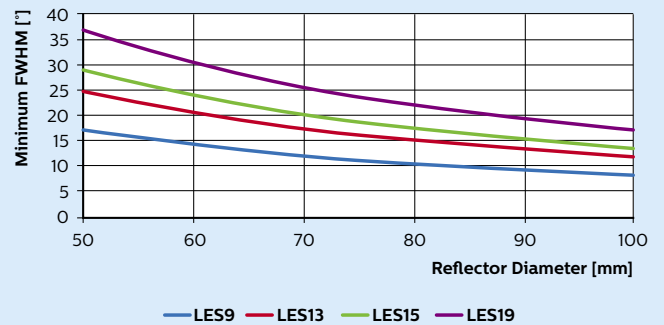

Rayset Origin

Ray sets

The following ray set files are available for customer use, and can be downloaded from www.Philips.com/Technology. All ray set files are available containing 100,000, 500,000 and 5,000,000 rays.

Software	File extension
ASAP	.dis
Light Tools (ASCII)	.ray (zipped)
TracePro/Oslo (ASCII)	.dat (zipped)
Zemax	.dat

The origin of the ray sets is shown in the pictures on the left, and it coincides with the origin of the CAD file:

- X = 0 and Y = 0 at the center of the module.
- Z = 0 at the emitting surface (2 mm below the inner flat surface of the cover).

Color consistency

Color consistency refers to the spread in color points between modules. It is specified in SDCM (Standard Deviation of Color Matching) or MacAdam ellipses, which are identical. The current general specification of all the Fortimo LED SLM Gen4/Gen4+ modules is 3 SDCM. This results in an excellent color consistency performance.

Color targets

The color target points of the Fortimo LED SLM modules are found in the respective datasheets on www.Philips.com/Technology.

Spectral light distribution

The typical spectral light distributions of the Fortimo LED SLM Gen4/Gen4+ colors are shown in the respective datasheets on www.Philips.com/Technology.

Complementary reflector partners

Secondary optics is not part of the Fortimo LED SLM system offering. This is an added-value area for OEMs, offering the possibility to differentiate. However, there are many reflector companies who have a standard portfolio of compatible reflectors available, enabling quick and easy luminaire creation. The table below gives a list of complementary partners offering compatible reflectors for Fortimo LED SLM modules.

The following are examples of reflector products that can be used with the Fortimo LED SLM system. Reference to these products does not necessarily mean they are endorsed by Philips. Philips gives no warranties regarding these products and assumes no legal liability or responsibility for any loss or damage resulting from the use of the information given here.

Complementary reflector partners	
Alux Luxar	www.alux-luxar.de
Jordan	www.jordan-reflektoren.de
NATA	www.nata.cn
Widegerm	www.widegerm.com.hk
LEDIL	www.ledil.com
Almeco	www.almecogroup.com
Sourcing Solutions GmbH	www.hdss-germany.com

Starting characteristics

The Fortimo modules light up milliseconds after being switched on, which is a general characteristic of LEDs.

Mechanical design-in

Fortimo LED SLM Gen4/Gen4+ module dimensions

The Fortimo LED SLM Gen4/Gen4+ modules comply with the Zhaga* book 3 for LED accent lighting modules. 3D CAD files can be downloaded from our website www.Philips.com/Technology.

Basic dimensions for each module can also be found in the datasheets which are also available at the afore mentioned website.

*Measurements showing compliancy to Zhaga book 3 version 1.2 have been done on the 3000 lm L15 module with the standard holder.

Recommended torque

The recommended torque for mechanical fixation of the Fortimo LED SLM Gen4/Gen4+ modules to the heat sink is 0.6 Nm (assuming pre-taped holes are present in the heat sink).

Wires for SLM Gen4/Gen4+ Poke-in versions

The Poke-in holder supports 18-22 AWG (0.35 - 0.75mm²) solid, fused and stranded wires. It can be placed using M3 type screws.

Note:

For the poke-in holder for the largest size CoBs (4500lm, CrispWhite 3800lm, Food Warm White and Food Premium Red), stranded wires cannot be used. Please use solid/fused wires.

Thermal design-in

The critical thermal management points for the LED module are set out in this chapter in order to facilitate the design-in of Fortimo LED spotlight modules (SLM). If these thermal points are taken into account, this will help to ensure optimum performance and lifetime of the LED system.

Optimum performance

To ensure optimum performance, the Fortimo LED SLM system must operate within specified temperature limits.

Test requirements

Measurements, e.g. of temperature, luminous flux and power, are reliable once the luminaire is thermally stable, which may take between 0.5 and 2 hours, and is defined as at least 3 readings of light output and electrical power over a period of 30 minutes taken 15 minutes apart with stability less than 0.5%. The time depends on the thermal capacity of the luminaire (see also the relevant clauses in IEC 60598-1).

Note:

Thermal stability can be considered if the temperature changes are less than 1 °C over three measurements taken 15 minutes apart. Measurements must be performed using thermocouples that are firmly glued to the surface (and not, for example, secured with adhesive tape).

Critical measurement points

Because LEDs are temperature sensitive, LED modules require a different approach with respect to the maximum permissible component temperature. This is different to most other types of conventional light sources.

For LEDs the junction temperature is the critical factor for operation. Since there is a direct relation between the case temperature and the LED junction temperature, it is sufficient to measure the aluminum casing of the LED module at its critical point. The critical point is on the rear surface of the LED module, as shown in the figure on the left. If the case temperature (T_c) at the critical measurement point exceeds the recommended maximum temperature, the performance of the LEDs will be adversely affected, for example in terms of light output, lifetime or lumen maintenance.

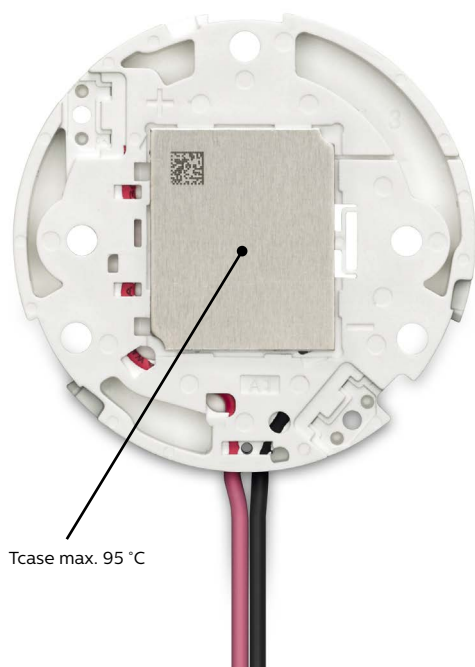

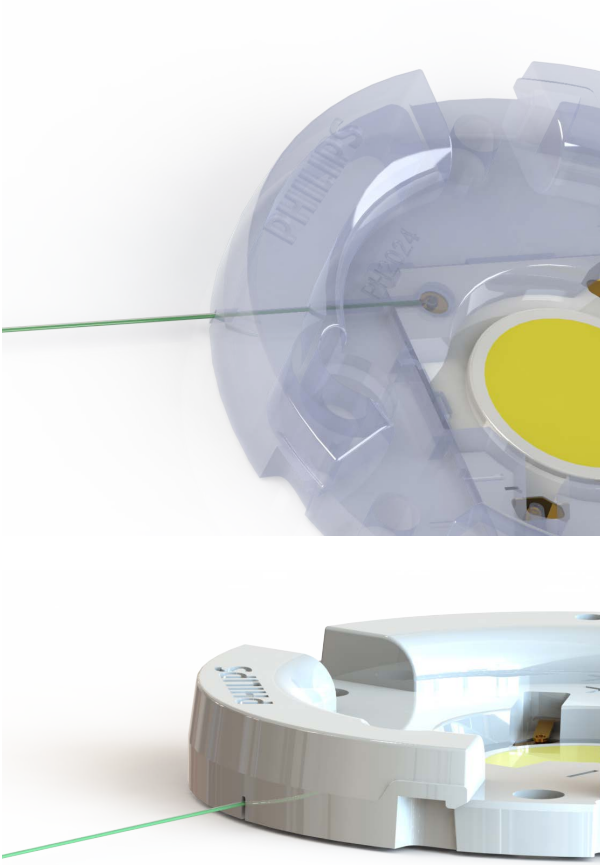

Thermocouple Wire fed through provision in holder

To aid easy design-in of the Fortimo LED SLM Gen4/Gen4+, a Tsense point is introduced at the top side of the LED module. The Tcase point at the back still remains leading. However, under certain circumstances, the temperature measurements on the Tsense point can be used to predict the temperature of the Tcase point at the back of the module. For this purpose, there is a provision in the SLM holder (with the exception of the poke-in version) to feed through a thin thermal couple wire. The correlation between the Tsense point and the Tcase point is influenced by the quality and performance of the thermal interface with the heat sink and the type and geometry of the heat sink. The correlation between Tsense and Tcase has been calculated based on laboratory test with thermal paste and heat sinks with at least 3mm heat sink base thickness. If these conditions are the same, then a difference of 0.3°C/W can be used. Results may vary case by case, and it is best if the measurement reference is made at the customer, using the luminaire in question. It is also important to note that the Tcase temperature is always leading. If support is needed please ask your Philips representative about our design-in service.

Tc-nominal and Tc-max

With the introduction of Fortimo LED SLM Gen4/Gen4+ the luminaire manufacturer is enabled to make their luminaire even more compact due to a smaller heat sink. For this, Tc-max has been introduced. The Tc-max value for the Fortimo LED SLM Gen4/Gen4+ is set to 95 °C and it is the maximum temperature at which the Philips Fortimo LED SLM Gen4/Gen4+ modules can be operated. Please contact your Philips representative for detailed product specs in that case. At Tc-nominal of 85 °C all the specifications mentioned in the Fortimo LED SLM Gen4/Gen4+ commercial leaflet, datasheets and design-in guide are valid and a 5 year system warranty is applicable in combination with a Philips Xitanium LED driver.



Warning:

The Fortimo LED SLM Gen4/Gen4+ does not incorporate the NTC feature of the Fortimo LED SLM Gen3 when connected to a Xitanium LED driver. Special care needs to be taken for active cooled solutions. Please ensure that your operating current is within limits for the CoB.

Note:

With no Rset connected to the driver, the driver goes to its default current (specified in the driver datasheet). This default current must also be less than the maximum current specified for the module.

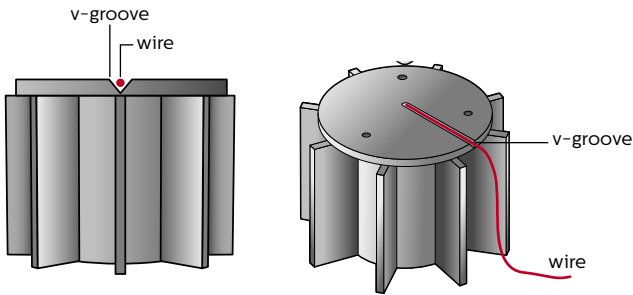

Thin v-groove in the heat sink to embed a thermocouple

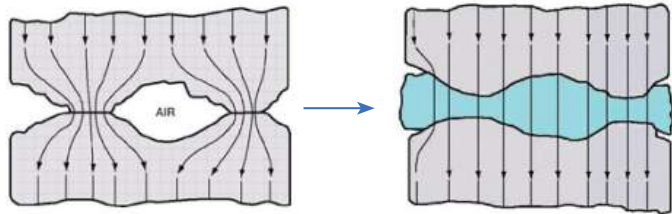

The working principle of thermal interface material (TIM)

How to measure the critical temperature point T_c

The T_c temperature can be measured by making a thin v-groove or a small drill hole in the heat sink to reach the bottom of the LED module. Be sure to measure the temperature of the bottom of the module and not of the thermal interface material (TIM).

Thermal interface material

The function of a thermal interface material is to reduce thermal impedance between the LED module and the heat sink. The thermal interface material replaces air, which is a thermal insulator, by filling the gaps with material that has better thermal conductivity. This is shown diagrammatically in the figure on the left.

In general:

- Thermal paste performs better than thermal pads.
- The lower the thermal impedance the better.
- The thickness of the TIM should relate to the surface roughness and flatness of the used heatsink.

Due to the small footprint of the Fortimo SLM Gen4/Gen4+, it is more sensitive to roughness and surface quality of the heat sink counter surface. It is highly recommended to have this surface clean and free of burs before applying the thermal interface material and the SLM module.

The following are suggestions for thermal interface material products that can be used with the Fortimo LED SLM module. Reference to these products does not necessarily mean they are endorsed by Philips. Philips gives no warranties regarding these products and assumes no legal liability or responsibility for any loss or damage resulting from the use of the information given here.

For the Fortimo LED SLM Gen4/Gen4+ it is recommended to use a thermal paste or phase change material as Thermal Interface Material (TIM). Please also be aware that an electrically insulating phase change material will introduce a thermal penalty compared to non-electrically isolating phase change material. Thick thermal interface materials are not recommended.

Thermal interface partners

Laird Technologies	www.lairdtech.com
The Bergquist Company	www.bergquistcompany.com

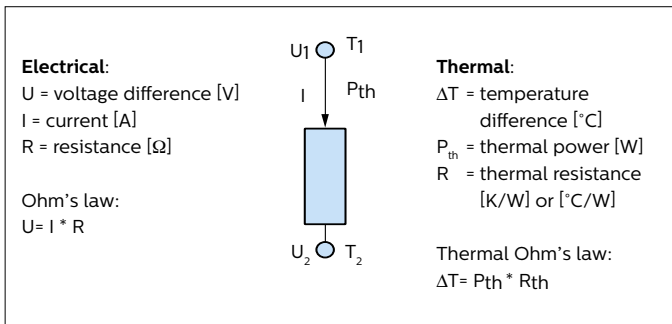

Electrical and thermal analogy

Electrical and thermal analogy

Standard static thermal situations can be modeled using ‘thermal resistances’. These resistances behave like electrical resistances. The analogy between electrical and thermal resistances is explained in the figure entitled ‘Electrical and thermal analogy’ on the left. The electrical units are shown on the left, while the thermal equivalents are given on the right. With a known voltage difference at a certain current it is possible to calculate the electrical resistance using Ohm’s law. The same applies for a thermal resistance. If the temperature difference and the thermal power are known, the thermal resistance can be calculated using the thermal Ohm’s law. Please note that using the concept of thermal resistances is a strong simplification of the actual physics of heat transfer, to aid in understanding of heat flow and temperature.

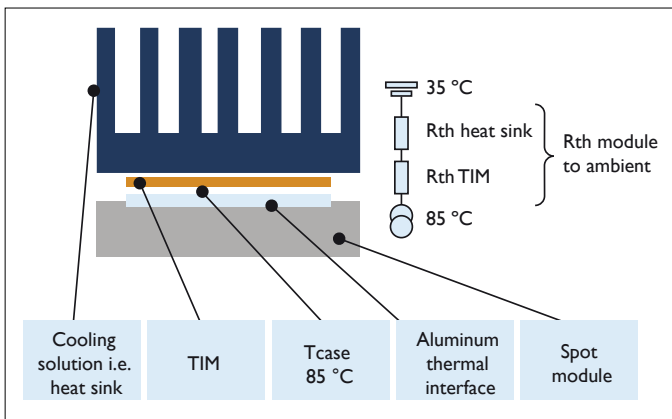

Thermal model

Thermal model

A thermal model that can be used to determine the required thermal performance of the cooling solution for the LED module is shown in the figure on the left.

A simplified model of the thermal path from LED module to ambient; Tc of 85 °C is used as an example.

Thermal design of a heat sink

A successful thermal design-in means that the Tc temperatures of the LED module is within thermal specifications at given maximum operating ambient of the luminaire.

Remarks:

- For track spot lighting applications, a minimum of 25 °C design ambient is recommended.
- For recessed spot lighting applications, a minimum of 35 °C design ambient is recommended.

If the expected maximum operating ambient for the luminaire is <25 °C ambient, the luminaire still needs to be tested within thermal specifications of Tcase nominal in a lab environment at 25 °C ambient.



Warning:

The maximum temperature difference between Tc and Tambient should not exceed 60 °C for SLM Gen4/Gen4+, otherwise it could lead to a reduction in the lifetime of the system.



Warning:

Due to the increased Tcase nominal temperature of the Fortimo LED SLM Gen4/Gen4+ to 85 °C, it is important to take into account the maximum touchable metal surface temperatures of the luminaire during design. With such a high Tcase temperature the maximum temperature for touch safety can easily be exceeded.

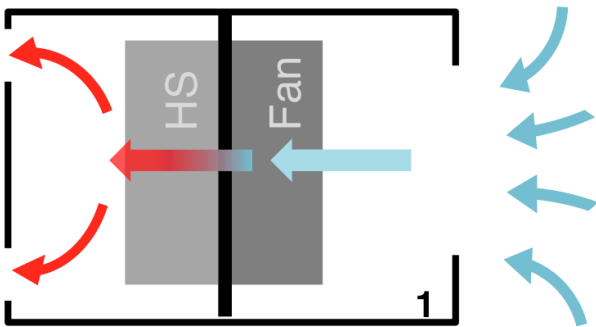

1. Design guidelines for active cooling solutions

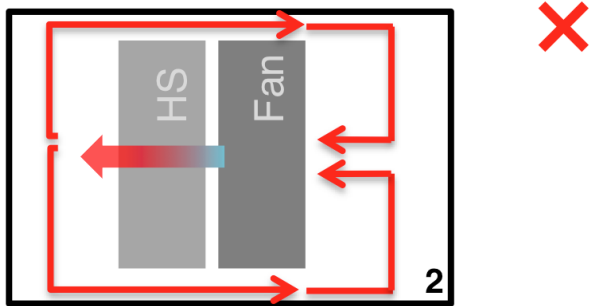

2. Design guidelines for active cooling solutions

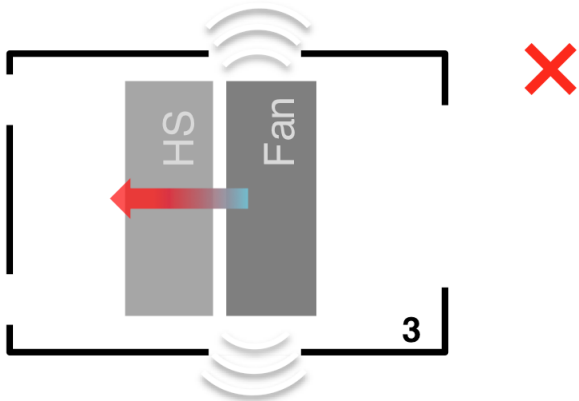

3. Design guidelines for active cooling solutions

Active and passive cooling

In theory two thermal solutions are possible.

Active cooling

With this method the air is forced to flow by means of a fan or membrane, which enhances the thermal dissipating capacity of the heat sink. As a result, a smaller heat sink can be used and the orientation of the heat sink has less impact on the thermal performance. A potential side effect is that the fan or membrane might produce noise and consume extra energy.

Furthermore, the specified lifetime of the fan should match that of the application.

Design guidelines for active cooling

Design guidelines for active cooling include:

- The luminaire should be equipped with an inlet for cool air and an outlet for hot air (Image 1).
- The airflow from the inlet to the outlet should be smooth and without restriction in order to limit vibration, recirculation and noise.
- Recirculation of hot air (Image 2) inside the luminaire should be prevented, as this will lead to a lower thermal performance and higher noise level.
- Unnecessary openings near the fan in the luminaire housing (Image 3) should be avoided in order to help contain any noise from the fan.

Passive cooling

Passive cooling systems are based on the fact that hot air moves upwards, thus creating airflow along the surfaces. This is called natural convection. There are many standard heat sinks available, but it is also possible to design your own heat sink.

In general, a passive cooling solution requires a larger heat sink than an active cooling solution.

Design guidelines for passive cooling

Before starting to perform any calculations, an important point to consider is the airflow. In general hot air moves upwards at a relatively low speed. The shape and position of the heat sink will affect the airflow. Ideally, the fins should be parallel to the direction of airflow. Closure of the top of the profile will reduce the cooling capacity of the heat sink and should therefore be avoided during design and installation.

Some additional design guidelines for passive cooling include:

- Limit the number of thermal interfaces in the thermal path from module to ambient.
- Thick fins conduct heat better than thin fins.
- Large spacing between fins is better than small spacing between fins.
- Make cooling surfaces more effective by using proper conductive materials, appropriate thickness and correct fin orientation.
- Thermal radiation plays a significant role => anodized or powder-coated surfaces are preferable to blank surfaces.

Complementary thermal solution partners

Thermal solutions do not form part of the Fortimo LED SLM system offering. This is an added-value area for OEMs, offering the possibility to differentiate. However, there are many thermal solution companies who have a standard portfolio of compatible heat sinks available, enabling quick and easy luminaire creation. The table below gives a list of complementary partners offering compatible cooling systems for Fortimo LED SLM modules. An up-to-date list can be found on our website: www.philips.com/fortimo.

Reference to these products does not necessarily mean they are endorsed by Philips. Philips makes no warranties regarding these products and assumes no legal liability or responsibility for any loss or damage resulting from the use of the information given here.

Complementary heat sink partner	
Sunon	www.sunon.com
AVC	www.avc.com.tw
Nuventix	www.nuventix.com
Wisefull	www.wisefull.com
MechaTronix	www.mechatronix-asia.com

Electrical design-in and flexibility

Connection to the mains supply

The mains supply must be connected to the LED driver (Line and Neutral can be interchanged).

Double Isolated Drivers

The Fortimo LED SLM G4 products are designed to be used with double isolated drivers. This allows for an easier design-in with no isolation required on the luminaire.

Tune the luminaire's flux (lm) and efficacy (lm/W)

The LED SLM specifications are provided under nominal conditions, like nominal flux at nominal current. It is however possible to deviate from this nominal current. By altering the current, we can obtain different flux outputs. At the same time, the required forward voltage (Vf) also changes, leading to a change in the efficacy (lm/W). The following sections explain the impact and boundaries.

Effect of Choosing a different current value

In case the customer chooses to set the current (either by programming or by applying an Rset resistor) other than nominal, the lifetime and reliability of the LED SLM must be taken into account. The following current regions can be distinguished:

1. Current < nominal current* (mA)
 - a. Efficacy (lm/W) higher than nominal value
lumen output (lm) lower than nominal value
 - b. Lifetime > 50,000 hours
2. Current between nominal current and absolute maximum current** (mA). Your warranty may be affected in this case.
 - a. Efficacy (lm/W) lower than nominal value
lumen output (lm) higher than nominal value
 - b. Lifetime **may be** < 50,000 hours
3. Current > absolute maximum current: do not exceed the absolute maximum current as this can lead your LED SLM module to failure. No warranty applicable in this case.

Note:

You must check if your chosen operating point falls within the warranty window stated in the datasheets along with the flux tuning graphs as shown on the left. The warranty is applicable for the Philips Fortimo LED SLM modules for 1 switching cycle per day in combination with a SELV driver.

The rated average life is based on engineering data testing and probability analysis. The hours are at the L70B50 point.

* Nominal current at which performance and lifetime is specified

** Maximum current tested for safety

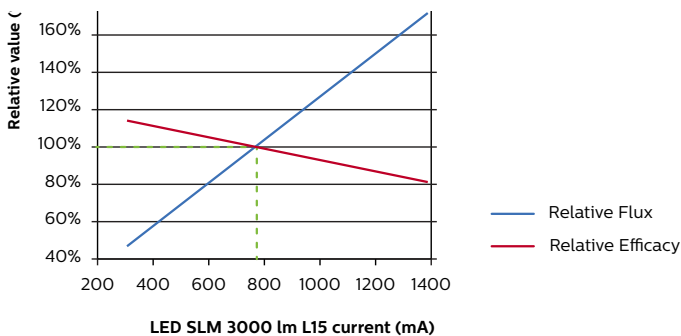

Example graph showing flux and efficacy as a function of current

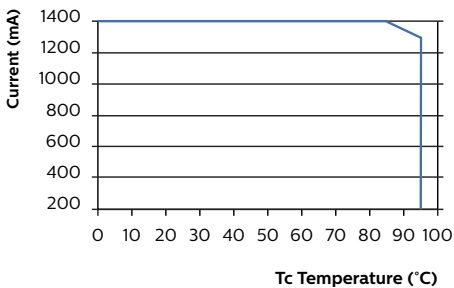

Example warranty window



Poke-in Rset inserted in a driver



JST Rset inserted in a driver

Set the output current via Rset

By making use of a resistor component with a determined Ohmic value you can set the required current for your LED module. This component can be a leaded standard 1% tolerance resistor of e.g. 0.125 W or 0.25 W, 50 V. The Rset will not be part of the electrical chain driving the module.

An example of a resistor placed into the drivers' input is shown on the left.

Three different Rset resistors are utilized in the Xitanium Indoor Spot and Downlight LED driver portfolio:

Rset1 (older drivers)*; allows output current setting up to 700 mA

Rset2; allows output current setting up to 2000 mA

LEDset: Allows output current setting upto 8000 mA

In all documentation, Rset may refer to either Rset1, Rset2 or LEDset, depending on the driver type. Please check the driver datasheet for which Rset the driver you use reads. You can find this at www.Philips.com/Technology.

Note:

The Rset must be inserted such that there is no mechanical pressure on it from the driver casing being closed.

Rset1 and Rset2 use different pins on the driver (and on the JST connector). The Rset1 and Rset2 values with the corresponding drive currents are shown in following tables. It is advised to select the nearest lower resistor value that is available to you, if the exact determined value is not at hand.

* All future drivers will support LEDset.

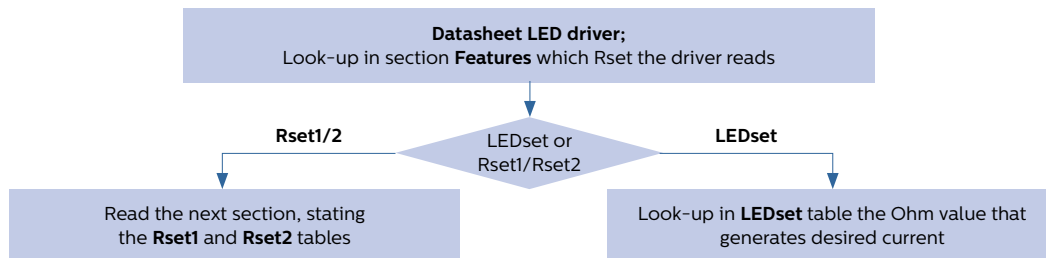

Note on E-series: in electronics, international standard IEC 60063 defines preferred number series for amongst others resistors. It subdivides the interval between subsequent values from 1 to 10 into 6, 12, 24, 48, 96 etc. steps. These subdivisions ensure that when some arbitrary value is replaced with the nearest preferred number, the maximum relative error will be on the order of 20%, 10%, 5%, 1% etc.

LEDset – E96 series: table with E96 resistor values

LEDset [Ω]	Idrive [mA]	LEDset [Ω]	Iset [mA]	LEDset [Ω]	Iset [mA]	LEDset [Ω]	Iset [mA]
open	driver's default current	23700	211	11000	455	5110	978
49100	102	23600	212	10700	467	4910	1018
48700	103	23200	216	10500	476	4870	1027
47500	105	22100	226	10200	490	4750	1053
46400	108	21600	231	10000	500	4640	1078
45300	110	21000	238	9760	512	4530	1104
44200	113	20500	244	9530	525	4420	1131
43200	116	20000	250	9310	537	4320	1157
42200	118	19600	255	9090	550	4220	1185
41200	121	19100	262	8870	564	4120	1214
40200	124	18700	267	8660	577	4020	1244
39200	128	18200	275	8450	592	3920	1276
38300	131	17800	281	8250	606	3830	1305
37400	134	17400	287	8060	620	3740	1337
36500	137	16900	296	7870	635	3650	1370
35700	140	16500	303	7680	651	3570	1401
34800	144	16200	309	7500	667	3480	1437
34000	147	15800	316	7320	683	3400	1471
33200	151	15400	325	7150	699	3320	1506
32400	154	15000	333	6980	716	3240	1543
31600	158	14700	340	6810	734	3160	1582
30900	162	14300	350	6650	752	3090	1618
30100	166	14000	357	6490	770	3010	1661
29400	170	13700	365	6340	789	2940	1701
28700	174	13300	376	6190	808	2870	1742
28000	179	13000	385	6040	828	2800	1786
27400	182	12700	394	5900	847	2740	1825
26700	187	12400	403	5760	868	2670	1873
26100	192	12100	413	5620	890	2610	1916
25500	196	11800	424	5490	911	2550	1961
24900	201	11500	435	5360	933	2490	2008
24300	206	11300	442	5230	956	short	driver's max. current

Datasheet LED driver;
Look-up in section **Features** which Rset the driver reads

If both Rset1 and Rset2 are supported, Rset2 is advised for future compatibility

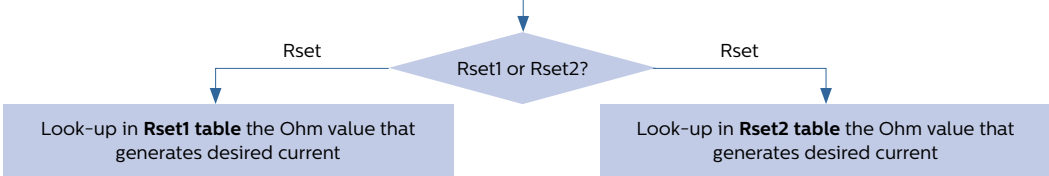

Note on E-series: in electronics, international standard IEC 60063 defines preferred number series for amongst others resistors. It subdivides the interval between subsequent values from 1 to 10 into 6, 12, 24, 48, 96 etc. steps. These subdivisions ensure that when some arbitrary value is replaced with the nearest preferred number, the maximum relative error will be on the order of 20%, 10%, 5%, 1% etc.

Note: next page shows extended Rset2 table: E96 values, stating smaller increments

Rset1 – E24 series

Ret1 [Ω]	Iset [mA]	Ret1 [Ω]	Iset [mA]	Ret1 [Ω]	Iset [mA]	Ret1 [Ω]	Iset [mA]
39	200	510	292	6k8	583	91k	690
43	201	560	300	7k5	591	100k	691
47	202	620	309	8k2	599	110k	692
51	203	680	318	9k1	60	120k	693
56	204	750	327	10k	614	130k	693
62	206	820	336	11k	621	150k	695
68	208	910	347	12k	627	160k	695
75	209	1k	358	13k	632	180k	696
82	210	1k1	369	15k	640	200k	696
91	212	1k2	379	16k	643	220k	697
100	215	1k3	388	18k	649	240k	697
110	217	1k5	406	20k	654	270k	698
120	219	1k6	414	22k	658	300k	698
130	221	1k8	429	24k	661	330k	698
150	226	2k	442	27k	665	360k	699
160	228	2k2	455	30k	669	390k	699
180	232	2k4	466	33k	671	430k	699
200	236	2k7	481	36k	674	470k	699
220	240	3k	494	39k	676	510k	699
240	244	3k3	505	43k	678	560k	700
270	250	3k6	517	47k	680	620k	700
300	256	3k9	525	51k	682	680k	700
330	261	4k3	536	56k	683	750k	700
360	267	4k7	546	62k	685	820k	700
390	272	5k1	555	68k	686	910k	700
430	279	5k6	564	75k	688	1M	700
470	286	6k2	574	82k	689	No Rset	default

Rset2 – E24 series

Ret1 [Ω]	Iset [mA]	Ret1 [Ω]	Iset [mA]	Ret1 [Ω]	Iset [mA]	Ret1 [Ω]	Iset [mA]
short	100	430	245	2k	733	9k1	1558
100	100	470	261	2k2	780	10k	1604
110	106	510	277	2k4	823	11k	1653
120	111	560	297	2k7	884	12k	1694
130	116	620	318	3k	941	13k	1730
150	121	680	340	3k3	993	15k	1793
160	130	750	368	3k6	1042	16k	1817
180	13	820	392	3k9	1086	18k	1864
200	146	910	422	4k3	1143	20k	1902
220	155	1k	452	4k7	1192	22k	1935
240	166	1k1	485	5k1	1238	24k	1965
270	176	1k2	515	5k6	1293	27k	2000
300	190	1k3	545	6k2	1350	No Rset	default
330	204	1k5	602	6k8	1402		
360	215	1k6	632	7k5	1454		
390	228	1k8	684	8k2	1503		

Rset priority behavior for drivers that read both Rset1 and Rset2

Rset1	Rset2	Driver status
Open	Open	Driver's default current (see datasheet)
Rset	Open	Rset1
Open	Rset	Rset2
Rset	Rset	Rset2
Short	Open	Rset1 (driver's minimum current, see datasheet)
Short	Short	Rset2 (driver's minimum current, see datasheet)
Open	Short	Rset2 (driver's minimum current, see datasheet)

Please refer to the datasheet of the driver you use to find which Rset or Rsets the driver actually reads.

Rset2 – E96 series: table with E96 resistor values, stating smaller increments but covering same range as the E24 series on previous page

Rset2 [Ω]	Iset [mA]	Rset2 [Ω]	Iset [mA]	Rset2 [Ω]	Iset [mA]	Rset2 [Ω]	Iset [mA]	Rset2 [Ω]	Iset [mA]	Rset2 [Ω]	Iset [mA]
short	min.	255	171	665	335	1740	669	4530	1171	11800	1686
100	100	261	173	681	341	1780	679	4640	1185	12100	1698
102	101	267	175	698	347	1820	689	4750	1198	12400	1708
105	103	274	178	715	354	1870	701	4870	1212	12700	1719
107	104	280	181	732	361	1910	711	4910	1216	13000	1730
110	105	287	184	750	368	1960	724	5110	1239	13300	1739
113	107	294	187	768	374	2000	733	5230	1253	13700	1752
115	108	301	191	787	381	2050	745	5360	1267	14000	1761
118	110	309	194	806	387	2100	757	5490	1281	14300	1771
121	111	316	197	825	394	2160	770	5620	1295	14700	1783
124	113	324	201	845	400	2210	782	5760	1308	15000	1793
127	115	332	204	866	407	2320	806	5900	1322	15400	1802
130	116	340	207	887	414	2360	815	6040	1335	15800	1812
133	118	348	210	909	422	2370	817	6190	1349	16200	1822
137	119	357	214	931	429	2430	829	6340	1362	16500	1829
140	120	365	217	953	436	2490	841	6490	1375	16900	1838
143	122	374	221	976	444	2550	853	6650	1389	17400	1850
147	123	383	225	1000	452	2610	865	6810	1403	17800	1859
150	125	392	229	1020	459	2670	877	6980	1415	18200	1867
154	127	402	233	1050	469	2740	891	7150	1428	18700	1877
158	129	412	237	1070	475	2800	903	7320	1441	19100	1885
162	131	422	241	1100	485	2870	916	7500	1454	19600	1894
165	132	432	246	1130	494	2940	929	7680	1467	20000	1902
169	134	442	250	1150	500	3010	943	7870	1480	20500	1910
174	136	453	254	1180	509	3090	956	8060	1493	21000	1918
178	137	464	259	1210	518	3160	968	8250	1506	21600	1928
182	139	475	263	1240	527	3240	982	8450	1518	22100	1936
187	141	487	268	1270	536	3320	996	8660	1531	23200	1952
191	143	491	270	1300	545	3400	1009	8870	1544	23600	1959
196	145	511	278	1330	554	3480	1022	9090	1557	23700	1960
200	146	523	282	1370	565	3570	1037	9310	1569	24300	1968
205	148	536	287	1400	574	3650	1049	9530	1580	24900	1975
210	151	549	292	1430	582	3740	1062	9760	1592	25500	1982
216	153	562	297	1470	594	3830	1075	10000	1604	26100	1989
221	155	576	302	1500	602	3920	1088	10200	1614	26700	1996
232	161	590	307	1540	614	4020	1103	10500	1629	27000	2000
236	163	604	313	1580	626	4120	1117	10700	1639	open	default
237	164	619	318	1620	638	4220	1131	11000	1653		
243	167	634	323	1650	645	4320	1145	11300	1666		
249	169	649	329	1690	656	4420	1158	11500	1674		



Warning:

Please note that changing the rset on the module changes the current and voltage at which the module operates. You may have to adapt your design accordingly. In case no Rset is used, please check the default setting of your driver. This current may be higher than what your CoB can handle!

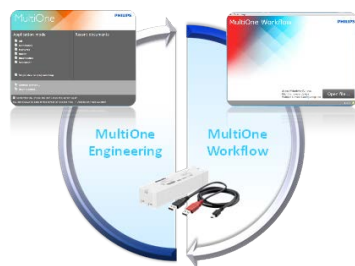

How to... Program the output current

One interface – connecting to indoor & outdoor, LED & conventional

The Xitanium TD drivers offer a full range of controls, enabling customizable luminaire design and performance. It is possible to control light output levels, preset dimming protocols and set system specifications in the factory and even in the complete installations in the field. This can be done with the Philips MultiOne configurator software. The MultiOne configurator software is an intuitive tool that unlocks the full potential of all programmable drivers from Philips, ensuring that the driver performance matches the needs of the lighting solution. It offers unprecedented flexibility, before, during and after the product installation.

For more information and latest version please visit www.Philips.com/multione.

This site contains detailed information on how to install the software and how to program the driver.

Xitanium Indoor Spot and Downlight LED drivers

For the drivers, the same documentation philosophy holds as for the LED modules, meaning that also three documents make up the full information set of the drivers.

For detailed info, please refer to these documents for your driver on www.Philips.com/Technology.

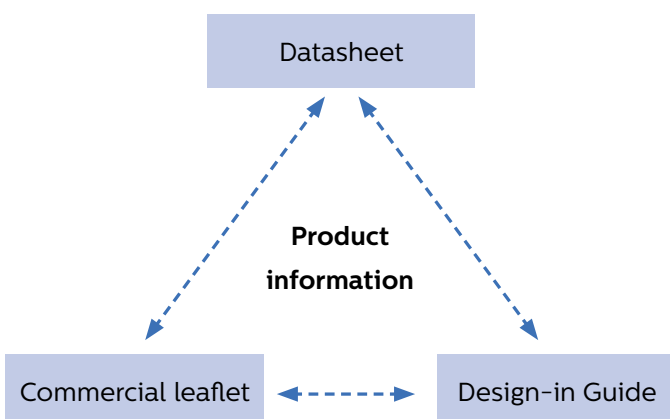

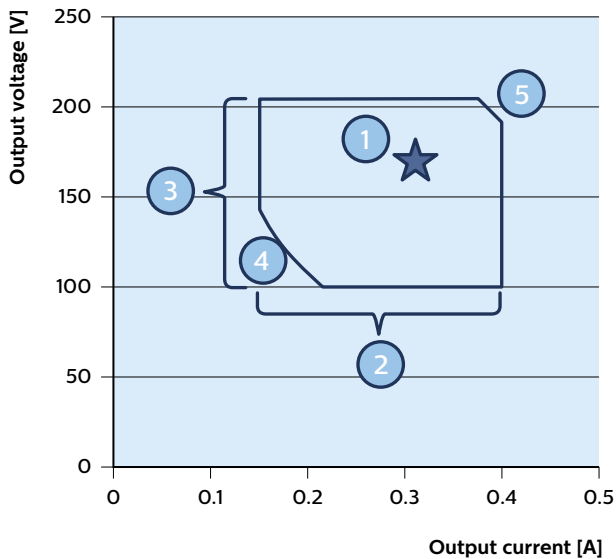

1. Required operating point
2. Current can be set to needs within range
3. Driver adapts to required voltage, given it fits range
4. Driver minimum power limit
5. Driver maximum power limit

Example Operating window of the Xitanium driver

Xitanium Driver Operating window

LED technology is rapidly evolving. Using more efficient LEDs in a next generation means the same light output can be achieved with lower currents. At the same time, LEDs can be driven at different currents levels based on the application requirement. Typically, LED drivers are available in discrete current levels e. g. 350 mA, 530 mA or 700 mA. It is often necessary to replace a driver when more efficient LEDs become available.

One of the key features of the Xitanium LED drivers is the adjustable output current (AOC), offering flexibility and future-proof luminaire design. The Xitanium drivers can operate in a certain “operating window”. This window is defined by the maximum and minimum voltage and current that the driver can handle. An example of an operating window is shown on the left. The area indicates the possible current/voltage combinations. The current you select will depend on the type and manufacturer of the LEDs or the specific LED configuration of the PCB design. The operating window of every driver can be found in the associated driver datasheets which can be downloaded on following website: www.Philips.com/Technology.

Note:

By means of dimming it is possible to go below the minimum value of the specified output current. The output current of these drivers can be set in two ways.

1. By connecting a specific resistor value to the driver’s Rset input.
2. TD driver versions can be programmed via the MultiOne interface in order to set the desired current. (www.Philips.com/multione).

How to determine what value the output current should be set at will be explained in the next sections.

To Select an Appropriate Driver

Depending on your requirements, several drivers can be a solution for you. The following steps can help you in selecting a driver. For a complete overview of the available drivers, please refer to the download section of www.Philips.com/Technology.

1. Determine your required driver current (I_{drive}) and voltage (V_f).
2. Calculate the required power (P_{drive}) where $P_{drive} = V_f \times I_{drive}$ (W).
3. Select the datasheets from the website mentioned above based on the driver having a power greater than the required power. For Fortimo SLM Gen4/Gen4+, only SELV drivers can be selected.
4. Does the required current fit the current range of the driver? The current range of the driver can be seen in the name itself. For example, in the 17 W LH 0.3-1 A 24 V TD/Is 230 V, the minimum driver current is 0.3 A and maximum is 1 A.
 - $I_{driver\ min} \leq I_{drive} \leq I_{driver\ max}$?
5. Does the required voltage fit the voltage range of the driver? The voltage range of the driver can be seen in the name itself. For example, in the 17 W LH 0.3-1 A 24 V TD/Is 230 V, the maximum driver voltage is 24 V and the minimum is 50% of this value, which is 12 V in this case.
 - $V_{driver\ min} \leq V_f \leq V_{driver\ max}$?
6. Does the required power fit the power range of the driver?

In the naming of the driver, you can see the maximum power possible. For example, in the 17 W LH 0.3-1 A 24 V TD/Is 230 V, the maximum power is 17 W. The minimum power is defined as $I_{driver\ min} \times V_{driver\ min}$.

 - $P_{driver\ min} \leq P_{drive} \leq P_{driver\ max}$?
7. Choose your preferred dimming. Please refer to the section about naming of the drivers to know what the naming tells you about the possibilities.

Compatible Drivers with SLM Gen4/Gen4+

In the following graph, you can see the various operating windows for the different Philips Xitanium drivers. Based on the above explained rules, you can now choose the appropriate driver for your SLM module operating point. A list of different drivers that belong to the windows explained is provided after. In case of queries, please contact your Philips representative.

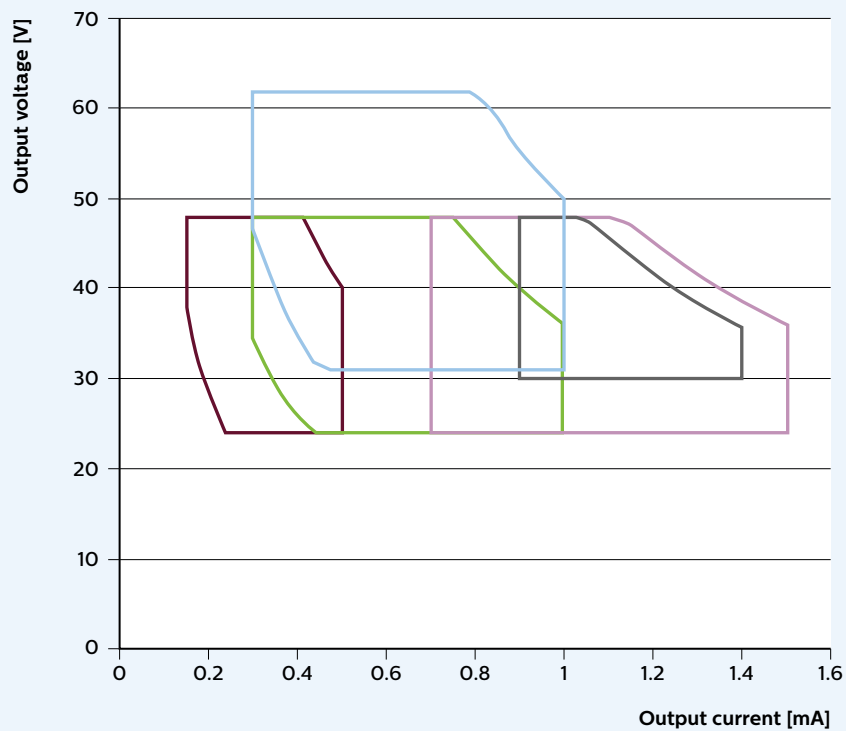

Driver	12NC	EOC
Window: Xitanium 20 W 0.15-0.5 A 48 V		
Xitanium 20W/m 0.15-0.5A 48V 230V	9290 008 93806	8718291 76663600
Xitanium 20W LH 0.15-0.5A 48V TD/I 230V	9290 009 04006	8718291 78234600
Window: Xitanium 36 W 0.3-1.05 A 48 V		
Xitanium 36W/m 0.3-1.05A 48V 230V	9290 008 81806	8718291 75027700
Window: Xitanium 36 W 0.3-1 A 48 V		
Xitanium 36W LH 0.3-1A 48V I 230V	9290 008 38903	8718291 66644800
Xitanium 36W/s 0.3-1A 48V 230V	9290 008 39003	8718291 69786200
Xitanium 36W LH 0.3-1A 48V TD/I 230V	9290 008 70806	8718291 72903700
Xitanium 36W/s 0.3-1A 48V TD 230V	9290 008 97606	8718291 77094700
Window: Xitanium 50 W 0.7-1.5 A 48 V		
Xitanium 50W LH 0.7-1.5A 48V TD/I 230V	9290 009 04106	8718291 78236000
Window: Xitanium 50 W 0.3-1 A 62 V		
Xitanium 50W SH 0.3-1A 62V I 230V	9290 008 53703	8718291 67621800
Xitanium 50W LH 0.3-1A 62V TD/TE/I 230V	9290 006 17103	8718291 11947000
Xitanium 50W SH 0.3-1A 62V TD/TE/I 230V	9290 006 17203	8718291 11948700
Window: Xitanium 50 W 0.9-1.4 A 48 V		
Xitanium 50W/s 0.9-1.4A 48V 230V	9290 008 99306	8718291 77758800

Reliability

Lumen maintenance

L70B50 @ 50,000 hours

The quality of the LED SLM portfolio is backed by the Philips' claim of B50L70 @ 50,000 hours. This means that at 50,000 hours of operation at least 50% of the LEDs' population will emit at least 70% of its original amount of lumens.

This is contrary to conventional light sources, where some time after Service Life Hours the conventional light source emits no light at all.

In this section the example graphs show the estimated lumen depreciation curves for different percentage of the population and at nominal Tc temperatures. The actual data for the LED SLM modules can be found in the associated datasheet at www.Philips.com/Technology.

Average rated life is based on engineering data testing and probability analysis. The Fortimo LED SLM Gen4/Gen4+ modules are specified to reach L70B50 for the nominal specifications.

Lumen maintenance for B10 and B50

The example graph is showing the lumen maintenance (% of initial lumen over time) for B50 (50% of the population) and B10 (90% of the population).

Please look up the actual lumen maintenance graph in the associated datasheet of the Fortimo LED SLM you are using at www.Philips.com/Technology.

3000 Lm L15

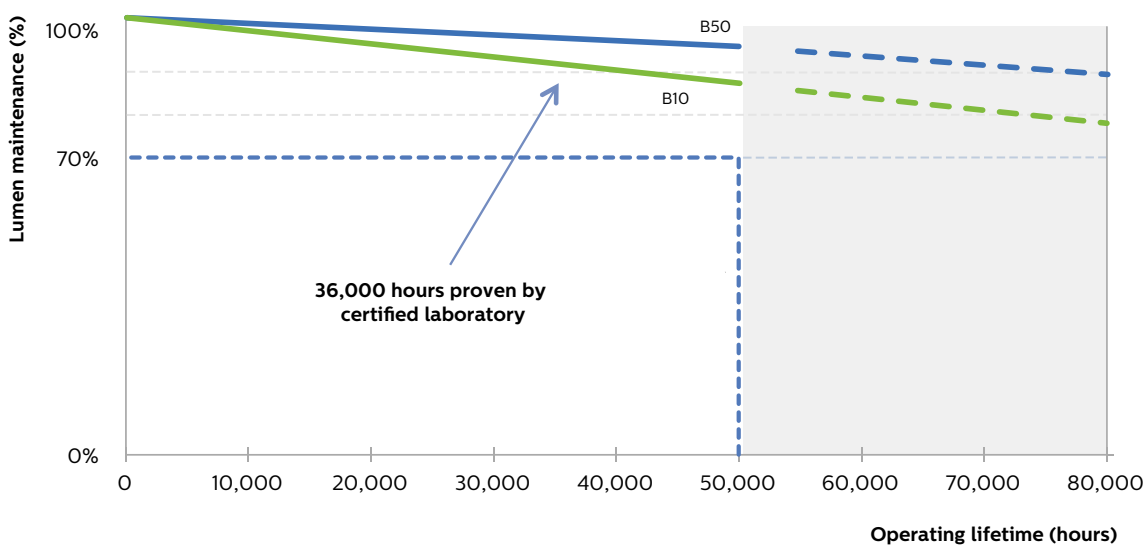

Example lumen maintenance as a function of operating hours for B10 and B50 at Tc nominal

Controllability



OccuSwitch DALI



ActiLume DALI



ToBeTouched DALI

Dimming the Philips Fortimo LED SLM system

As a system, the Philips Fortimo LED SLM and Xitanium dimmable drivers support dimming between 100% and 1%, depending on the driver specification. The Xitanium driver range supports various dimming protocols. Please refer to the driver design-in guide for more detailed information.

Philips lighting control systems

For DALI systems we recommend:

- OccuSwitch DALI
- ActiLume DALI
- ToBeTouched DALI
- Dynalite solutions (via Philips VAR network)

Further information about our entire portfolio of control products is available at: www.Philips.com/lightingcontrols.

Complementary partners

Complementary reflector partners

Alux Luxar	www.alux-luxar.de
Jordan	www.jordan-reflektoren.de
NATA	www.nata.cn
Widegerm	www.widegerm.com.hk
LEDIL	www.ledil.com
Almecco	www.almecogroup.com
Sourcing Solutions GmbH	www.hdss-germany.com

Thermal interface partners

Laird Technologies	www.lairdtech.com
The Bergquist Company	www.bergquistcompany.com

Complementary heat sink partner

Sunon	www.sunon.com
AVC	www.avc.com.tw
Nuventix	www.nuventix.com
Wisefull	www.wisefull.com
MechaTronix	www.mechatronix-asia.com

Compliance and approval

Compliance and approbation

The modules bear the CE mark indicating that they comply with the appropriate European EU directives. The ENEC certification process is currently underway for the Fortimo LED SLM Gen4/Gen4+ modules. The relevant standards are summarized below. To ensure luminaire approval, the conditions of acceptance need to be fulfilled. Details can be requested from your local sales representative. All luminaire manufacturers are advised to conform to the international (luminaire standards IEC 60598-1) and national standards of luminaire design.

IP rating, humidity and condensation

The Fortimo LED SLM modules are built-in modules relying on the luminaire for environmental protection. They have no IP classification. The Fortimo LED SLM has been developed and released for use in dry or damp locations. If there is a possibility that condensation could come into contact with the modules, the luminaire builder must take precautions to prevent this.

Electrostatic discharge (ESD)

ESD in production environment

Depending on the protection level of the LED module a minimum set of measures has to be taken when handling LED boards. Philips LED products have a high degree of ESD protection by design. ESD measures are required in a production environment where values can exceed the values shown in the ESD specifications table below.

ESD consultancy

Independent ESD consultancy companies can advise and supply adequate tools and protection guidance. Philips Innovation Services can provide consultancy www.innovationservices.philips.com. More information can be found in the section entitled 'Contact details'.

ESD specifications

Specifications of Fortimo LED SLM Gen4/Gen4+ are listed below:

Discharge	Model
<8 kV	Human Body Model (HBM) Class 3A JESD22-A114-E
<400 V	Machine Model (MM) Class B JESD22-A115-B

Environmental compliance

The photobiological safety standard IEC 62471 ('Photobiological safety of lamps and lamp systems') gives guidance on how to evaluate the photobiological safety of lamps and lamp systems including luminaires. This standard specifies the exposure limits, reference measurement technique and classification scheme for the evaluation and control of photobiological hazards from all electrically powered incoherent broadband sources of optical radiation including LEDs in the wavelength range from 200 nm through 3000 nm. Measured results of emission limits for Fortimo LED SLM Gen4/Gen4+ modules using the non-GLS (20 cm) method are listed in the following table:

Measured category	Fortimo LED SLM Gen4/Gen4+
Actinic UV	Exempt
Near UVA	Exempt
Retinal Blue Light	Risk group 1
Retinal Thermal	Exempt
IR Eye	Exempt
Thermal skin	Pass

Some facts on blue light

- All light; visible, IR and UV, causes fading
- It has long been known that blue light causes fading in yellow pigments
- LEDs do not produce more blue light than other sources by its nature

“Often, investigations into the effect of short-wavelength radiation—be it on humans or artwork—suggest that LEDs are dangerous because they emit more blue light than other sources like incandescent bulbs or CFLs. While it is true that most LED products that emit white light include a blue LED pump, the proportion of blue light in the spectrum is not significantly higher for LEDs than it is for any other light source at the same correlated color temperature (CCT).”

Blue Light Hazard

From the nature of most LEDs applying blue light, emphasis has been put on the hazard in terms of Photo Biological Safety (PBS). Evaluation by the European lighting industry (ELC, Celma) has concluded LED light sources are safe for customers when used as intended. A photobiological safety report is available at www.Philips.com/Technology. Nevertheless luminaire makers have to comply with luminaire standards including PBS. To avoid extensive retesting, it is preferred to build on the test conclusions of the LED (module) suppliers; however this should be discussed and agreed upon with the used certification body. The testing conclusion then will be expressed in Risk Groups (RG), where RG0 and RG1 are considered safe and/or do not require specific action for the luminaire makers (as compared to RG2 and 3).

CrispWhite Technology

Fortimo LED SLM Gen4/Gen4+ CrispWhite modules provide the user with intense whites and rich colors. Please note that the product has no UV wavelengths being emitted. A number of materials have been tested in combination with the crisp white light and the results are promising. When tested with PMMA, PC reflectors and silicone reflectors, under different temperature and light conditions, no photo-ageing effect from the deep blue flux is observed. If more information is needed, please contact your Philips representative.

Chemical Compatibility

The CoB contains a silicone overcoat to protect the LED chip and extract the maximum amount of light. As with most silicones used in LED optics, care must be taken to prevent any incompatible chemicals from directly or indirectly reacting with the silicone. The silicone overcoat used in the CoB is gas sensitive. Consequently, oxygen and volatile organic compound (VOC) gas molecules can diffuse into it. VOCs may originate from adhesives, solder fluxes, conformal coating materials, potting materials and even some of the inks that are used to print the PCBs. A list of commonly used chemicals, that should be avoided as they may react with the silicone material, is provided on the left. Note that Philips does not warrant that this list is exhaustive since it is impossible to determine all chemicals that may affect LED performance. These chemicals may not be directly used in the final products but some of them may be used in intermediate manufacturing steps (e.g. cleaning agents). Consequently, trace amounts of these chemicals may remain on (sub) components, such as heat sinks. It is recommended to take precautions when designing your application.

Chemical Name	Type
Hydrochloric acid	acid
Sulfuric acid	acid
Nitric acid	acid
Acetic acid	acid
Sodium Hydroxide	alkali
Potassium Hydroxide	alkali
Ammonia	alkali
MEK (Methyl Ethyl Ketone)	solvent
MIBK (Methyl Isobutyl Ketone)	solvent
Toluene	solvent
Xylene	solvent
Benzene	solvent
Gasoline	solvent
Mineral spirits	solvent
Dichloromethane	solvent
Tetrachlorometane	solvent
Castor oil	oil
Lard	oil
Linseed oil	oil
Petroleum	oil
Silicone oil	oil
Halogenated hydrocarbons (containing F, Cl, Br elements)	misc
Rosin flux	solder flux
Acrylic Tape	adhesive

Philips Fortimo LED SLM Gen4/Gen4+ modules comply with the European norms shown below.

Safety

IEC/ EN 62031	LED modules for general lighting - safety specifications
IEC/ EN 62471	Photobiological safety of lamps and lamp systems (included as part of the IEC 62031 approbation)

Philips Xitanium driver

IEC/ EN 61347 - 1	Lamp control gear
-------------------	-------------------

Electromagnetic compatibility

(tested with Fortimo LED SLM Gen4/Gen4+ modules and Philips Xitanium driver).

EN 55015, CISPR 55015	Limits and methods of measurement of radio disturbance characteristics of electrical lighting and similar equipment
IEC/ EN 61000-3-2	Limits for harmonic current emissions (equipment input current <16 A per phase)
IEC/ EN 61000-3-3	Disturbance in supply systems: voltage fluctuations and flicker
IEC/ EN 61547	Equipment for general lighting purposes - EMC immunity requirements

Environmental

The product is compliant with European Directive 2011/65/EC on Restriction of the Use of Certain Hazardous Substances in electrical and electronic equipment (RoHS2).

Cautions

During storage and transportation

- Store in a dark place. Do not expose to sunlight.
- Maintain temperature between -40 ~ +80 °C, and RH 5 – 85%.

During operation

Philips shall not be held responsible or liable for any damage, costs or expenses to the user, resulting from an accident or any other cause during operation if the system is used without due observance of the absolute maximum ratings and other instructions provided by Philips.

Note:

That warranty is applicable for the Philips Fortimo LED SLM modules for 1 switching cycle per day in combination with a SELV driver.

Contact details

Philips

www.Philips.com/Technology

Or contact your local Philips sales representative

Philips ESD support

www.innovationservices.philips.com

Phone : +31- (0) 40 27 46658

Fax : +31 - (0) 40 27 42224

The Philips corporate EMC competence centre is a leading provider of approbation and consultancy services.

Disclaimer

Philips will perform the testing of the LED systems to high standards of workmanship. The tests are carried out with reference to the EN/IEC standards, if any, which are regarded by Philips as being of major importance for the application of the lamp gear and the lamp within the fixture for horticultural applications.

The design-in guide, regarding the testing and design in of the LED system provided by Philips, is not an official testing certificate, and cannot be regarded as a document for official release of the fixture. The OEM is liable for the official testing by a certified test body and all markings, such as CE and ENEC marks, on the fixture assembly.

The design-in guide is for information purposes only and may contain recommendations for detecting weak points in the design of the system (lamp – lamp gear – fixture), if any.

Specifically mentioned materials and/or tools from third parties are only indicative: other equivalent equipment may be used but it is recommended that you contact Philips for verification.

Philips will not be liable for unforeseen interactions of the proposed solutions when applied in the fixtures or applications using these fixtures. Philips has not investigated whether the recommendations are or will in the future be in conflict with existing patents or any other intellectual property right. Philips does not warrant that its recommendations are technically or commercially the best options.

Since the tests are only performed on one particular fixture provided by the customer, it will be treated as a prototype. This means that there is no statistical evidence regarding later production quality and performance of the lamp – lamp gear – fixture system.

As Philips does not have control over manufacturing of the fixtures, Philips cannot be held liable for the fixture assembly.

Philips will not accept claims for any damage caused by implementing the recommendations.

No warranty whatsoever may be claimed by the OEM with regard to the content and/or quality of the design-in guide or any other advice, or the conclusions and/or recommendations in the design-in guide or any other document, either express or implied, and Philips expressly disclaims any implied warranties of any kind, including without limitation any warranties of satisfactory quality, fitness for a particular purpose or non-infringement and any warranties regarding the design-in guide or any other advice or the use of the results of any activity performed while testing the fixture with respect to its correctness, quality, accuracy, completeness, reliability, performance or otherwise.

The OEM expressly agrees that test design-in guides are provided by Philips on an 'as is' basis and an 'as available' basis at customer's sole risk and expense. Philips shall not be liable for any lost profits or lost savings, indirect, incidental, punitive, special, or consequential damages whether or not such damages are based on tort, warranty, contract, or any other legal theory – even if Philips has been advised, or is aware, of the possibility of such damages.

The OEM must bring any claim for damages within ninety (90) days of the day of the event giving rise to any such claim, and all lawsuits relative to any such claim.

