

**PHILIPS**

Fortimo

LED system

FastFlex Gen3



Outstanding performance while enabling  
OEM optical differentiation

# Flexible LED system approach

Outdoor LED lighting



“

**Outstanding performance**  
while enabling OEM  
optical differentiation in  
road, urban and industrial  
lighting applications.”

## What's new?

- Enables OEM optical differentiation with lenses from standard FastFlex and third party portfolios matching every project's needs
- Unparalleled lumen per watt for outstanding fixture performance
- Designed for fixture optimization in terms of module temperature and drive current setting Vs lifetime and lumen depreciation target



### Fortimo FastFlex boards:



2x8 DS Gen3

2x8 DA Gen3

2x8 Gen3

2x4 Gen3

# Fortimo **FastFlex LED Gen3**

The Fortimo FastFlex LED Gen3 proposition consists of two main product groups.

First, the standard Fortimo FastFlex Gen3 (2x8 and 2x4 forms factors), which is a LED lighting system containing two key building blocks - a LED board and a FastFlex lens, suitable for operation on Xitanium LED outdoor programmable drivers.

Secondly, the Fortimo FastFlex Differentiation Family Gen3, consisting of a Differentiation Array (DA) version and a Differentiation Single (DS) version. These LED boards are developed to operate with third party lenses and are suitable for operation on Xitanium LED outdoor programmable drivers.



## Features

- State of the art specifications
- Temperature and drive current designed for fixture optimisation
- Optical flexibility via standard FastFlex or third party lenses
- Flexible lumen output
- Range of CCT and CRI versions (see table)

## Applications

- Road lighting
- Urban street lighting
- Flood and Area lighting
- Tunnel lighting
- High bay lighting



# Outstanding performance and versatility

## **Optical differentiation for Every project's needs**

The Fortimo FastFlex LED system Gen3 portfolio has been designed to offer a suitable solution to OEMs who want to distinguish themselves through their fixture design and speed to market, as well as OEMs wanting to differentiate their propositions based on optical (photometric) performance. As a result the standard Fortimo FastFlex Gen3 2x8 and 2x4 are designed for OEMs looking for a “one stop shop”, where board and lens are provided by Philips, allowing a short fixture development cycle, while enabling good optical flexibility with its eight standard light distributions. For OEMs looking to have a unique photometric performance, the new Fortimo FastFlex Differentiation Family (DA and DS Gen3) are designed to operate together with third party lenses, enabling an unlimited number of possible optical configurations, allowing the use of standard components for a unique photometric result.

## **Unparalleled lumen per watt for outstanding fixture performance**

The Fortimo FastFlex LED board Gen3 offers best in class energy efficiency, with performance efficacy of up to 160 lm/W. The remarkable energy savings and CO<sub>2</sub> reductions achieved with a Fortimo FastFlex LED Gen3 system can be further extended with dimming. By lowering the light levels during off peak hours, energy usage is reduced and light pollution is minimized, improving quality of life for local residents.

## **Designed for fixture optimization in terms of temperature and drive current settings**

The Fortimo FastFlex LED module Gen3 features the most comprehensive set of LED module performance information, allowing the OEM to optimize his fixture design to the target specifications.

As part of the mentioned set of performance information, the Fortimo FastFlex module Gen3 provides a series of charts displaying the relation between the temperature case and module driving current, to expected lifetime (up to 100,000 hours) and lumen depreciation values (L70 and above); enabling the best fixture performance to cost ratio.

# Product specifications Fortimo FastFlex LED modules Gen3

## Product specifications at 530 mA (Reference current)

Commercial Name	Module power	Module efficacy typical	Light output	Correlated color temperature	Color rendering index	Tcase	Thermal load	Max input voltage	Color consistency	Lifetime 90% survivals	Order code
	(W)	(lm/W)	(lm)	(K)	(min. CRI)	(°C)	(W)	(V)	(SDCM)	(Khrs)	(EOC)
Fortimo FastFlex LED board 2x8/730 G3	24	137	3245	3000	>70	75	14.6	50	4	>55*	8718696 454299 00
Fortimo FastFlex LED board 2x8/740 G3	24	148	3505	4000	>70	75	14	50	4	>55*	8718696 454312 00
Fortimo FastFlex LED board 2x8/757 G3	24	151	3575	5700	>70	75	14	50	4	>55*	8718696 454336 00
Fortimo FastFlex LED board 2x8/840 G3	24	137	3245	4000	>80	75	14.6	50	4	>55*	8718696 454350 00
Fortimo FastFlex LED board 2x4/740 G3	12	148	1753	4000	>70	75	7	25	4	>55*	8718696 454558 00
Fortimo FastFlex LED board 2x4/730 G3	12	137	1623	3000	>70	75	7.3	25	4	>55*	8718696 454534 00
Fortimo FastFlex LED board 2x8/730 DA G3	24	137	3245	3000	>70	75	14.6	50	4	>55*	8718696 454459 00
Fortimo FastFlex LED board 2x8/740 DA G3	24	148	3505	4000	>70	75	14	50	4	>55*	8718696 454473 00
Fortimo FastFlex LED board 2x8/757 DA G3	24	151	3575	5700	>70	75	14	50	4	>55*	8718696 454497 00
Fortimo FastFlex LED board 2x8/730 DS G3	24	137	3245	3000	>70	75	14.6	50	4	>55*	8718696 454398 00
Fortimo FastFlex LED board 2x8/740 DS G3	24	148	3505	4000	>70	75	14	50	4	>55*	8718696 454411 00
Fortimo FastFlex LED board 2x8/757 DS G3	24	151	3575	5700	>70	75	14	50	4	>55*	8718696 454435 00

\* Charts presenting module's Tc and current versus expected lifetime (up to 100,000 hours), as well as module's Tc and current versus expected lumen depreciation (L70 and above) are available via your Philips sales representative.

## FastFlex LED modules 2x8/740 performance at different drive currents

Driver current (mA)	Light output (lm)	Efficacy (lm/W)	Thermal power (W)	Electrical power (W)	Max electrical power (W)
350	2430	158	8.6	15.4	17.2
530	3505	148	14	23.8	26.5
700	4450	139	19.5	32	35.6
1000	6000	128	30	46.9	52

## FastFlex LED modules 2x8/730 performance at different drive currents

Driver current (mA)	Light output (lm)	Efficacy (lm/W)	Thermal power (W)	Electrical power (W)	Max electrical power (W)
350	2250	146	9	15.4	17.2
530	3245	137	14.6	23.8	26.5
700	4115	129	20.2	32	35.6
1000	5540	118	31	46.9	52

## FastFlex LED modules 2x8/757 performance at different drive currents

Driver current (mA)	Light output (lm)	Efficacy (lm/W)	Thermal power (W)	Electrical power (W)	Max electrical power (W)
350	2475	160	8.6	15.4	17.2
530	3575	151	14	23.8	26.5
700	4535	142	19.5	32	35.6
1000	6100	130	30	46.9	52

## FastFlex LED modules 2x4/740 performance at different drive currents

Driver current (mA)	Light output (lm)	Efficacy (lm/W)	Thermal power (W)	Electrical power (W)	Max electrical power (W)
350	1215	158	4.3	7.7	8.6
530	1753	148	7	11.9	13.2
700	2225	139	10	16	17.8
1000	3000	128	15	23.4	25.6

## FastFlex LED modules 2x4/730 performance at different drive currents

Driver current (mA)	Light output (lm)	Efficacy (lm/W)	Thermal power (W)	Electrical power (W)	Max electrical power (W)
350	1125	146	4.5	7.7	8.6
530	1623	137	7.3	11.9	13.2
700	2058	129	10.2	16	17.8
1000	2770	118	15.5	23.4	25.6

### Recommended Xitanium LED drivers

For all possible module-driver combinations see each datasheet of the specific LED board or visit our website [www.philips.com/fastflex](http://www.philips.com/fastflex)

For Xitanium LED driver specifications, please visit [www.philips.com/xitanium](http://www.philips.com/xitanium)

- Light-output is specified at board level, FastFlex lenses optical losses are specified at 4%
- FastFlex LED module has a 5 year system warranty in combination with approved Xitanium LED drivers
- For a full specification overview of your selected Fortimo FastFlex LED Gen3, please check the product datasheet

**Note:** Philips maintains a tolerance of  $\pm 7\%$  on luminous flux,  $\pm 2\%$  on CRI measurements and  $\pm 5\%$  on CCT measurements.

# Photometric performance of FastFlex Lenses Gen2 applicable for standard Fortimo FastFlex 2x8 and 2x4 Gen3

• Isolux diagram • Polar intensity diagram • Application rendering



## Fortimo FastFlex lens 2x8/II-X Gen2

Designed for narrow roads and urban street lighting.

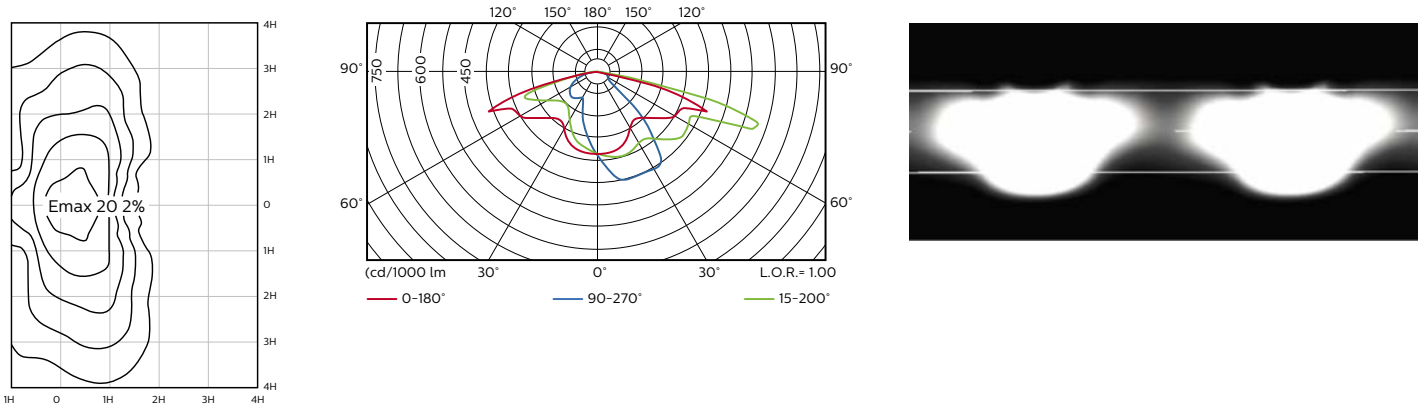

## Fortimo FastFlex lens 2x8/III-X Gen2

Designed for roads of medium width and urban street lighting.

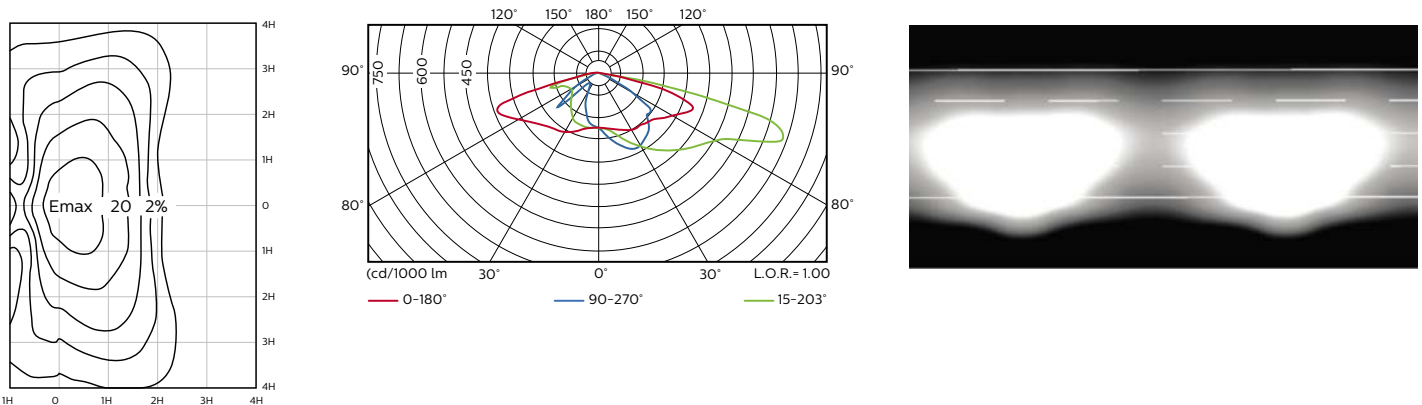

## Fortimo FastFlex lens 2x8/IV-X Gen2

Designed for wide roads and asymmetrical floodlighting.

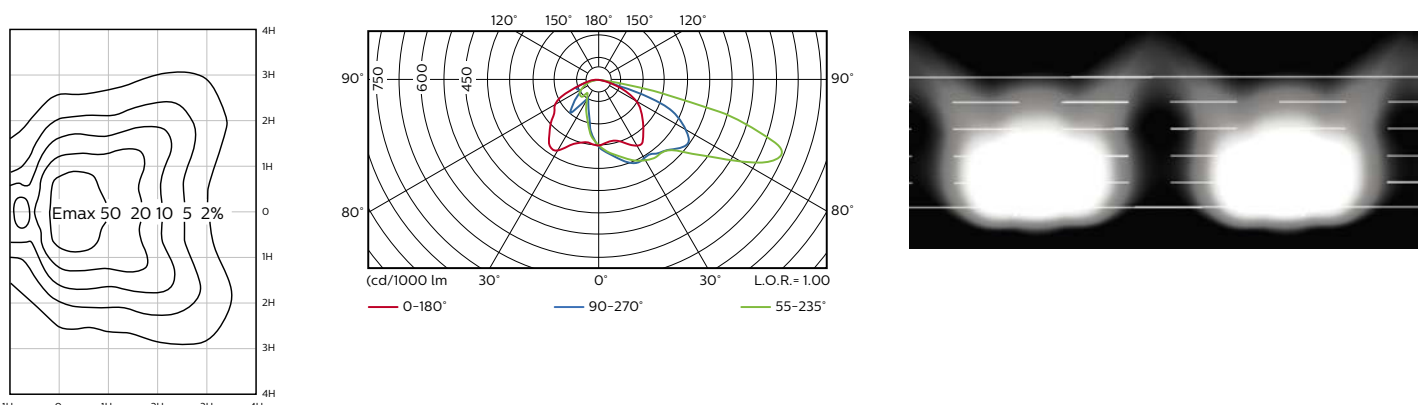



### Fortimo FastFlex lens 2x8/V Gen2

Designed for symmetrical lighting, e.g. high bays, parking lots, petrol stations.

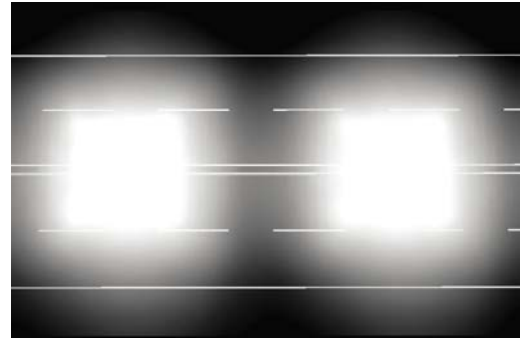
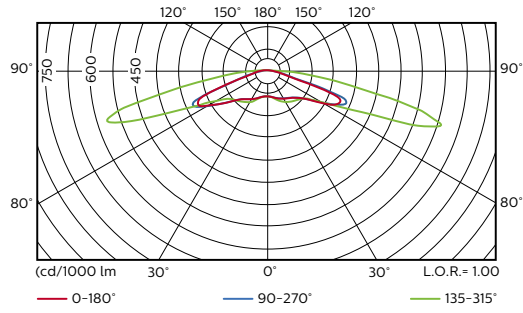
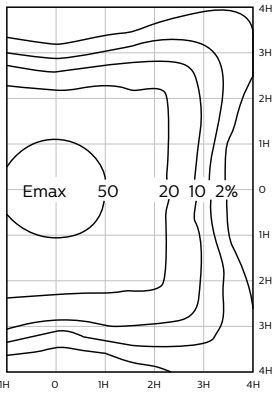

### Fortimo FastFlex lens 2x8/HB65 Gen2

Designed for high bay lighting.

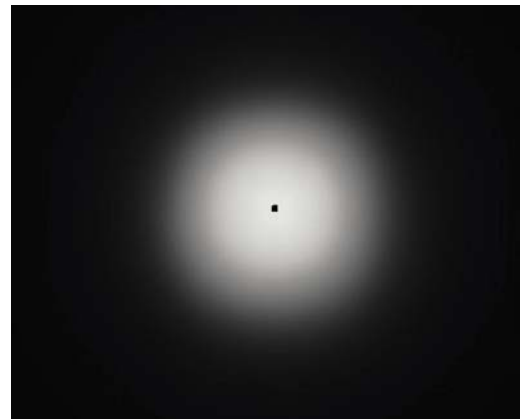
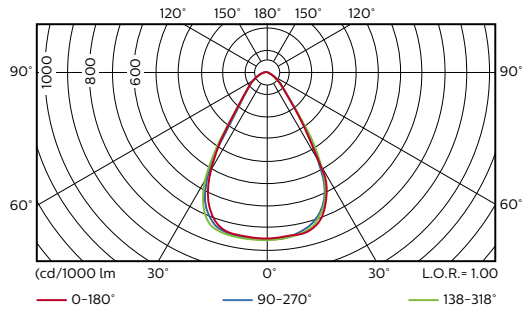
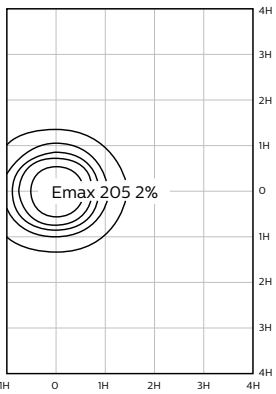

### Fortimo FastFlex lens 2x8/II-x WTR Gen2

Designed for wet road lighting.

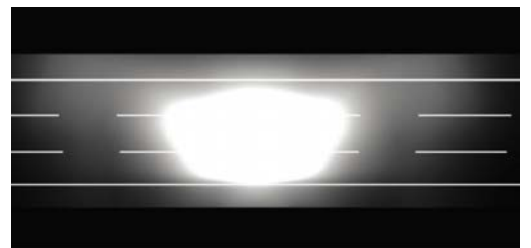
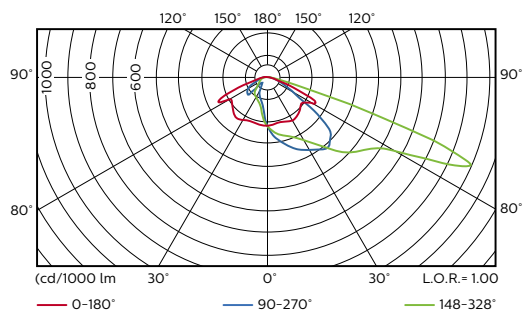
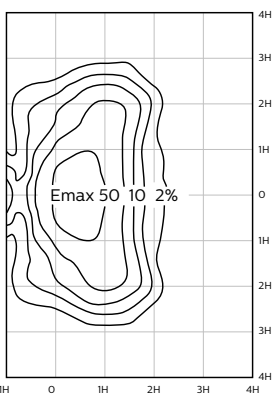

## Fortimo FastFlex lens 2x4/SW-X Gen2

Designed for Pedestrian Road and Bicycle path lighting.

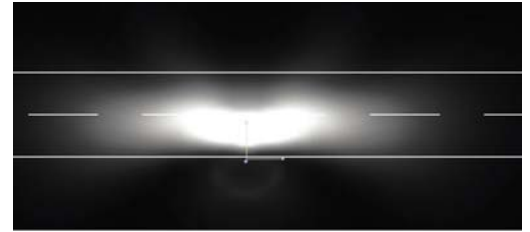
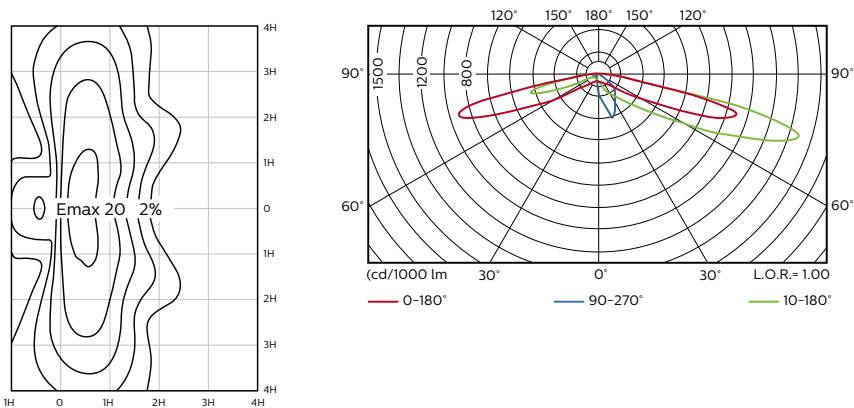

## Fortimo FastFlex lens 2x4/V\_C Gen2

Designed for Park lighting and Squares within towns and cities.

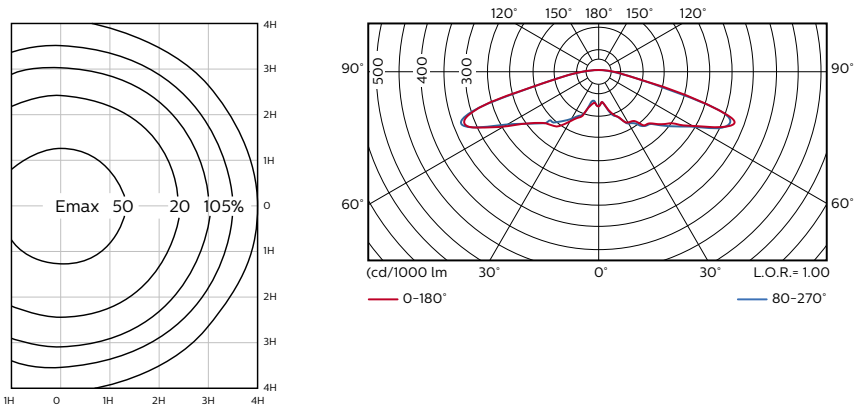

## Fortimo FastFlex lensless mounting Gen 2

Designed to enable the use of the Fortimo FastFlex Gen3 board without lenses.

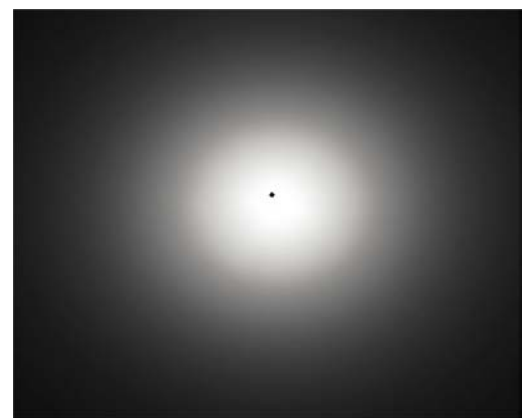
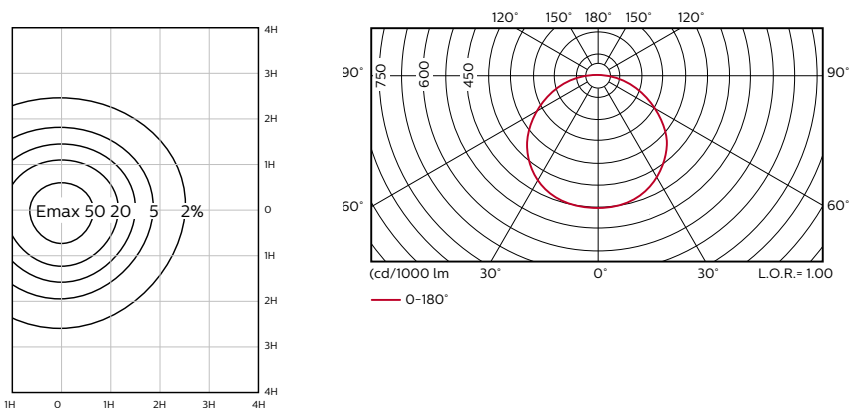

Fortimo FastFlex DA and DS Gen3 version operate with third party lenses. (OEM or complementary partner optics).

Please contact your Phillips sales representative for more information on compatible lenses.





© 2015 Royal Philips N.V. All rights reserved. Philips reserves the right to make changes in specifications and/or to discontinue any product at any time without notice or obligation and will not be liable for any consequences resulting from the use of this publication.

[www.philips.com/fortimo](http://www.philips.com/fortimo)  
[www.philips.com/xitanium](http://www.philips.com/xitanium)

02/2015  
Data subject to change.