

**PHILIPS**

Fortimo

LED system

Strip Gen3 2 ft  
2200 lm 1R HV3



## Datasheet

# Fortimo LED Strip Gen3

Fortimo LED Strip systems are ideal for use in designer or miniaturized, slim linear luminaires for architectural applications, which were not previously possible with fluorescent lighting or Fortimo LED Line.

### Key features and benefits

- State-of-the-art LED module efficiency of up to 165 lm/W
- Long life-time: >50,000 hours
- High color rendering (CRI >80 and >90)
- Excellent color consistency of 3 SDCM
- Variety of color temperatures (3000 K, 4000 K and 5000 K)
- Two lumen packages: 650 lm and 1100 lm per foot
- Tunable lumen output, efficacy and lifetime
- Wide case temperature (Tc) range from -40 °C to +80 °C
- Push-in connectors enabling automated wiring
- Five year system warranty

### Suitable for:

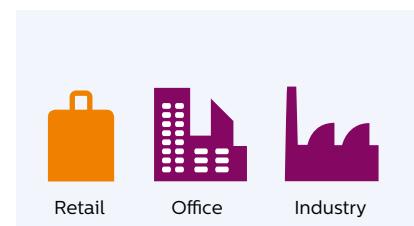

## Ordering data

---

Commercial product name	EOC	12NC
Fortimo LED Strip 2ft 2200lm 830 1R HV3	8718696 413975 00	92900 0924 306
Fortimo LED Strip 2ft 2200lm 840 1R HV3	8718696 414019 00	92900 0924 506
Fortimo LED Strip 2ft 2200lm 850 1R HV3	8718696 414033 00	92900 0924 606

## Generic currents and case temperature

---

Parameter	Nominal *	Life**	Max***	Unit
Tc (case temperature at Tc point)	45	65	80	°C
I (current through the LED module)	300	390	450	mA

\* Nominal value at which typical performance is specified.

\*\* Value at which lifetime is specified.

\*\*\* Maximum value for safe operations; do not operate above this value.

## Optical characteristics - table per CCT

### Fortimo LED Strip 2 ft 2200 lm 830 1R HV3

Parameter	Min	Typ	Max	Unit
Correlated color temperature (CCT) target		3000		K
Correlated color temperature (CCT) measured		3060		K
Color coordinates (CIEx, CIEy)		(0.4318, 0.4010)		-
CRI	80			-
Radiation angle		120		deg

Color consistency of 3 SDCM, averaged over the module.

Operation point	830	lm	lm/W
80% I-nom 240 mA	Tc 25 °C	1783	164
	Tc-nom 45 °C	1739	161
	Tc-life 65 °C	1692	158
I-nom 300 mA	Tc 25 °C	2173	157
	Tc-nom 45 °C	<b>2120</b>	<b>155</b>
	Tc-life 65 °C	2063	152
I-life 390 mA	Tc 25 °C	2726	149
	Tc-nom 45 °C	2658	147
	Tc-life 65 °C	2587	144

Tolerance for flux data is ±7.5%.

Tolerance for efficacy data is ±10%.

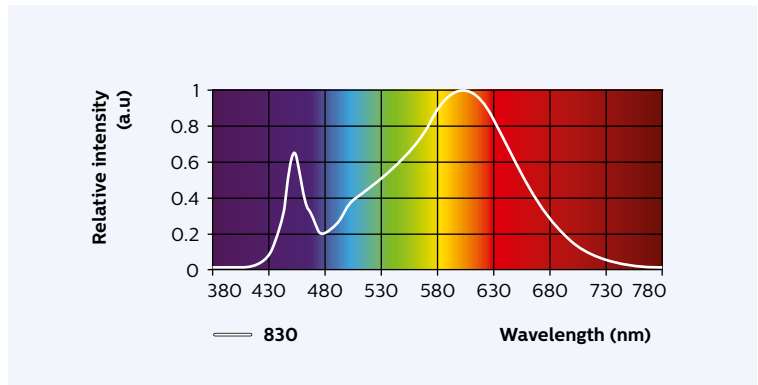

### Fortimo LED Strip 2 ft 2200 lm 840 1R HV3

Parameter	Min	Typ	Max	Unit
Correlated color temperature (CCT) target		4000		K
Correlated color temperature (CCT) measured		4005		K
Color coordinates (CIEx, CIEy)		(0.3804, 0.3773)		-
CRI	80			-
Radiation angle		120		deg

Color consistency of 3 SDCM, averaged over the module.

Operation point	840	lm	lm/W
80% I-nom 240 mA	Tc 25 °C	1851	169
	Tc-nom 45 °C	1805	166
	Tc-life 65 °C	1756	164
I-nom 300 mA	Tc 25 °C	2255	162
	Tc-nom 45 °C	<b>2200</b>	<b>160</b>
	Tc-life 65 °C	2141	157
I-life 390 mA	Tc 25 °C	2828	153
	Tc-nom 45 °C	2759	151
	Tc-life 65 °C	2684	149

Tolerance for flux data is ±7.5%.

Tolerance for efficacy data is ±10%.

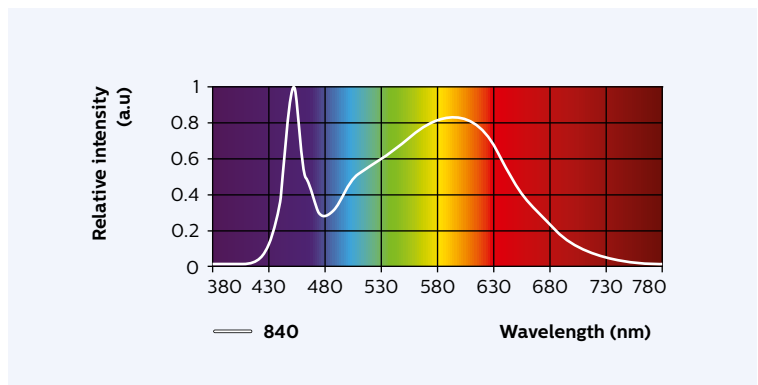

## Fortimo LED Strip 2 ft 2200 lm 850 1R HV3

Parameter	Min	Typ	Max	Unit
Correlated color temperature (CCT) target		5000		K
Correlated color temperature (CCT) measured		5100		K
Color coordinates (CIEx, CIEy)		(0.3425, 0.3518)		-
CRI	80			-
Radiation angle		120		deg

Color consistency of 3 SDCM, averaged over the module.

Operation point	850	lm	lm/W
80% I-nom 240 mA	Tc 25 °C	1884	172
	Tc-nom 45 °C	1838	170
	Tc-life 65 °C	1788	167
I-nom 300 mA	Tc 25 °C	2297	165
	Tc-nom 45 °C	<b>2240</b>	<b>163</b>
	Tc-life 65 °C	2179	160
I-life 390 mA	Tc 25 °C	2880	156
	Tc-nom 45 °C	2809	154
	Tc-life 65 °C	2733	152

Tolerance for flux data is ±7.5%.

Tolerance for efficacy data is ±10%.

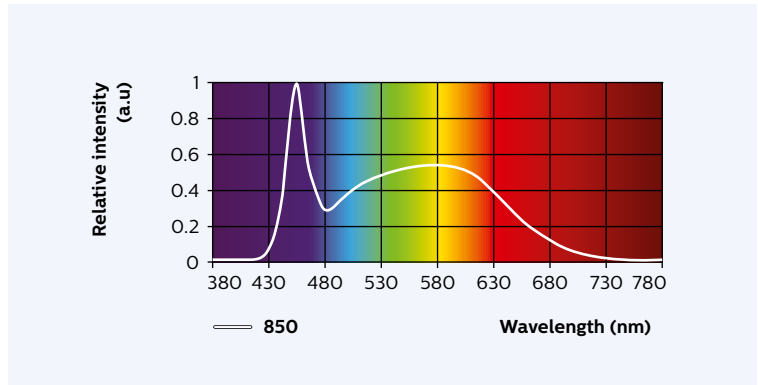

## Beam shape

The Philips Fortimo LED module generates a Lambertian beam shape, which is a pragmatic starting point for OEMs wishing to design secondary optics.

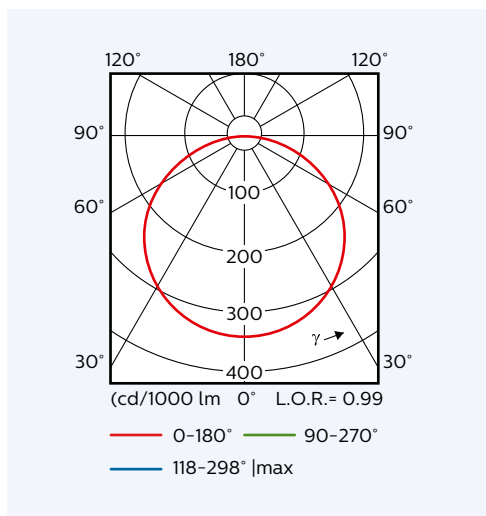

## Electrical characteristics

Parameter	Min	Typ	Max	Unit
Nominal current		300		mA
Forward voltage	43.5	45.6	47.0	V
Power consumption	13.0	13.7	14.1	W
Energy efficiency label		A++		
Minimum dimming for performance	10			%
Number of parallel modules per chain			N/A	

Note: Specifications stated at Tc nom = 45 °C and I nom = 300 mA.

## Lifetime

Operation point	Lifetime x 1000 hours	L70			L80			L90		
		B50	B20	B10	B50	B20	B10	B50	B20	B10
80% I-nom 240 mA	Tc 25 °C	>50	-	>50	>50	-	-	-	-	-
	Tc-nom 45 °C	>50	-	>50	>50	-	-	-	-	-
	Tc-life 65 °C	>50	-	>50	>50	-	-	-	-	-
I-nom 300 mA	Tc 25 °C	>50	-	>50	>50	-	-	-	-	-
	Tc-nom 45 °C	>50	-	>50	>50	-	-	-	-	-
	Tc-life 65 °C	>50	-	>50	>50	-	-	-	-	-
I-life 390 mA	Tc 25 °C	>50	-	>50	>50	-	-	-	-	-
	Tc-nom 45 °C	>50	-	>50	>50	-	-	28	-	-
	Tc-life 65 °C	>50	-	>50	40	-	34	19	-	16

Additional data will be added once the required measurement time has elapsed

Parameter	Min	Typ	Max	Unit
$\Delta u'v'$ at 6000 hours			0.007	-

Note: Specifications stated while Tc < 65 °C and I < 390 mA.

## Abs max ratings

Parameter	Min	Typ	Max	Unit
Current Imax			450	mA
Case temperature Tc max			80	°C
ESD (direct contact)			8	kV
ESD (air)			15	kV
Isolation breakdown voltage	2250			Vdc
Ambient temperature	-40			°C

## Wiring

Specification item	Value	Unit	Condition
Input wire cross-section	0.2...0.8	mm <sup>2</sup>	Solid and fine stranded
	18...24	AWG	
Input wire strip length	7.5...8.5	mm	

Note: connector suited for robot wiring.

## Mechanical characteristics

Parameter	Min	Typ	Max	Unit
Length	558.9	559.2	559.5	mm
Width	19.8	20	20.6	mm
Height excl. connector	1.45	1.60	1.75	mm
Height incl. connector	3.85	4.2	4.55	mm
Warpage (IPC-TM-650)			4.2	mm

Note: Bow & Twist of the PCB after production tested and released according IPC-TM-650 2.4.22.

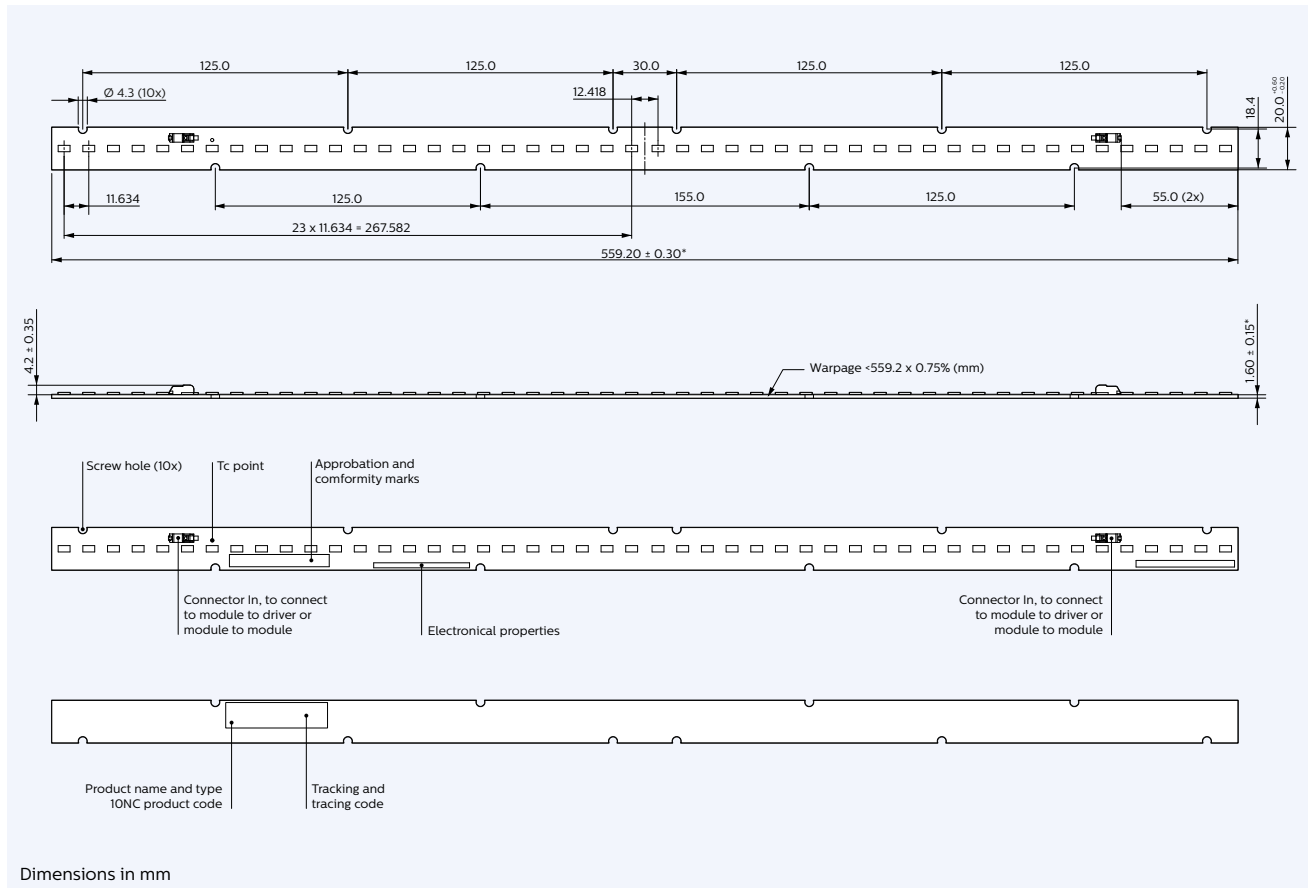

Dimensions in mm

## Application information

---

### Compliance and approval

IEC / EN 62031, IEC / EN 62471, IEC / TR 62778.

### Environmental

RoHS / REACH.

## Application information

### Zhaga

Designation of the ECG housing (book-1 / annex C)	BL3
Designation of the Book-7 LLE category	L56W2
Luminous Flux category	C020
CCT category	4000 K
CRI	80
A plain-text-file with a format as defined in Book-7, section 4.5	<a href="http://www.philips.com/technology/">www.philips.com/technology/</a>
A greyscale image with a format as defined in Book-7, section 4.5	
The position of the temperature measurement point tp	same as Tc point
The value of tp,max	65
The value of tp,headroom	-

### IP rating

Overheating protection	No protection
Luminaire class	IEC Class I

### No IP rating

Warranted number of full thermal product cycles @ 25 °C ambient temperature.

Case temperature Tc [°C]	Amount of cycles
35	
40	
45	>30,000
50	
55	25,000
60	
65	12,500
70	
75	<5,000
80	4,166
85	
90	
95	

## Tuning information

### Flux and efficacy versus current

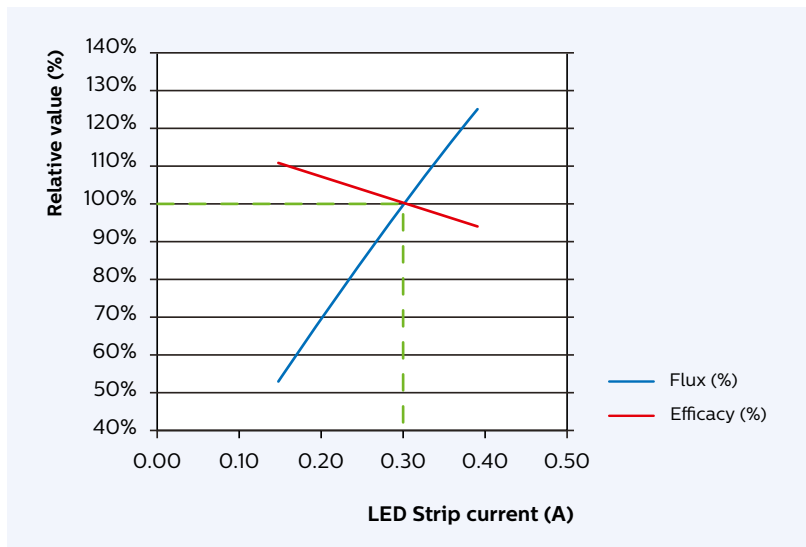

I [A]	Flux [%]	Efficacy [%]
0.390	125%	94%
0.375	121%	95%
0.350	114%	97%
0.325	107%	98%
0.300	100%	100%
0.275	93%	102%
0.250	85%	103%
0.225	77%	105%
0.200	70%	107%
0.175	62%	109%
0.150	53%	111%

### Flux and efficacy versus temperature at Tc

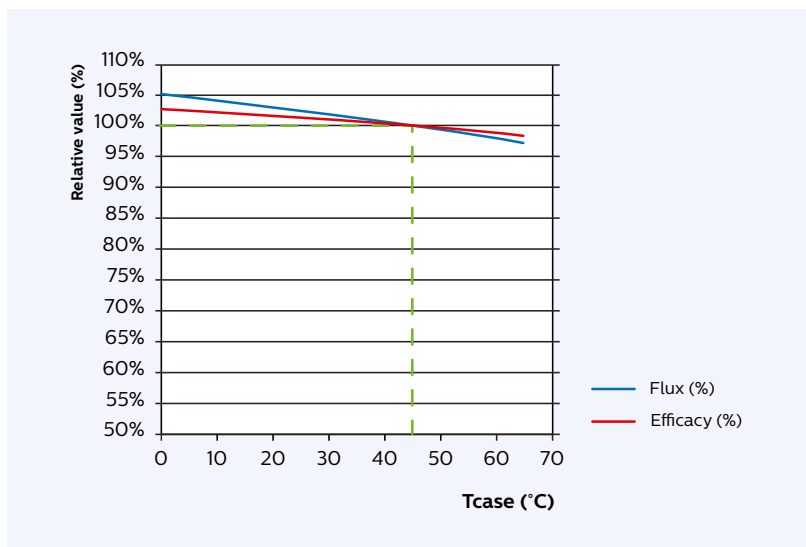

Tc [°C]	Flux [%]	Efficacy [%]
65	97%	98%
60	98%	99%
55	99%	99%
50	99%	100%
45	100%	100%
40	101%	100%
35	101%	101%
30	102%	101%
25	103%	101%
20	103%	102%
15	104%	102%
10	104%	102%
5	105%	103%
0	105%	103%



## Lumen maintenance

### Lumen maintenance at I life and Tc life conditions

Fortimo LED Strip 2 ft 2200 lm 1R HV3

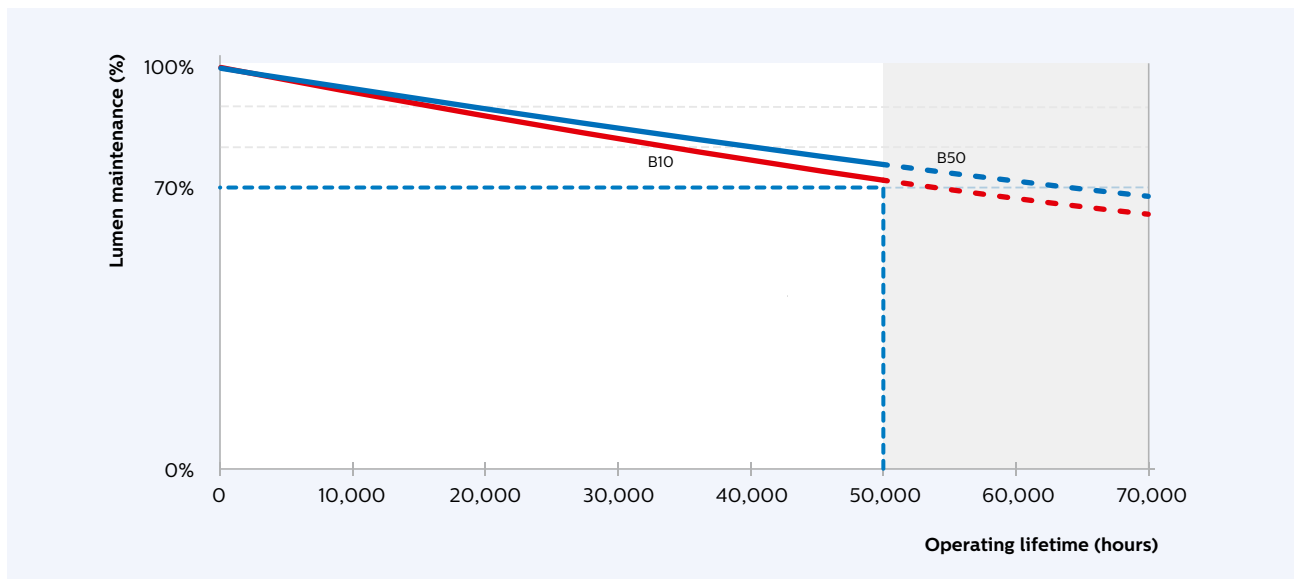

Lumen depreciation as a function of operating hours for I-life and Tc-life. 36,000 hours proven by certified laboratory.

### Lumen maintenance (B50) at current I life

Fortimo LED Strip 2 ft 2200 lm 1R HV3

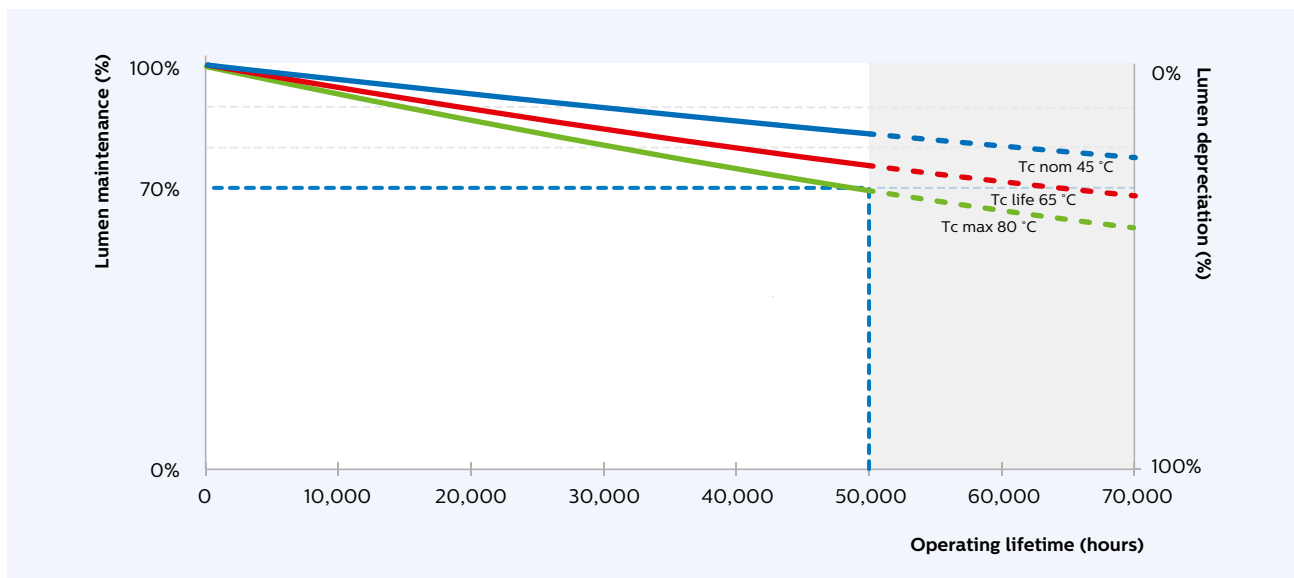

Lumen depreciation as a function of operating hours at different Tc values and I-life. 36,000 hours proven by certified laboratory.

# Wiring schematic

## Examples

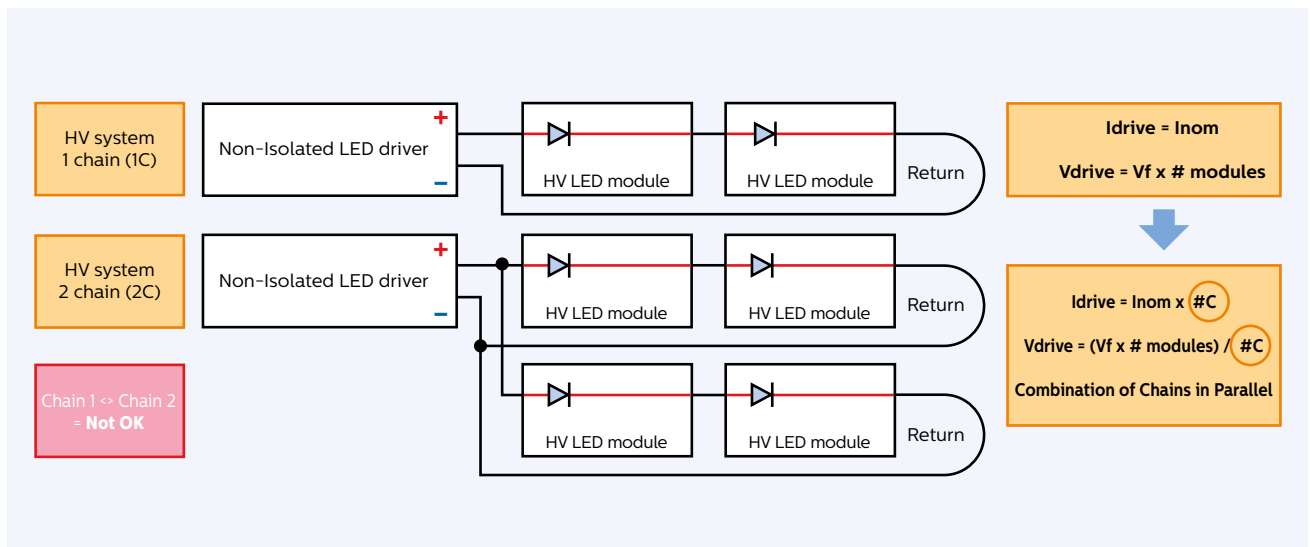



© 2014 Royal Philips N.V. All rights reserved. Philips reserves the right to make changes in specifications and/or to discontinue any product at any time without notice or obligation and will not be liable for any consequences resulting from the use of this publication.

[www.philips.com/technology](http://www.philips.com/technology)  
[www.philips.com/fortimo](http://www.philips.com/fortimo)  
[www.philips.com/xitanium](http://www.philips.com/xitanium)