

PHILIPS

Xitanium

LED driver



Datasheet

Xitanium FULL Prog LED Xtreme drivers

Xi FP 35W 0.3-1.0A NLD C150 230V sXt

Xitanium FULL Prog LED Xtreme drivers

Philips Xitanium Full Programmable LED drivers are specifically designed to deliver the highest performance, protection and configurability. The portfolio offers both central and standalone dimming protocols further increasing the energy savings and CO₂ reductions achieved with LED lighting. The Xtreme technology ensures maximum robustness and protection combined with a very long lifetime.

In this product family Philips introduces new drivers in a compact form factor with state-of-the-art features, which offer high value for both OEM customers and end-users. The products can replace the existing programmable outdoor LED drivers and will bring significant improvement in programming, assembly into a luminaire and electrical performance.

Benefits

- Ultimate robustness, offering peace of mind and lower maintenance costs
- Fully programmable LED-drivers designed for the new digital and connected lighting world
- Extended diagnostics via MultiOne
- Easy to design-in, configure and install for Class I and Class II applications
- Energy savings through high efficiency and via multiple dimming options

Features

- High surge protection (CM/DM)
- Long lifetime and robust protection against moisture, vibration and temperature
- Configurable operating windows (AOC)
- Multiple control interfaces: DALI, LineSwitch
- Autonomous dimming via integrated DynaDimmer
- Thermal protection for driver and for module (MTP)
- Constant Light Output (CLO)
- Adjustable Start-up Time (AST)
- Adjustable Light Output (ALO)
- End-Of-Life indicator (EOL)

Application

- Road and street lighting
- Area lighting
- Industrial lighting

Electrical input data

Specification item	Value	Unit	Condition
Nominal input voltage	220...240	V _{ac}	performance range
Nominal input frequency	50...60	Hz	
Nominal input current	0.2	A	@230V @ full load
Max. input current	0.22	A	@ minimum input voltage AC
Input voltage	230	V _{ac}	
Nominal input power	42	W	@230V @ full load
Power factor	>= 0.96		@ full load. See graph.
Total harmonic distortion	<= 14	%	@ full load. See graph.
Efficiency	84	%	@230V @ full load
Input voltage AC	198...264	V _{ac}	Operational range
Input frequency AC	45...66	Hz	Maximum permissible range
Standby power	0.8	W	

Electrical output data

Specification item	Value	Unit	Condition
Regulation method	Constant Current		
Output voltage	20...60	V _{dc}	
Output voltage max.	80	V	Peak voltage at open load
Output current	0.07...1	A	Full output current setting
Output current min programmable	100	mA	
Output current min dimming	70	mA	
Output current tolerance	± 5	%	
Output current ripple LF	<= 5	%	Ripple = peak / average
Output current ripple HF	<= 20	%	
Output power	4...36	W	Full output

Electrical data controls input

Specification item	Value	Unit	Condition
Control method	DALI-LineSwitch-Integrated Dynadim		DALI acc. IEC62386-101, -102 Ed. 2.0
Dimming range	7...100	%	Default range

Logistical data

Specification item	Value
Product name	Xi FP 35W 0.3-1.0A NLD C150 230V sXt
Order code	871869652101400
Logistic code 12NC	9290 009 91306
EAN3	8718696521021
Pieces per box	12

Wiring & Connections

Specification item	Value	Unit	Condition
Input wire cross-section	0.5...2.5	mm ²	WAGO804, solid wire
	12...20	AWG	WAGO804, solid wire
Input wire strip length	10...11	mm	
Output wire cross-section	0.3...1.5	mm ²	WAGO805, solid / stranded wire
	16...24	AWG	WAGO805, solid / stranded wire
Output wire strip length	9...10	mm	
Maximum cable length	20000	mm	Total length of wiring including LED module, one way

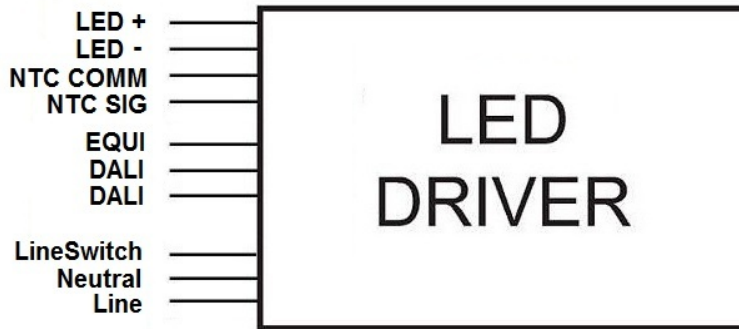

Insulation

Insulation	Mains	LineSwitch	EQUI	DALI	LED + NTC
Mains		No	Double	Basic	SELV
LineSwitch	No		Double	Basic	SELV
EQUI	Double	Double		Double	Double
DALI	Basic	Basic	Double		Double
LED + NTC	SELV	SELV	Double	Double	

Dimensions and weight

Specification item	Value	Unit	Condition
Length (A1)	150	mm	
Width (B1)	90	mm	
Height (C1)	40	mm	
Fixing hole diameter (D1)	4.5	mm	
Fixing hole distance (A2)	133.6	mm	
Weight	770	gram	

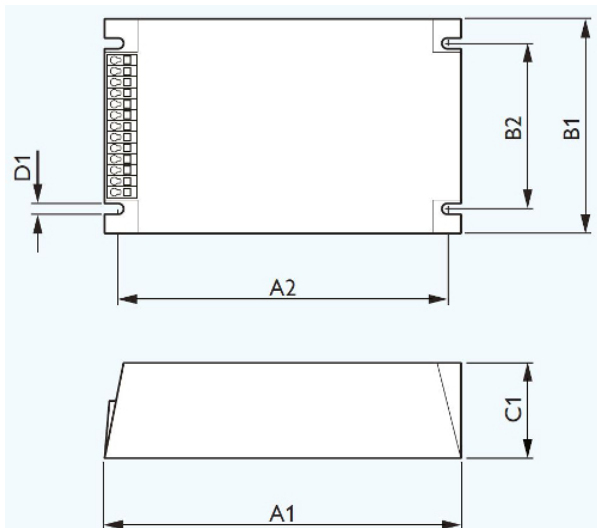

Operational temperatures and humidity

Specification item	Value	Unit	Condition
Ambient temperature	-30...+60	°C	Higher ambient temperature allowed as long as T _{case-max} is not exceeded.
Starting Ambient temperature	-40...+60	°C	
T _{case-max}	90	°C	Maximum temperature measured at T _c -point
T _{case-life}	75	°C	Measured at T _c -point
Maximum housing temperature	130	°C	In case of a failure
Relative humidity	10...90	%	Non-condensing

Storage temperature and humidity

Specification item	Value	Unit	Condition
Ambient temperature	-30...+80	°C	
Relative humidity	10...90	%	Non-condensing

Lifetime

Specification item	Value	Unit	Condition
Driver lifetime	100,000	hours	Measured temperature at T _c -point is T _{case-life} . Maximum failures = 10%

Lifetime versus T_{case}

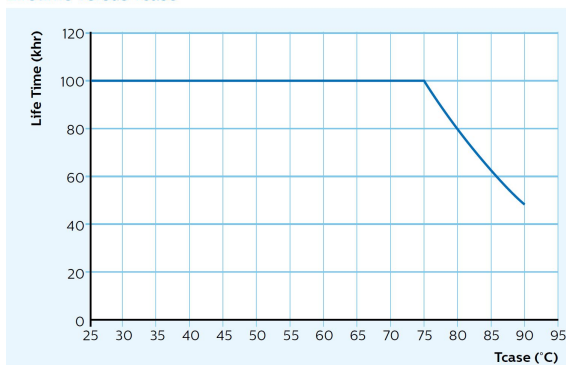

Programmable features

Specification item	Value	Remark	Condition
Set output current (AOC)	Programmable	See Design-in guide.	Default output current: ≤ 700 mA
LED module temperature derating (MTP)	Yes		
Constant Lumen Over Lifetime (CLO)	Yes		
Diagnostics	Yes		
Adjustable Light Output ALO	Yes		
LineSwitch	Yes		
Adjustable Start-up Time AST	Yes		
Integrated Dynadimmer	Yes		
End Of Life indicator	Yes		

Features

Specification item	Value	Remark	Condition
Open load protection	Yes		Automatic recovering
Short circuit protection	Yes		Automatic recovering
Over power protection	Yes		Automatic recovering
Hot wiring	No		
Suitable for fixtures with protection class	I and II		per IEC60598
Over temperature protection driver	Yes		Automatic recovery
Overheating protection	Yes		Automatic recovering

Certificates and standards

Specification item	Value
Approval marks	CB / CE / ENEC / VDE-S
Ingress Protection classification	20

Inrush current

Specification item	Value	Unit	Condition
Inrush current I_{peak}		A	Input voltage 230V
Inrush current T_{width}		μ s	Input voltage 230V, measured at 50% I_{peak}
Drivers / MCB 16A type B	≤ 25	pcs	

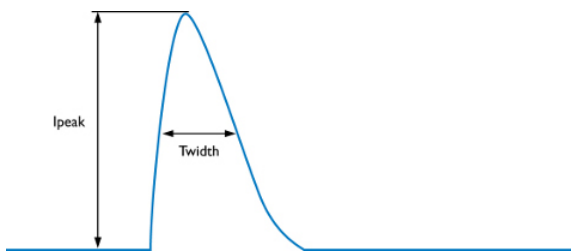

MCB	Rating	Relative number of LED drivers
B	10A	63%
B	13A	81%
B	16A	100% (stated in datasheet)
B	20A	125%
B	25A	156%
C	10A	104%
C	13A	135%
C	16A	170%
C	20A	208%
C	25A	260%

Driver touch current

Specification item	Value	Unit	Condition
Typical touch current	0.34	mA peak	Acc. IEC61347-1. LED module contribution not included

Surge immunity

Specification item	Value	Unit	Condition
Mains surge immunity (diff. mode)	6	kV	Acc. IEC61000-4-5. 2 Ohm, 1.2/50us, 8/20us
Mains surge immunity (comm. mode)	8	kV	Acc. IEC61000-4-5. 12 Ohm 1.2/50us,8/20us
Control surge immunity (diff. mode)	1	kV	Acc. IEC61000-4-5. 2 Ohm, 1.2/50us, 8/20us
Control surge immunity (comm. mode)	2	kV	Acc. IEC61000-4-5. 12 Ohm, 1.2/50us, 8/20us

Additional information

Specification item	Value	Unit	Condition
AOC	700	mA	
LineSwitch	ON		
ALO	ON		
CLO	100	%	
MTP	ON		
Dynadimmer	OFF		
AST	ON		
EOL	OFF		

Graphs

Operating window

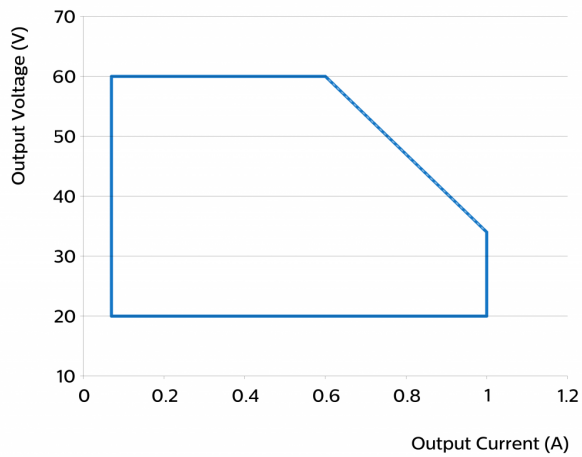

Power factor versus output power

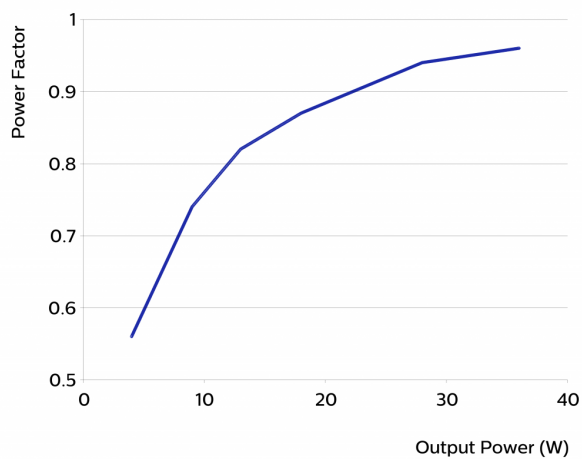

Efficiency versus output power

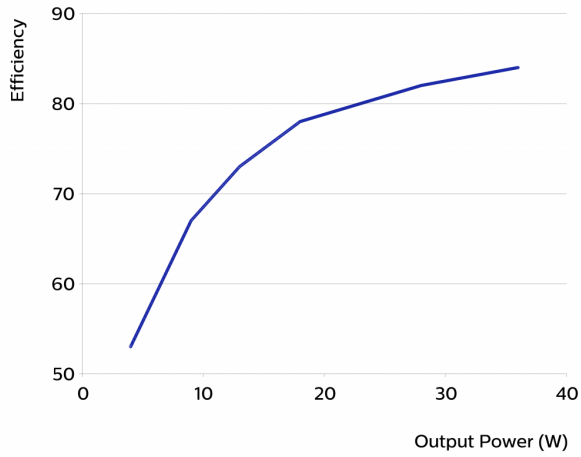

THD versus output power

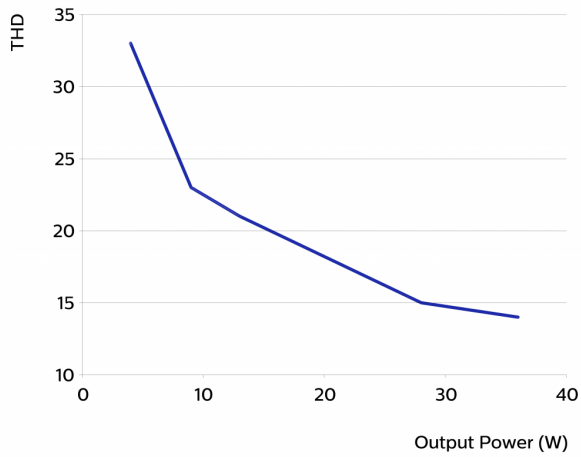

©2015 Koninklijke Philips Electronics N.V.

All rights reserved. Reproduction in whole or in part is prohibited without the prior written consent of the copyright owner. The information presented in this document does not form part of any quotation or contract, is believed to be accurate and reliable and may be changed without notice. No liability will be accepted by the publisher for any consequence of its use. Publication thereof does not convey nor imply any license under patent- or other industrial or intellectual property rights. Data subject to change.

Date of release: July 24, 2015

www.philips.com/technology