

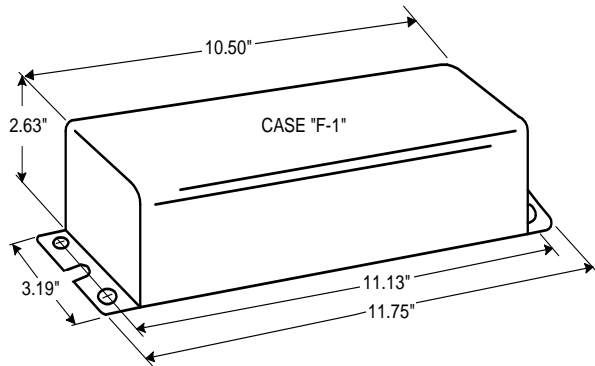

High Pressure
Sodium
Lamp Ballast

Catalog Number 72C7884
For 50W S68
60 Hz HX-HPF
Status: Active

DIMENSIONS AND DATA



INPUT VOLTS	120	277			
CIRCUIT TYPE	HX-HPF				
POWER FACTOR (min)	90%				
REGULATION					
Line Volts	±5%				
Lamp Watts	WITHIN TRAPEZOID				
LINE CURRENT (Amps)					
Operating.....	0.65	0.30			
Open Circuit.....	1.40	0.62			
Starting.....	0.70	0.35			
UL TEMPERATURE RATINGS					
Insulation Class	A (105°C)				
Coil Temperature Code	1029				
MIN. AMBIENT STARTING TEMP.	-40°F or -40°C				
NOM. OPEN CIRCUIT VOLTAGE	120				
INPUT VOLTAGE AT LAMP DROPOUT.....	90	208			
INPUT WATTS	65				
RECOMMENDED FUSE (Amps).....	4	2			
CORE and COIL					
Dimension (A)					
Dimension (B)					
Weight (lbs.)	11				
Lead Lengths	12"				
CAPACITOR REQUIREMENT					
Microfarads					
Volts (min.)					
Fault Current Withstand (amps)					
60 Hz TEST PROCEDURES (Refer to Advance Test Procedure for HID Ballasts - Form 1270)					
High Potential Test (Volts)					
1 minute	1600				
2 seconds	2000				
Open Circuit Voltage Test (Volts)	110-130				
Short-Circuit Current Test (Amps)					
Secondary Current	1.55-1.95				
Input Current.....	0.60-0.95	0.28-0.42	-	-	-

Capacitor:

The capacitor is included as part of the potted assembly.

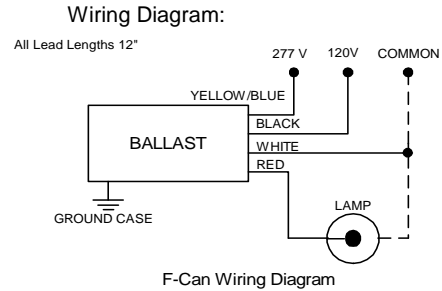

Ordering Information

Order Suffix	Description
IN CAN	

Ignitor: IN CAN

The ignitor is included as part of the potted assembly.

Ballast to Lamp Distance (BTL) = 15 feet
Temp Rating: 90°C

Data is based upon tests performed by Advance Transformer in a controlled environment and representative of relative performance. Actual performance can vary depending on operating conditions. Specifications are subject to change without notice.

ADVANCE TRANSFORMER CO.

O'HARE INTERNATIONAL CENTER · 10275 WEST HIGGINS ROAD · ROSEMONT, IL 60018
Customer Support/Technical Service: Phone: 800-372-3331 · Fax: 847-768-7768
Corporate Offices: Phone: 800-322-2086

09/03/99