

## Electrical Specifications

XI150C035V425MPH1	
Brand Name	XITANIUM
Description	Xitanium 150W 0.35A Prog+ GL-H sXt
Input Voltage	120~230~277
Input Frequency	50/60Hz
RoHS	Yes
Status	Active

Output Power (W)	Output Voltage (V)	Output Current (A)	Efficiency@ Max Load			Max Case Temp. (°C)	Input Current				Max. Input Power (W)	Inrush Current (A <sub>in</sub> /50%- $\mu$ s)		THD @ Max Load (%)	Power Factor @ Max Load	Surge Protection Common/Diff (KV)	Weight (Lbs/kgs)
			120 V	230 V	277 V		1 2 0	2 0 0	2 4 0	2 7 7		120 Vin	60/140				
150	212 ~ 425	0.2 ~ 0.35	91	93.0	93.0	80 °C	1.4	0.85	0.7	0.6	165	20	>0.95	4/4	1.8/ 0.8		

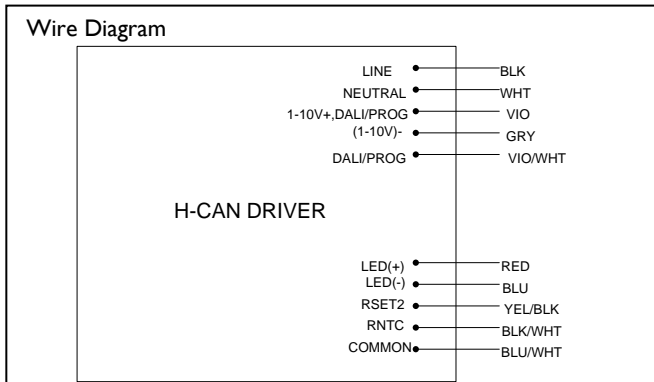

Input and output use lead- wires.  
 Lead-wires are 18AWG 105C/600V solid copper.  
 Length of wires coming out of the can

WIRE	LEAD LENGTH OUT OF CAN
INPUT LINE & NEUTRAL WIRE (BLK, WHT)	485mm (+/-10mm)
DIM & DALI WIRES (VIO, GRY, VIO/WHT)	440mm (+/-10mm)
OUTPUT WIRES (RED, BLU)	510mm (+/- 10mm)
OUTPUT CONTROL WIRES (YEL/BLK, BLK/WHT, BLU/WHT)	510mm (+/-10mm)

Dimming Method	Dimming Range	Minimum Output Current (A)	Min (typ). Output Power(W)	Other Comments
1-10V Isolated	10% ~ 100%	0.035	30	Dimming source current: 150 $\mu$ A
DALI	1 ~ 255   10% ~ 100%	0.035	30	Linear or Logarithmic variation
AmpDim	30% ~ 100%	0.105	30	Linear

## Enclosure

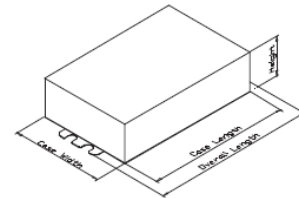

	in. (mm)*
Case Length	5.7(144)
Case Width	3.6(92)
Case Height	1.5(38)
Mounting Length	6(152)
Mounting Width	2.9(73)
Overall Length	6.3(161)

\* These dimensions do not include the tolerance



Revised 04/04/2012

## PHILIPS LIGHTING ELECTRONICS N.A.

10275 WEST HIGGINS ROAD · ROSEMONT, IL 60018  
 Tel: 800-322-2086 · Fax: 888-423-1882 · www.philips.com/advance  
 Customer Support/Technical Service: 800-372-3331 · OEM Support: 866-915-5886



## Electrical Specifications

<b>XI150C035V425MPH1</b>	
Brand Name	XITANIUM
Description	Xitanium 150W 0.35A Prog+ GL-H sXt
Input Voltage	120~230~277
Input Frequency	50/60Hz
RoHS	Yes
Status	Active

<b>Product Data</b>	
Order code	XI150C035V425MPH1
Full product code	XI150C035V425MPH1
Full product name	Xitanium 150W 0.35A Prog+ GL-H sXt
Net weight per piece	0.8KG/1.76 Lb
Interfaces	1-10V Dimming, DALI, AmpDim, Integrated Dynadimmer, AOC, MTP, CLO, OTL
Ambient Temp Range	-40C to +55C
Corresponding Tcase	-15C to +80C
Cycling Temperature	-20C to -40C limited to (400cycles max)
Line Voltage	120-277V
Line Current	1.4A @ 120V, 0.7A @ 240V, 0.6 @ 277V
Line Frequency	50/60Hz
Life @ TC 70 C	100000 hr [nom] refer to graph below
Life @ TC 80 C	48000 hr [nom] refer to graph below
Suitable for Outdoor use?	Yes
Max TC	80C
Inrush current Width	Refer to table
LED Current Tolerance	+/-5%
Earth leakage current	0.7 mA [max]
Mains voltage safety (AC)	+/-10%
Mains voltage performance (AC)	+/-10%
Min. Mains voltage operational	108 V [min]
Output peak voltage	425 V [max]
Output Current ripple	30% @ 350 mA (ripple = pk-pk/avg)
THD total	< 20%
THD 3 <sup>rd</sup> Harmonic	< 15%
PF @ Max Load	>0.95
Wire Isolation	All wires are Double isolated to ground
Protections	Short Circuit and Open Circuit Protection for LED + and LED-
Standby power	<1.0W

Revised 04/04/2012

**PHILIPS LIGHTING ELECTRONICS N.A.**  
10275 WEST HIGGINS ROAD · ROSEMONT, IL 60018  
Tel: 800-322-2086 · Fax: 888-423-1882 · www.philips.com/advance  
Customer Support/Technical Service: 800-372-3331 · OEM Support: 866-915-5886



## XI150C035V425MPH1

Brand Name	XITANIUM
Description	Xitanium 150W 0.35A Prog+ GL-H sXt
Input Voltage	120~230~277
Input Frequency	50/60Hz
RoHS	Yes
Status	Active

### Electrical Specifications

#### Installation & Application Notes:

##### Section I – Physical Characteristics

- 1.1 LED Driver shall be installed inside an electrical enclosure
- 1.2 Wiring inside electrical enclosure shall comply with 600V/105°C rating or higher.

##### Section II – Performance

- 2.1 LED Driver has a rated lifetime of 50,000 hours @ TC <=80C.
- 2.2 LED Driver tolerates sustained open circuit and short circuit output conditions without damage.
- 2.3 LED Driver maximum allowable case temperature is 80°C – see product label for measurement location.
- 2.4 LED Driver reduces output power to LEDs if its case temperature exceeds >90°C –thermal protection and eventually reduces output current to zero.
- 2.5 LED Driver complies with the requirements of UL, CSA, CE, ENEC and CISPR 15 Ed 7.2

#### ELECTRICAL RATINGS:

Model	Input, 50/60 Hz		Output (Nominal)		
	V	A	V DC	mA DC	Watts
XI150C035V425MPH1, 9290007075	120-277	1.4/0.61	212-425	200-350	150

#### TECHNICAL CONSIDERATIONS (NOT FOR FIELD REPRESENTATIVE'S USE):

##### Section III – Conditions of acceptability

When installed in the end-use equipment, the following are among the considerations to be made:

- 3.1 The equipment shall be installed in compliance with the enclosure, mounting, spacing, casualty and segregation requirements of the ultimate application.
- 3.2 The driver case must be grounded in the end-use application.
- 3.3 The driver is suitable for use in "DAMP" and "DRY" locations.
- 3.4 The dimming circuits (0-10V, Dali) should be considered as part of the primary circuit in the end-use application.
- 3.5 When the drivers are installed in the end-use application, the case temperature should not exceed the temperature limits specified in the following table:

Model No.	Input Voltage, Hz	Max. Case @ Tc, °C
XI150C035V425MPH1, 9290007075	120-277, 50/60	80

- 3.6 The leakage current test should be repeated in the end device. In tests, as a Component, test results using Simpson 228 leakage current meter were higher than 0.5 MIU but lower than 0.75 MIU. The measured leakage current values were as follows:

Model Number	Test Voltage, V, 60 Hz	Measured Leakage, MIU
XI150C035V425MPH1, 9290007075	120	0.30
XI150C035V425MPH1, 9290007075	277	0.74

Revised 04/04/2012

### PHILIPS LIGHTING ELECTRONICS N.A.

10275 WEST HIGGINS ROAD · ROSEMONT, IL 60018

Tel: 800-322-2086 · Fax: 888-423-1882 · www.philips.com/advance

Customer Support/Technical Service: 800-372-3331 · OEM Support: 866-915-5886

## XI150C035V425MPH1

Brand Name	XITANIUM
Description	Xitanium 150W 0.35A Prog+ GL-H sXt
Input Voltage	120~230~277
Input Frequency	50/60Hz
RoHS	Yes
Status	Active

### Electrical Specifications

#### AOC (Adjustable Output Current) Settings:

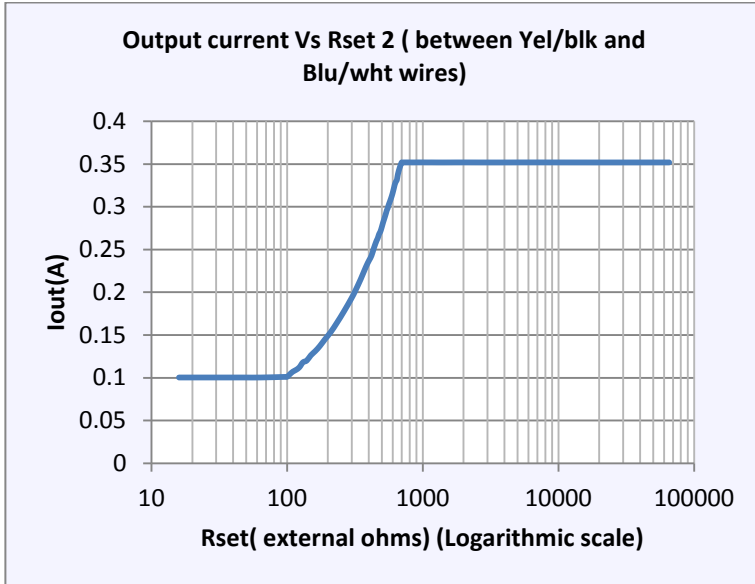

Rset (Ohms)	Current(A)
1	0.1
100	0.1
120	0.11
150	0.125
200	0.146
240	0.165
300	0.19
390	0.228
470	0.26
510	0.277
620	0.318
680	0.34
710	0.35
1000000	0.35

#### Operating voltage and current

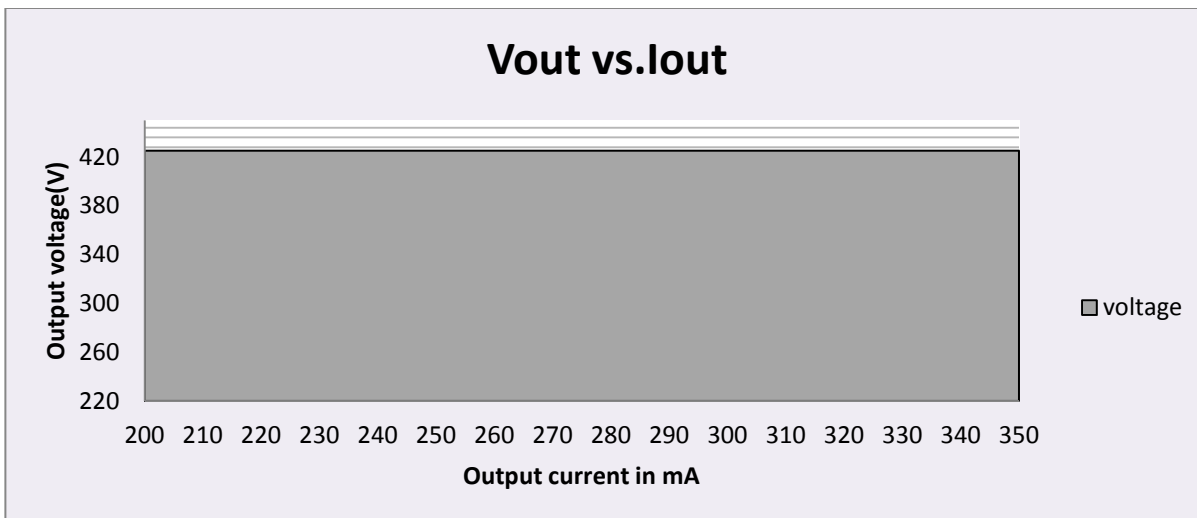

Revised 04/04/2012

### PHILIPS LIGHTING ELECTRONICS N.A.

10275 WEST HIGGINS ROAD · ROSEMONT, IL 60018

Tel: 800-322-2086 · Fax: 888-423-1882 · [www.philips.com/advance](http://www.philips.com/advance)

Customer Support/Technical Service: 800-372-3331 · OEM Support: 866-915-5886



## XI150C035V425MPH1

Brand Name	XITANIUM
Description	Xtanium 150W 0.35A Prog+ GL-H sXt
Input Voltage	120~230~277
Input Frequency	50/60Hz
RoHS	Yes
Status	Active

### Electrical Specifications

#### Temperature Profile Settings:

Module Thermal protection can be implemented between 55C to 85 C.

Two NTC parts can be used: NTC1 from Murata Part Number NCP18XH103J03RB

NTC2 from Murata Part Number NCP15XW153E03RC

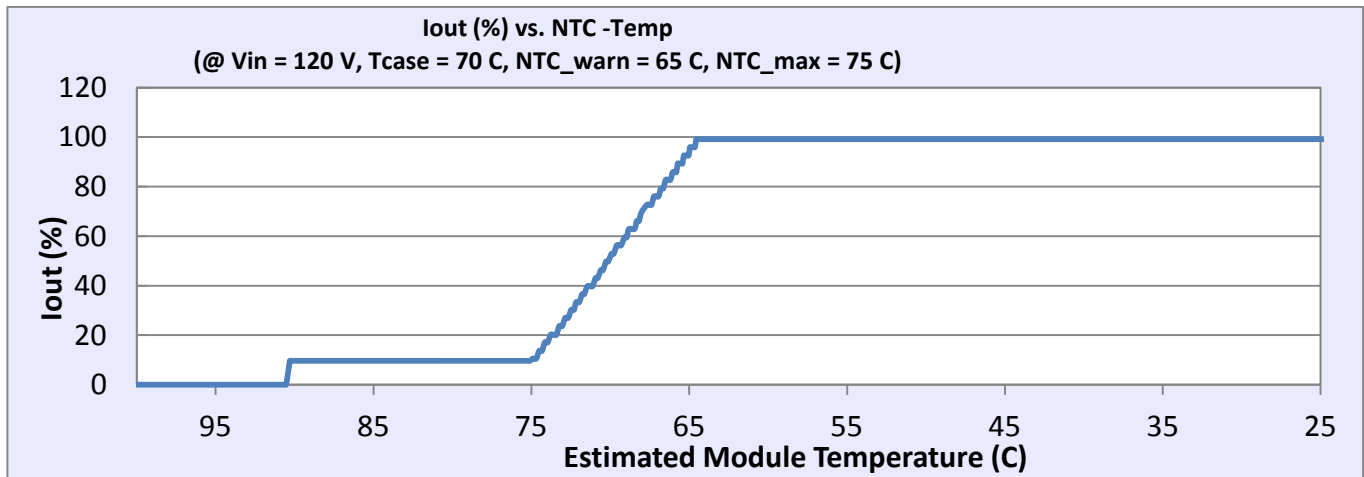

#### 1-10V Dimming Curve:

Dimming source current from the driver: 150  $\mu$ A (+/- 3%). LED Current tolerance at any value of Vdim: +/- 5% of Imax.

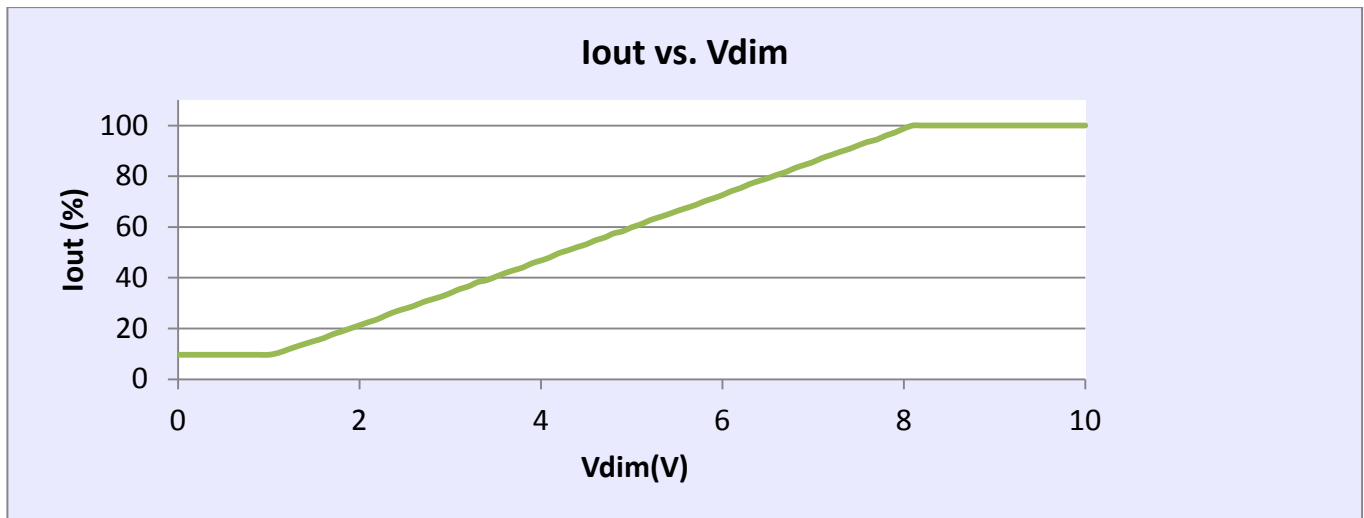

Revised 04/04/2012

### PHILIPS LIGHTING ELECTRONICS N.A.

10275 WEST HIGGINS ROAD · ROSEMONT, IL 60018

Tel: 800-322-2086 · Fax: 888-423-1882 · [www.philips.com/advance](http://www.philips.com/advance)

Customer Support/Technical Service: 800-372-3331 · OEM Support: 866-915-5886



## XI150C035V425MPH1

Brand Name	XITANIUM
Description	Xitanium 150W 0.35A Prog+ GL-H sXt
Input Voltage	120~230~277
Input Frequency	50/60Hz
RoHS	Yes
Status	Active

### Electrical Specifications

#### AmpDim Curve:

Parameter	Min	Max	Increments
Start Voltage	170V	250V	1V (configurable by software)
Stop Voltage	150V	230V	1V (configurable by software)
Start Percent	30%	100%	1% (configurable by software)
Stop Percent	30%	100%	1% (configurable by software)

Current Tolerance (@70C) : \_\_\_\_\_

Fade Time: 2s (+/- 10%)

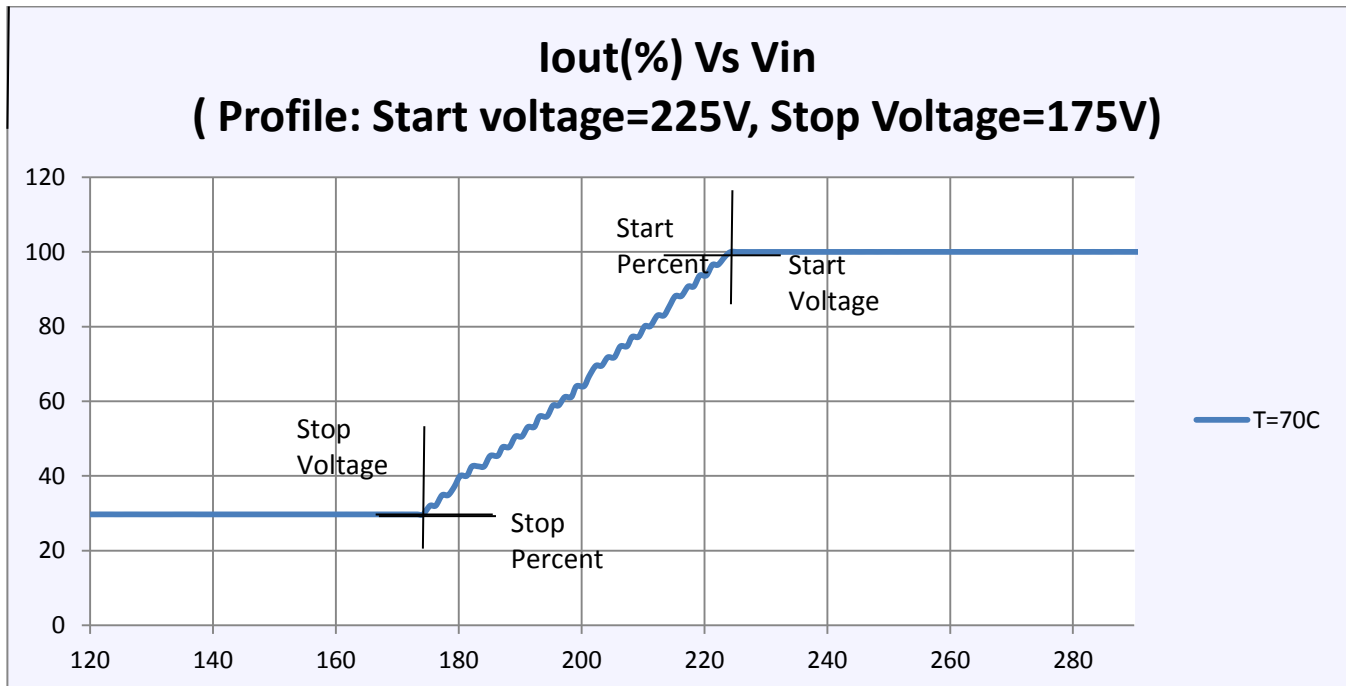

Revised 04/04/2012

#### PHILIPS LIGHTING ELECTRONICS N.A.

10275 WEST HIGGINS ROAD · ROSEMONT, IL 60018

Tel: 800-322-2086 · Fax: 888-423-1882 · [www.philips.com/advance](http://www.philips.com/advance)

Customer Support/Technical Service: 800-372-3331 · OEM Support: 866-915-5886



XI150C035V425MPH1	
Brand Name	XITANIUM
Description	Xitanium 150W 0.35A Prog+ GL-H sXt
Input Voltage	120~230~277
Input Frequency	50/60Hz
RoHS	Yes
Status	Active

## Electrical Specifications

### Efficiency Curves :

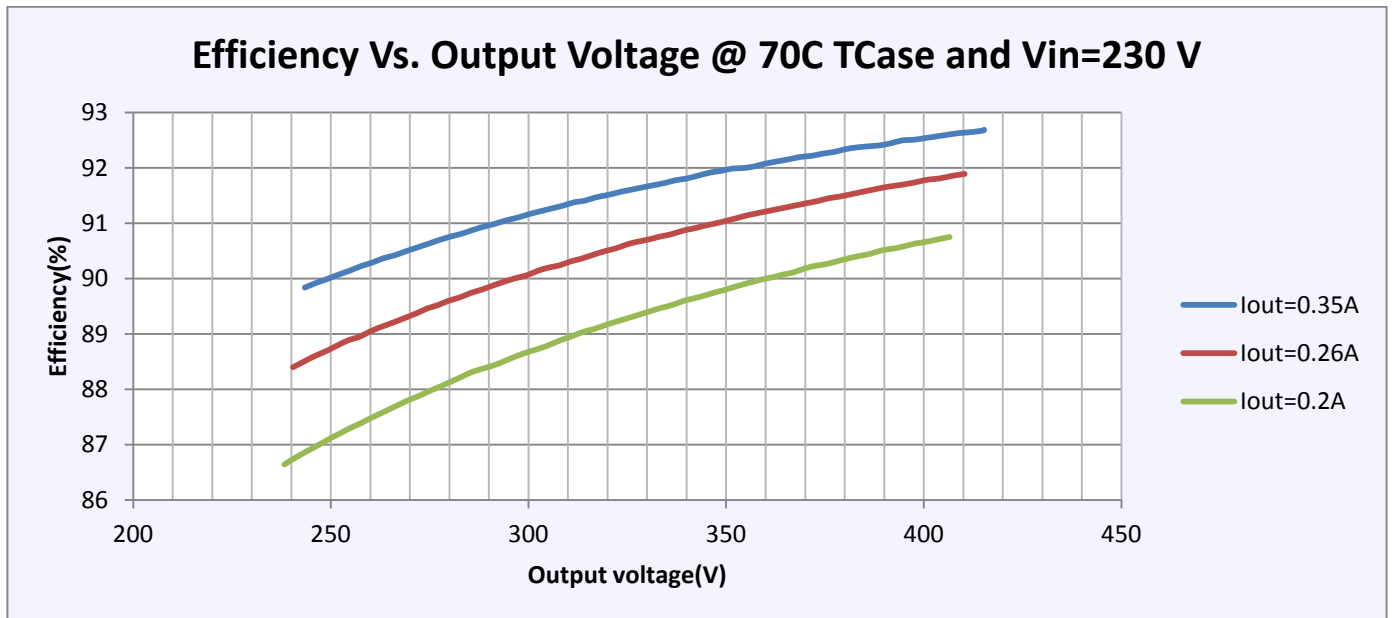
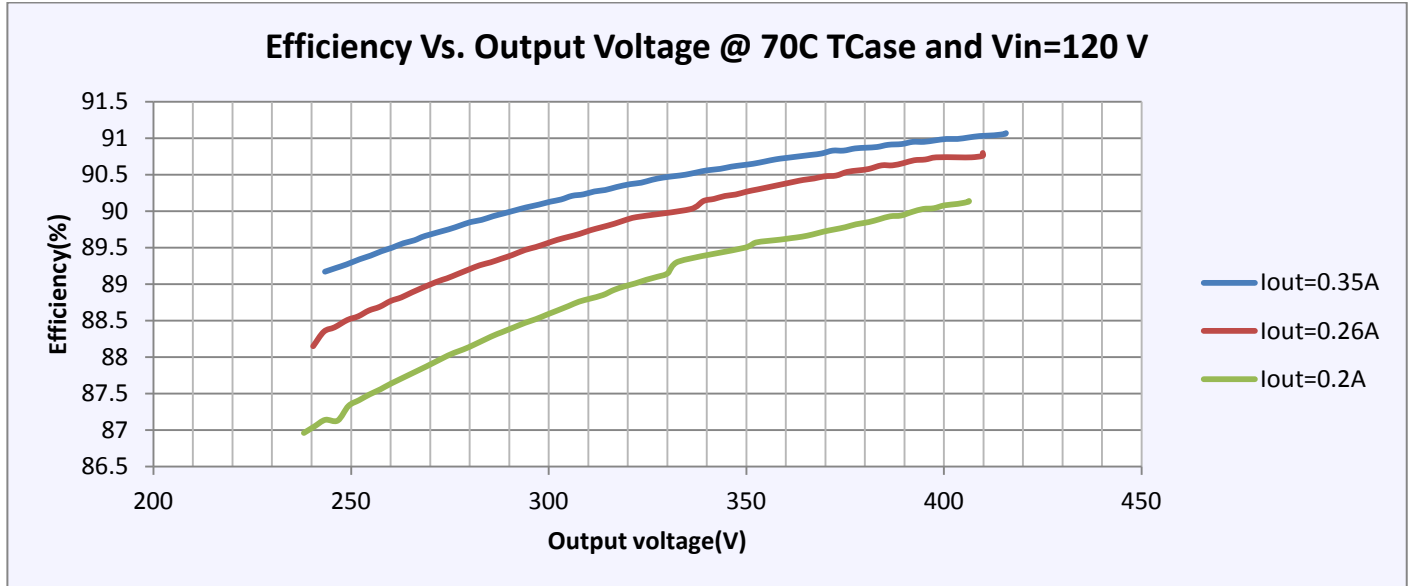

Revised 04/04/2012



## XI150C035V425MPH1

Brand Name	XITANIUM
Description	Xtanium 150W 0.35A Prog+ GL-H sXt
Input Voltage	120~230~277
Input Frequency	50/60Hz
RoHS	Yes
Status	Active

### Electrical Specifications

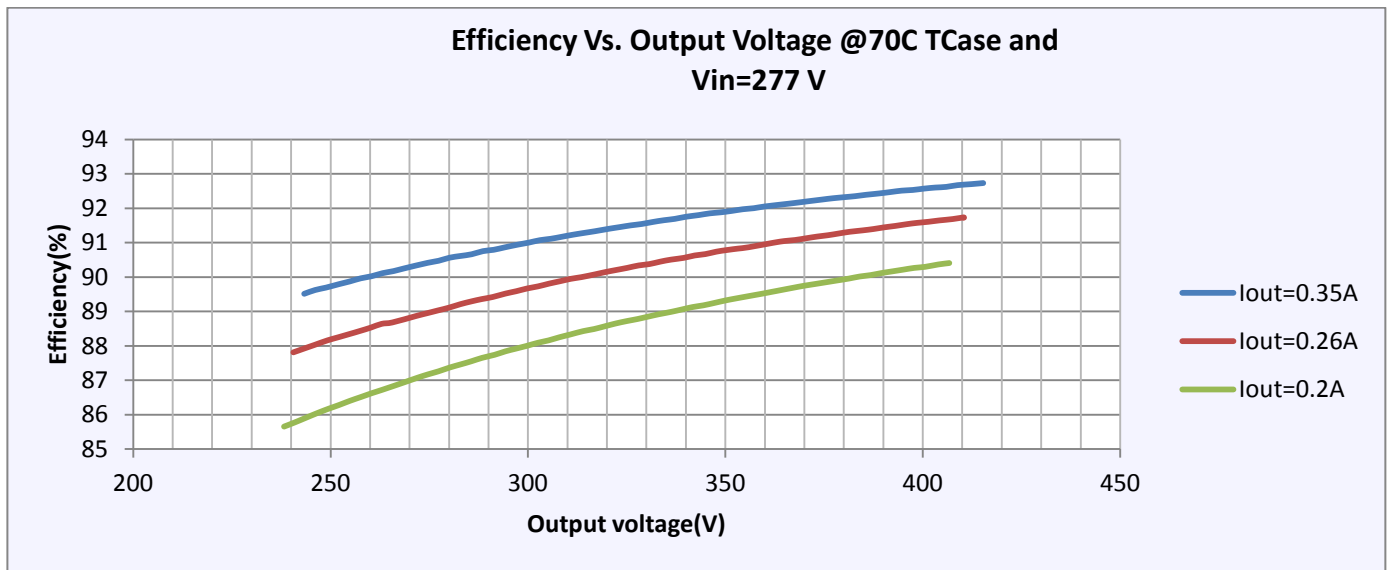

### Power Factor Curve:

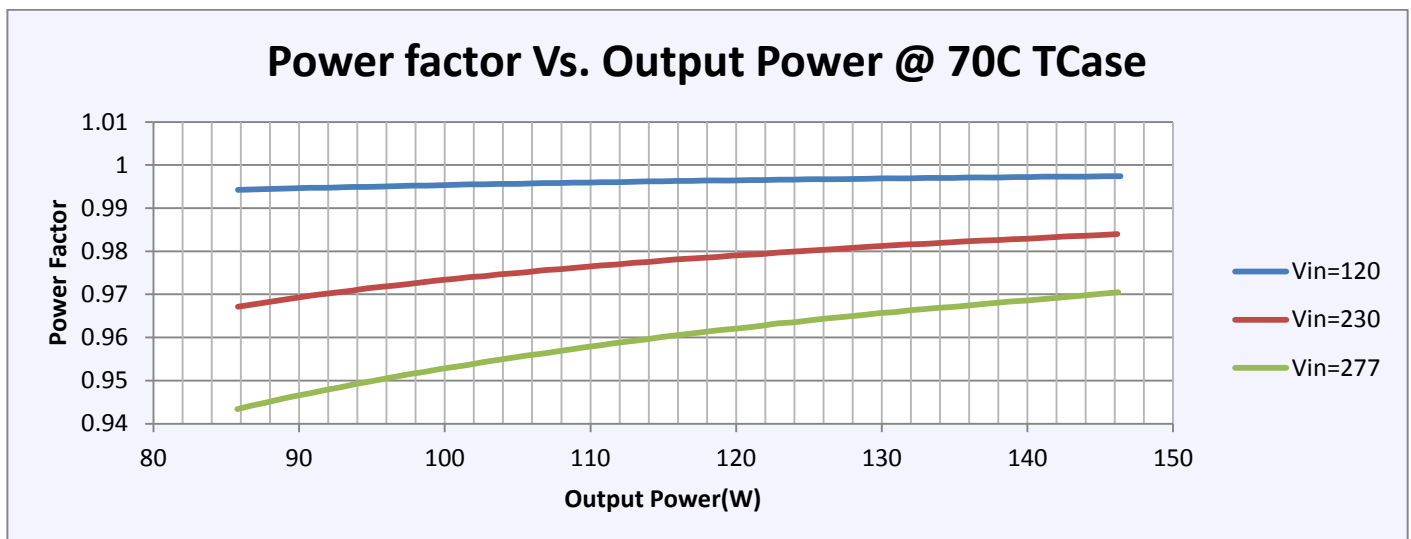

Revised 04/04/2012



## XI150C035V425MPH1

Brand Name	XITANIUM
Description	Xitanium 150W 0.35A Prog+ GL-H sXt
Input Voltage	120~230~277
Input Frequency	50/60Hz
RoHS	Yes
Status	Active

### Electrical Specifications

Programming Tool: For latest version please check [www.philips.com/xitanium](http://www.philips.com/xitanium)

### lout vs. Tcase of Driver:

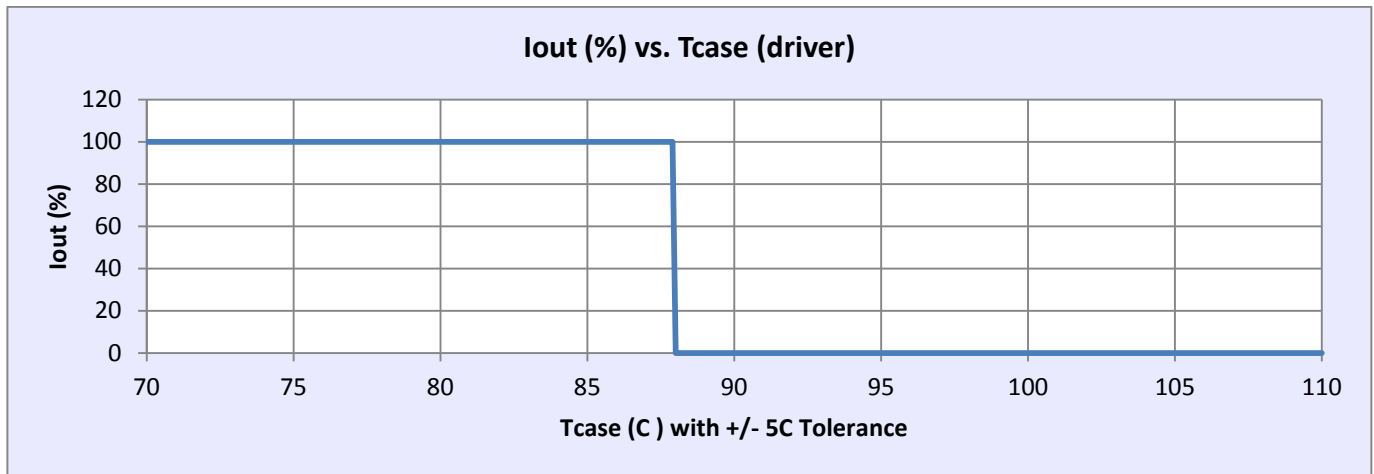

### Inrush Current Info:

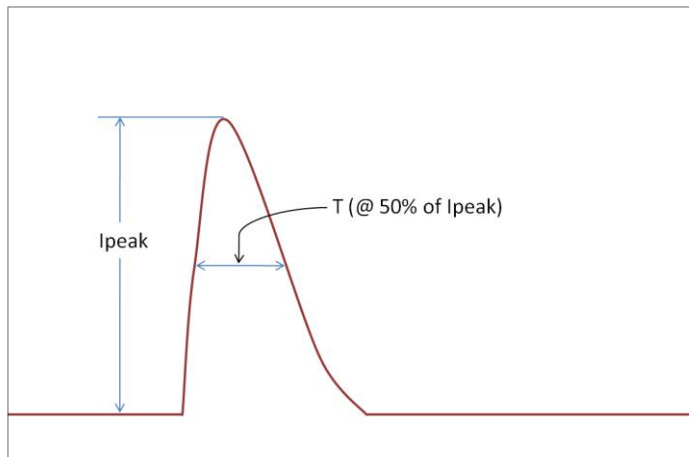

Vin	Ipeak	T (@ 50% of Ipeak)
120 Vrms	60 A	140 $\mu$ s
230 Vrms	118 A	140 $\mu$ s
277 Vrms	140 A	140 $\mu$ s
305 Vrms	160 A	140 $\mu$ s

Revised 04/04/2012



### XI150C035V425MPH1

Brand Name	XITANIUM
Description	Xitanium 150W 0.35A Prog+ GL-H sXt
Input Voltage	120~230~277
Input Frequency	50/60Hz
RoHS	Yes
Status	Active

### Electrical Specifications

### Lifetime vs. Tcase of Driver:

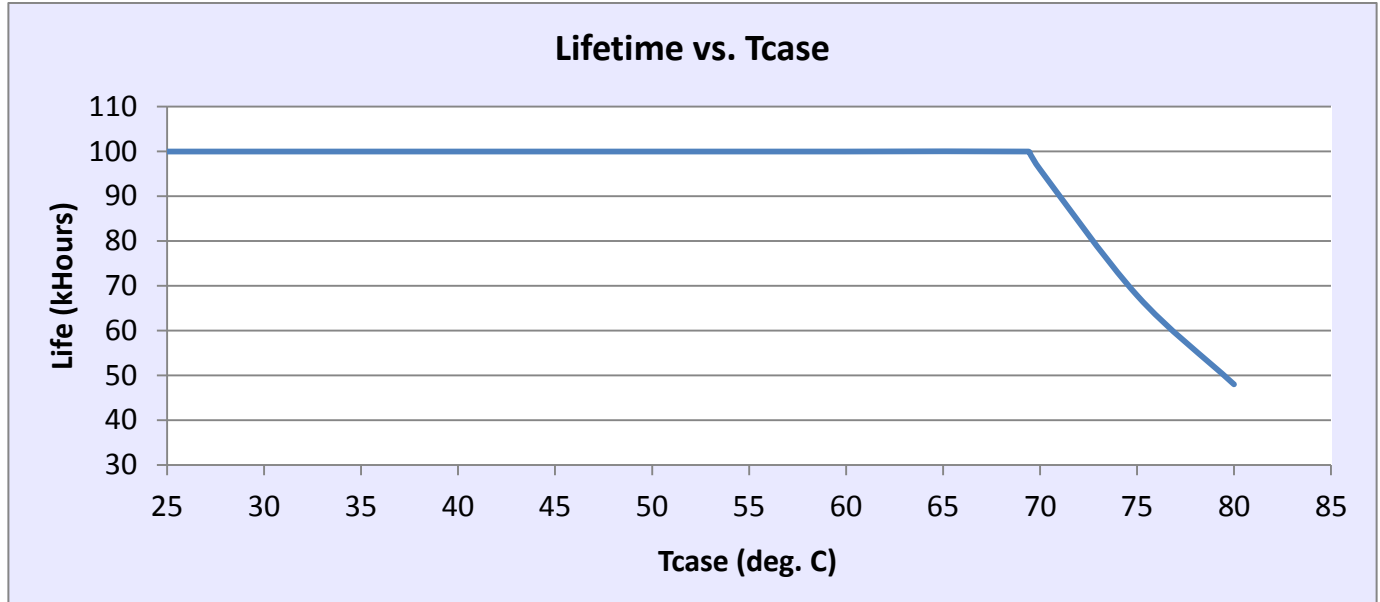

### Failure Rate info based upon MTBF modeling:

- 90% survivals at end of life @<= Tcase 70 C

### Failure Rate Info based upon field call rate data:

1. <0.01% per 1 kHr @<= Tcase 70 C.

### Isolation:

Isolation	Input Wires	Output Wires	DALI Wires	0-10V Wires	Chassis
Input Wires	NA	1750	1750	1750	3750
Output Wires+ Control Wires	1750	NA	1750	1750	3750
DALI Wires	1750	1750	NA	NA	3750
0-10V Wires	1750	1750	NA	NA	3750
Chassis	3750	3750	3750	3750	NA

Revised 04/04/2012

### PHILIPS LIGHTING ELECTRONICS N.A.

10275 WEST HIGGINS ROAD · ROSEMONT, IL 60018  
 Tel: 800-322-2086 · Fax: 888-423-1882 · www.philips.com/advance  
 Customer Support/Technical Service: 800-372-3331 · OEM Support: 866-915-5886



## XI150C035V425MPH1

Brand Name	XITANIUM
Description	Xitanium 150W 0.35A Prog+ GL-H sXt
Input Voltage	120~230~277
Input Frequency	50/60Hz
RoHS	Yes
Status	Active

### Electrical Specifications

#### Revision History:

Rev No.	Date	Description	Approval	Remarks
1.1	01/30/2012	*Add Electrical Rating Table and COA	N.T.	
1.2	02/06/2012	*Revise Output peak voltage	N.T.	
1.3	03/02/2012	*Remove the "M" in the part#	N.T.	
1.4	03/07/2012	*Update Status to "Active"	N.T.	
1.5	04/04/2012	*Add Cycling Temperature to Product Data Table	N.T.	

Revised 04/04/2012

**PHILIPS LIGHTING ELECTRONICS N.A.**  
10275 WEST HIGGINS ROAD · ROSEMONT, IL 60018  
Tel: 800-322-2086 · Fax: 888-423-1882 · [www.philips.com/advance](http://www.philips.com/advance)  
Customer Support/Technical Service: 800-372-3331 · OEM Support: 866-915-5886