

<b>9290 007 05113</b>	
Brand Name	XITANIUM
Description	Xitanium 150W .35-.7A GL Prog+ sXt
Input Voltage	120~200~240~277
Input Frequency	50/60Hz
RoHS	Yes
Status	Active

## Electrical Specifications

Output Power (W)	Output Voltage (V)	Output Current (A)	Efficiency@ Max Load			Max Case Temp. (°C)	Input Current				Max. Input Power (W)	Inrush Current (A <sub>in</sub> /50%- $\mu$ s)		THD @ Max Load (%)	Power Factor @ Max Load	Surge Protection Common/Diff (KV)	Weight (Lbs/kgs)	Envir. Protection Rating
			120 V	230 V	277 V		120	200	240	277		120 Vin	58/140					
150	125 ~ 280	0.350 – 0.70	91.5	93.0	93.0	80 °C	1.4	0.85	0.7	0.6	165	120 Vin	58/140	20	>0.95	4/4	2.8/ 1.27	UL Dry & Damp

### Wire Diagram

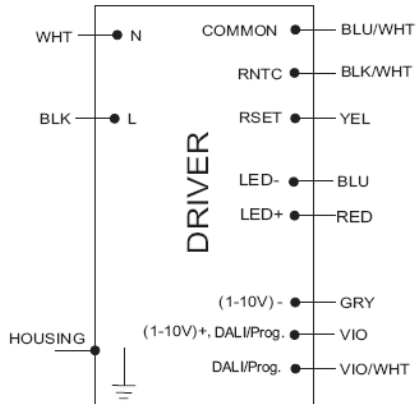

Input and output use lead-wires.  
Lead-wires are 18AWG 105C/600V solid copper.

Standard Lead Length is 500mm+/-10mm on all wires outside the can

Dimming Method	Dimming Range		Minimum Output Current (A)	Other Comments
1-10V Isolated	10% ~ 100%		0.050	Dimming source current: 150 $\mu$ A
DALI	1 ~ 254	10% ~ 100%	0.050	Linear or Logarithmic variation
Amp Dimming	30% ~ 100%		0.105	Linear

### Enclosure



	in. (mm)
Case Length	8.38 (211.1)
Case Width	2.35 (59.1)
Case Height	1.47 (37.1)
Mounting Length	9.0 (226.2)
Mounting Width	1.7 (42.9)
Overall Length	9.54 (240.5)



7 8 1 0 8 7 0 9 1 5 3 1

Revised 04/05/2012

**PHILIPS LIGHTING ELECTRONICS N.A.**  
10275 WEST HIGGINS ROAD · ROSEMONT, IL 60018  
Tel: 800-322-2086 · Fax: 888-423-1882 · www.philips.com/advance  
Customer Support/Technical Service: 800-372-3331 · OEM Support: 866-915-5886



## Electrical Specifications

<b>9290 007 05113</b>	
Brand Name	XITANIUM
Description	Xitanium 150W .35-.7A GL Prog+ sXt
Input Voltage	120~200~240~277
Input Frequency	50/60Hz
RoHS	Yes
Status	Active

<b>Product Data</b>	
Order code	929000705113
Full product code	929000705113
Full product name	Xitanium150W 0.35-0.7A GL Prog+ sXt
Net weight per piece	1.27 KG / 2.8 lbs
Interfaces	1-10V Dimming, DALI, Amp Dimming, Integrated Dynadimmer, AOC, MTP, CLO, OTL
Ambient Temp Range	-40C to +55C
Corresponding Tcase	-15C to +80C
Cycling Temperature	-20C to -40C limited to (400cycles max)
Line Voltage	120-277V
Line Current	1.4A @ 120V, 0.7A @ 240V, 0.6 @ 277V
Line Frequency	50/60Hz
Envir. Protection Rating	UL Dry & Damp
Life @ TC 70 C	100000 hr [nom] refer to graph below
Life @ TC 80 C	48000 hr [nom] refer to graph below
Suitable for Outdoor use?	Yes
Max TC	80C
Inrush current Width	Refer to table
Maximum ballast number on MCB 16A	11 [max]
Input Over-voltage	Can survive input over-voltage stress of 320VAC for 48 hours and 350VAC for 2 hours
LED Current Tolerance	+/-5%
Earth leakage current	0.7 mA [max]
Mains voltage safety (AC)	+/-10%
Mains voltage performance (AC)	+/-10%
Min. Mains voltage operational	108 V [min]
Max. Mains voltage operational	305V [max]
Output Current ripple	30% @ 700 mA (ripple = pk-pk/avg)
THD total	< 20%
THD 3 <sup>rd</sup> Harmonic	< 15%
PF @ Max Load	>0.95
Wire Isolation	All wires are Double isolated to ground
Protections	Short Circuit and Open Circuit Protection for LED + and LED-
Standby power	<1.0W

Revised 04/05/2012

**PHILIPS LIGHTING ELECTRONICS N.A.**  
10275 WEST HIGGINS ROAD · ROSEMONT, IL 60018  
Tel: 800-322-2086 · Fax: 888-423-1882 · [www.philips.com/advance](http://www.philips.com/advance)  
Customer Support/Technical Service: 800-372-3331 · OEM Support: 866-915-5886



<b>9290 007 05113</b>	
Brand Name	XITANIUM
Description	Xitanium 150W .35-.7A GL Prog+ sXt
Input Voltage	120~200~240~277
Input Frequency	50/60Hz
RoHS	Yes
Status	Active

## Electrical Specifications

### Installation & Application Notes:

#### Section I – Physical Characteristics

- 1.1 LED Driver shall be installed inside an electrical enclosure
- 1.2 Wiring inside electrical enclosure shall comply with 600V/105°C rating or higher.

#### Section II – Performance

- 2.1 LED Driver has a rated lifetime of 50,000 hours @ TC <=80C.
- 2.2 LED Driver tolerates sustained open circuit and short circuit output conditions without damage.
- 2.3 LED Driver maximum allowable case temperature is 80°C – see product label for measurement location.
- 2.4 LED Driver reduces output power to LEDs if its case temperature exceeds >90°C –thermal protection and eventually reduces output current to zero.
- 2.5 LED Driver complies with the requirements of UL, CSA, CE, ENEC, CISPR 15 Ed 7.2 and CQC (TBD).

#### Section III – UL Conditions of acceptability (UL File# 321253):

When installed in the end-use equipment, the following are among the considerations to be made:

- 3.1 The equipment shall be installed in compliance with the enclosure, mounting, spacing, casualty and segregation requirements of the ultimate application.
- 3.2 The driver case must be grounded in the end-use application.
- 3.3 The driver is suitable for use in “DAMP” and “DRY” locations.
- 3.4 The secondary and dimming circuit should be considered as part of the primary circuit in the end-use application. Apart from the DALI and 10 V circuits, dimming can also be achieved via an external non-variable resistor connected to the leads identified as R set and Common. The resistor value is dependent on the desired output current according to the product specification sheet and can range 620 to 1000000 Ohms for 300mA to 700mA output.
- 3.5 When the drivers are installed in the end-use application, the case temperature should not exceed the temperature limits specified in the following table:

Model No.	Input Voltage, Hz	Max. Case @ Tc, °C
929000705113	120-277, 50/60	80

- 3.6 The leakage current test should be repeated in the end device. In tests, as a Component, test results were higher than 0.5 MIU but lower than 0.75 MIU.

Revised 04/05/2012



<b>9290 007 05113</b>	
Brand Name	XITANIUM
Description	Xitanium 150W .35-.7A GL Prog+ sXt
Input Voltage	120~200~240~277
Input Frequency	50/60Hz
RoHS	Yes
Status	Active

## Electrical Specifications

### AOC (Adjustable Output Current) Settings:

LED current tolerance with variation of Rset is within +/- 5% of I<sub>max</sub>

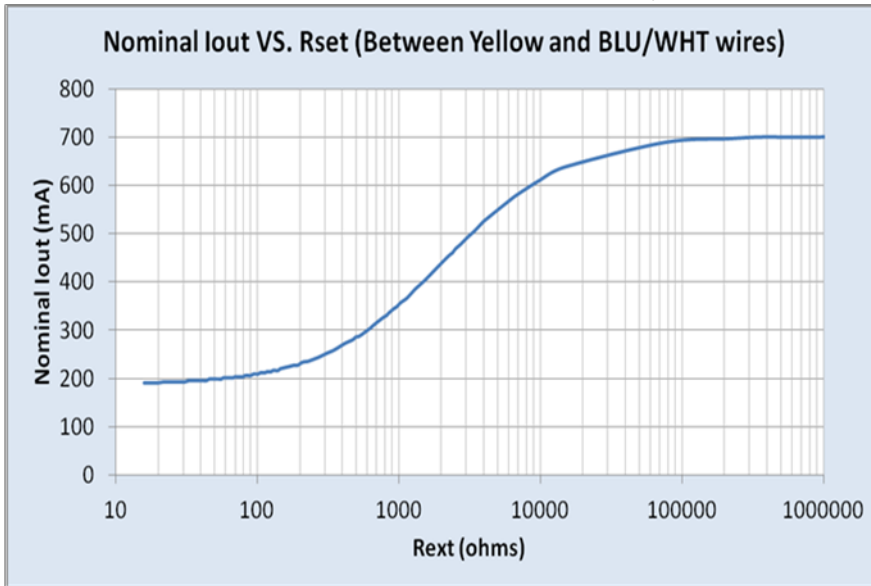

Rset (Ohms)	Current (mA)
1	191
100	214
620	309
910	347
935	350
1500	406
2200	455
3000	494
4115	530
4300	536
8200	599
18000	649
100000	691
1000000	700

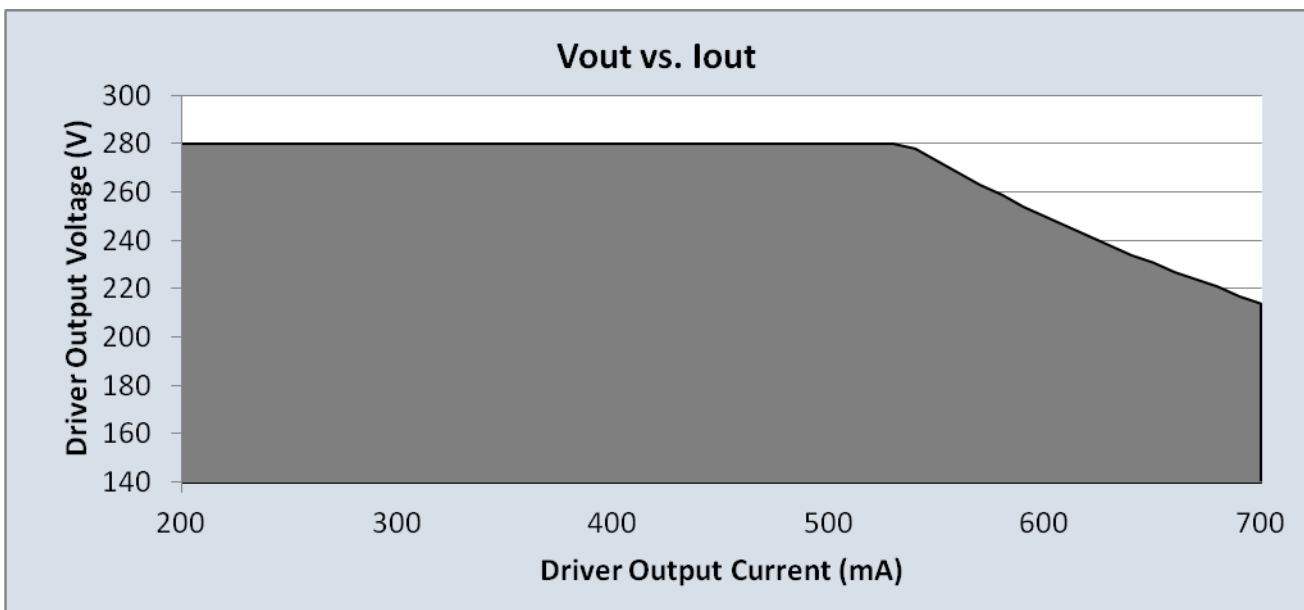

Revised 04/05/2012

**PHILIPS LIGHTING ELECTRONICS N.A.**  
10275 WEST HIGGINS ROAD · ROSEMONT, IL 60018  
Tel: 800-322-2086 · Fax: 888-423-1882 · [www.philips.com/advance](http://www.philips.com/advance)  
Customer Support/Technical Service: 800-372-3331 · OEM Support: 866-915-5886

9290 007 05113	
Brand Name	XITANIUM
Description	Xitanium 150W .35-.7A GL Prog+ sXt
Input Voltage	120~200~240~277
Input Frequency	50/60Hz
RoHS	Yes
Status	Active

## Electrical Specifications

**Module Thermal Protection** can be implemented between 50C to 85C. Please refer to design guide for more details

**Two NTC parts can be used:** NTC1 from Murata Part Number NCP18XH103J03RB

NTC2 from Murata Part Number NCP15XW153E03RC

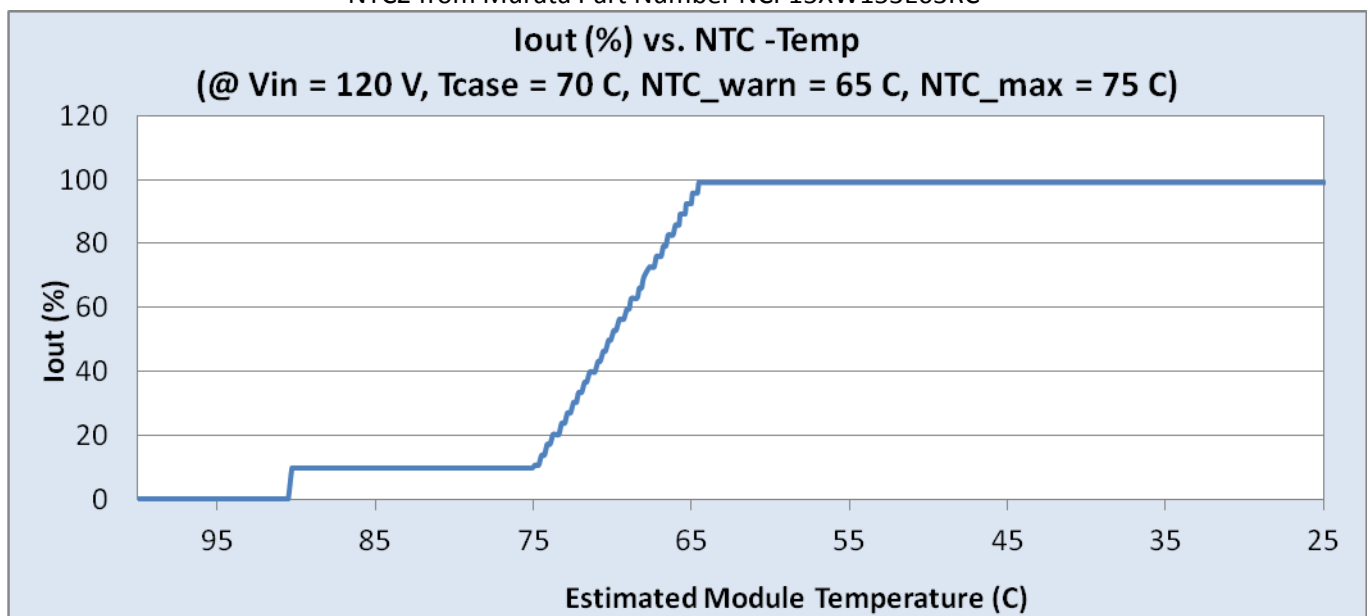

Revised 04/05/2012

**9290 007 05113**

Brand Name	XITANIUM
Description	Xitanium 150W .35-.7A GL Prog+ sXt
Input Voltage	120~200~240~277
Input Frequency	50/60Hz
RoHS	Yes
Status	Active

## Electrical Specifications

### **1-10V Dimming Curve:**

Dimming source current from the driver: 150  $\mu$ A (+/- 3%)

LED Current tolerance at any value of Vdim: +/- 5% of I<sub>max</sub>

Minimum Dim Level: 10% - 100%

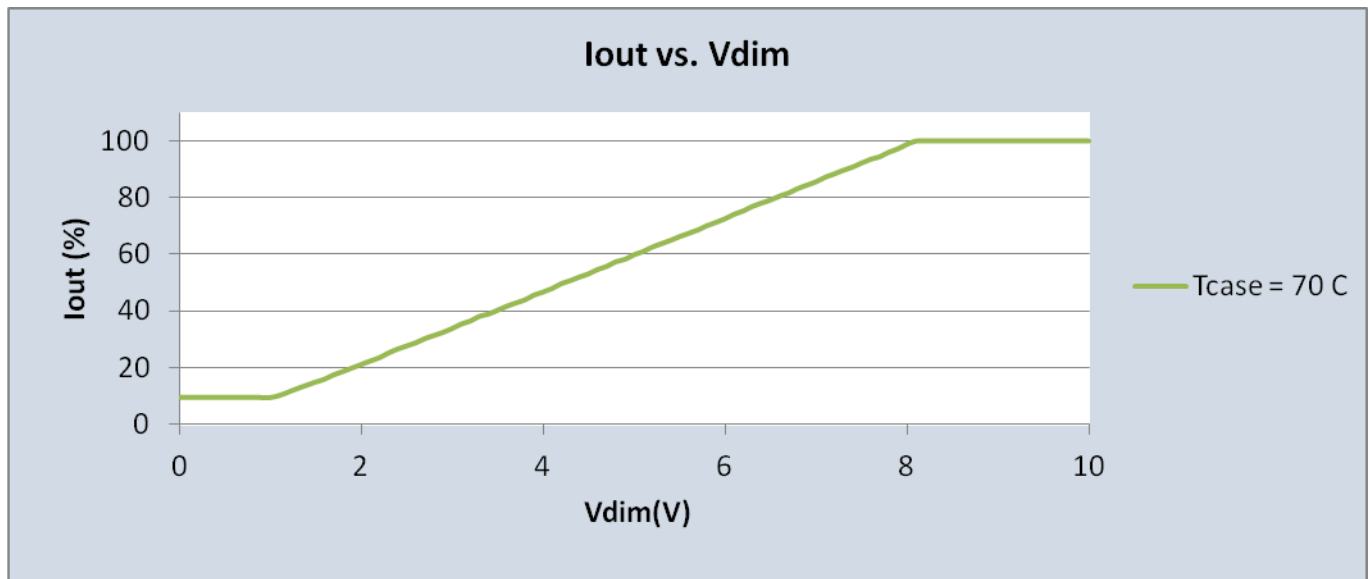

Revised 04/05/2012

### **PHILIPS LIGHTING ELECTRONICS N.A.**

10275 WEST HIGGINS ROAD · ROSEMONT, IL 60018

Tel: 800-322-2086 · Fax: 888-423-1882 · [www.philips.com/advance](http://www.philips.com/advance)

Customer Support/Technical Service: 800-372-3331 · OEM Support: 866-915-5886



<b>9290 007 05113</b>	
Brand Name	XITANIUM
Description	Xitanium 150W .35-.7A GL Prog+ sXt
Input Voltage	120~200~240~277
Input Frequency	50/60Hz
RoHS	Yes
Status	Active

## Electrical Specifications

### Amp Dimming Curve:

Parameter	Min	Max	Increments
Start Voltage	170V	250V	1V (configurable by software)
Stop Voltage	150V	230V	1V (configurable by software)
Start Percent	30%	100%	1% (configurable by software)
Stop Percent	30%	100%	1% (configurable by software)

$$\text{Current Tolerance: } \Delta I(\%) = \frac{\text{Start Percent} - \text{Stop Percent}}{\text{Start Voltage} - \text{Stop Voltage}} \times 5$$

Fade Time: 2s (+/- 10%)

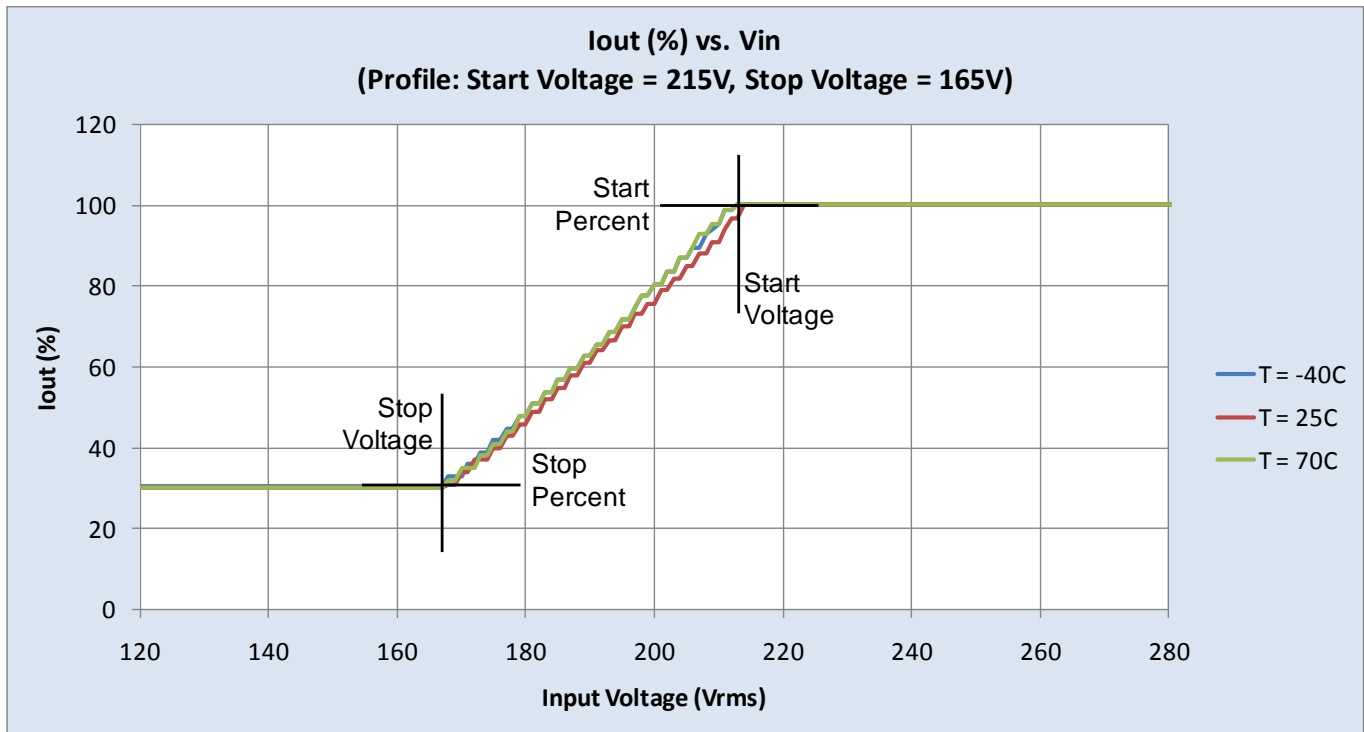

Revised 04/05/2012

**PHILIPS LIGHTING ELECTRONICS N.A.**  
10275 WEST HIGGINS ROAD · ROSEMONT, IL 60018  
Tel: 800-322-2086 · Fax: 888-423-1882 · [www.philips.com/advance](http://www.philips.com/advance)  
Customer Support/Technical Service: 800-372-3331 · OEM Support: 866-915-5886

**9290 007 05113**

Brand Name	XITANIUM
Description	Xitanium 150W .35-.7A GL Prog+ sXt
Input Voltage	120~200~240~277
Input Frequency	50/60Hz
RoHS	Yes
Status	Active

## Electrical Specifications

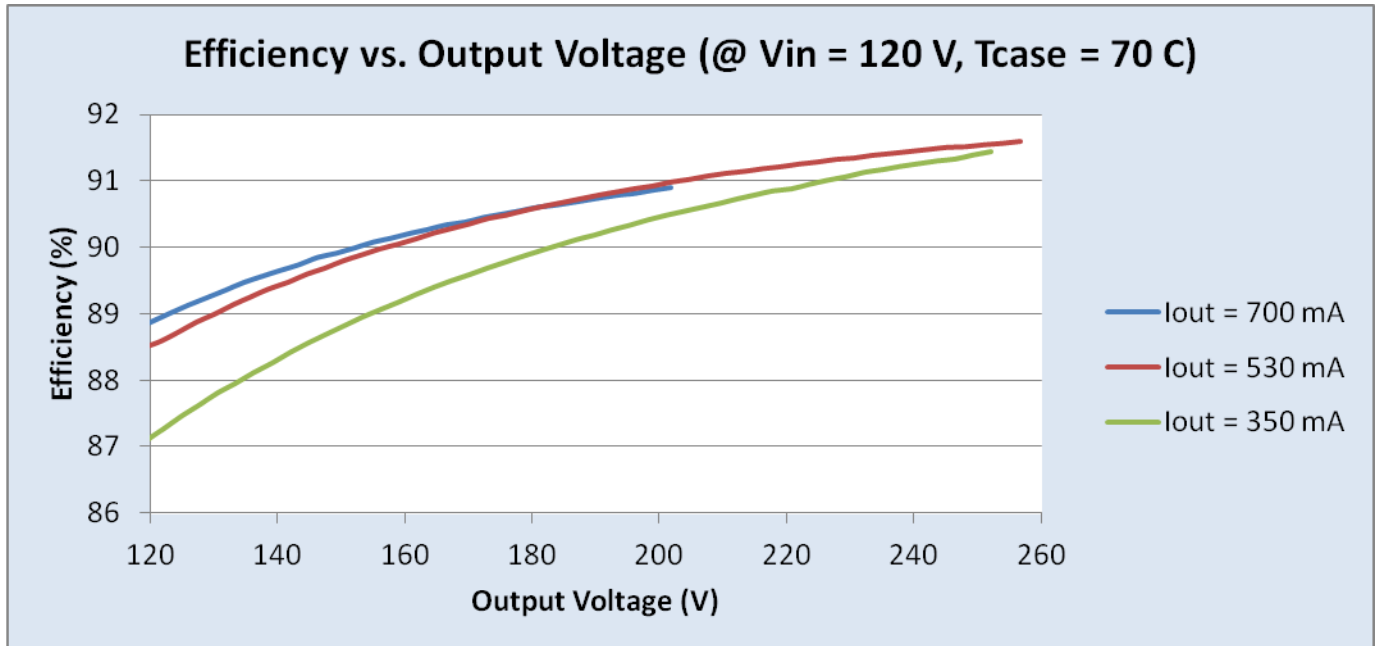

Revised 04/05/2012





<b>9290 007 05113</b>	
Brand Name	XITANIUM
Description	Xitanium 150W .35-.7A GL Prog+ sXt
Input Voltage	120~200~240~277
Input Frequency	50/60Hz
RoHS	Yes
Status	Active

### Electrical Specifications

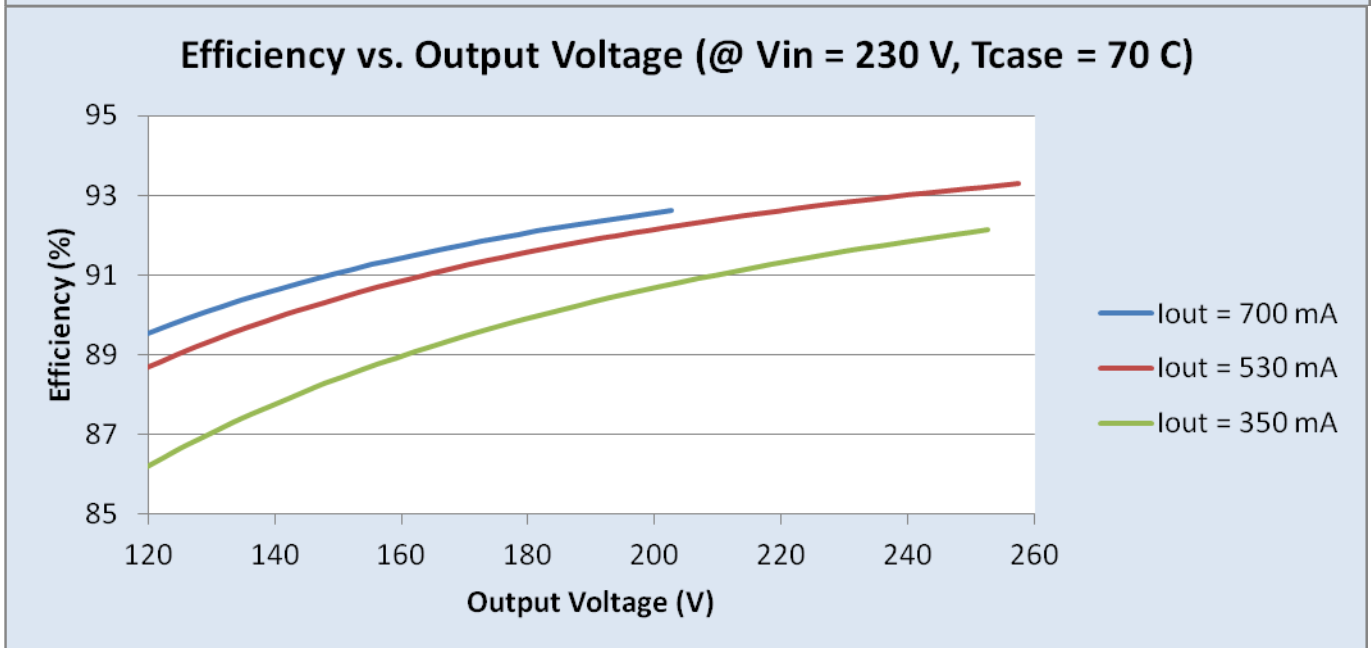
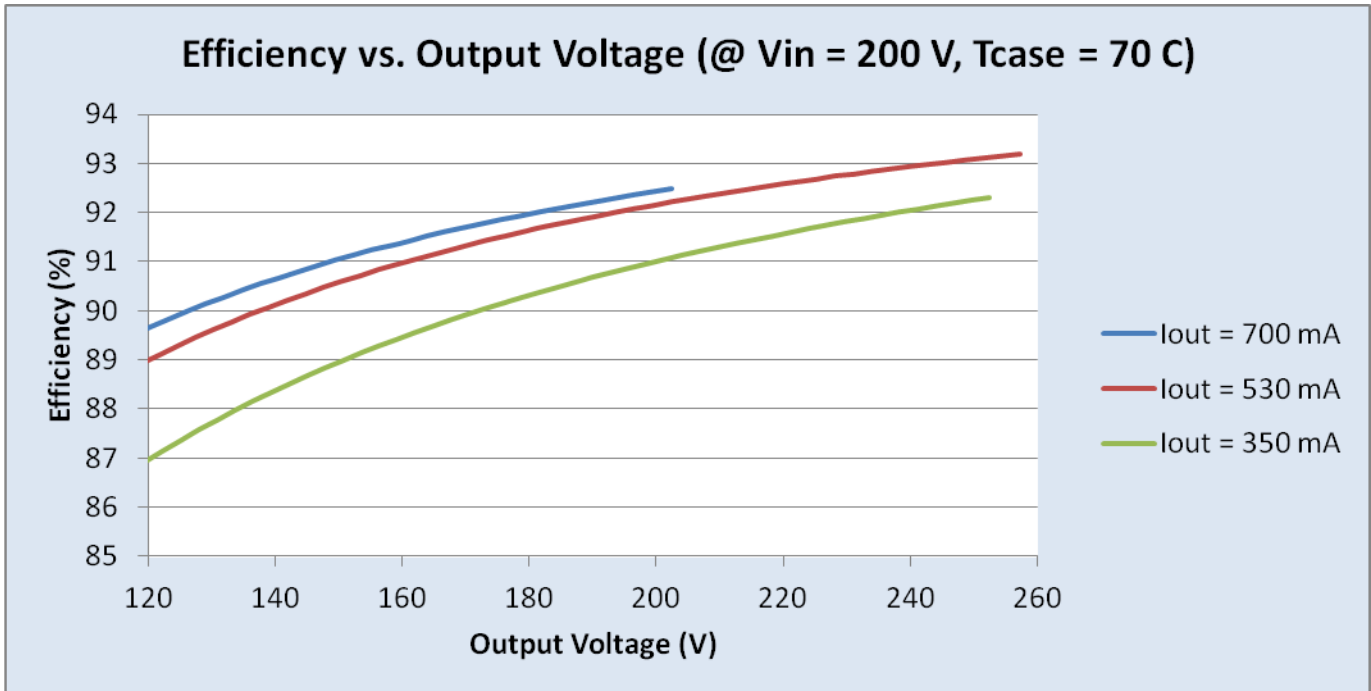

Revised 04/05/2012

<b>9290 007 05113</b>	
Brand Name	XITANIUM
Description	Xitanium 150W .35-.7A GL Prog+ sXt
Input Voltage	120~200~240~277
Input Frequency	50/60Hz
RoHS	Yes
Status	Active

## Electrical Specifications

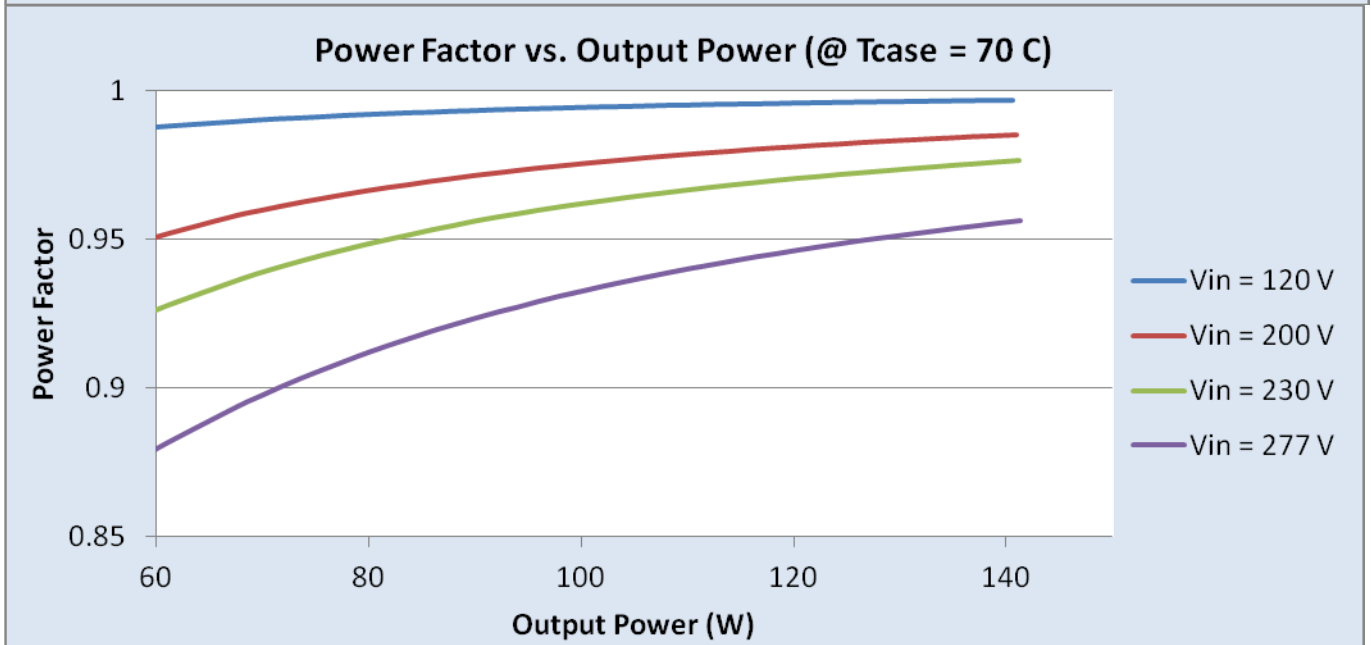
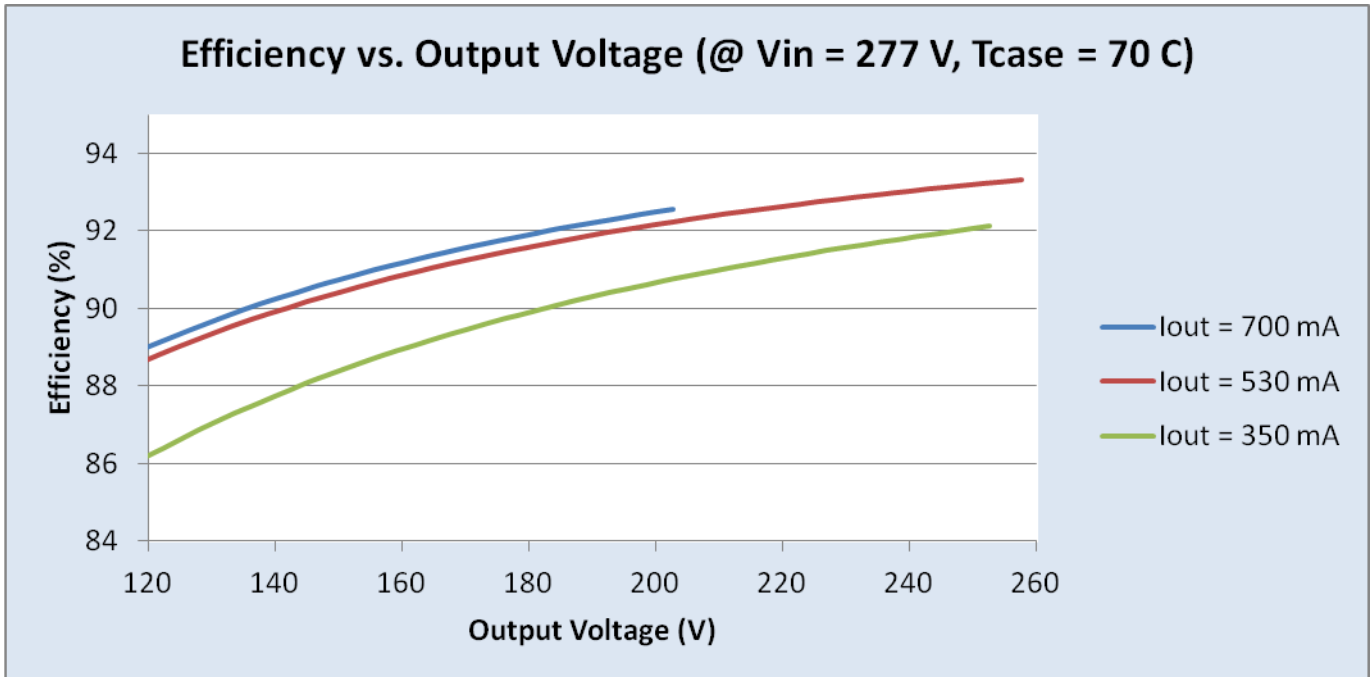

Revised 04/05/2012



**9290 007 05113**

Brand Name	XITANIUM
Description	Xitanium 150W .35-.7A GL Prog+ sXt
Input Voltage	120~200~240~277
Input Frequency	50/60Hz
RoHS	Yes
Status	Active

Electrical Specifications

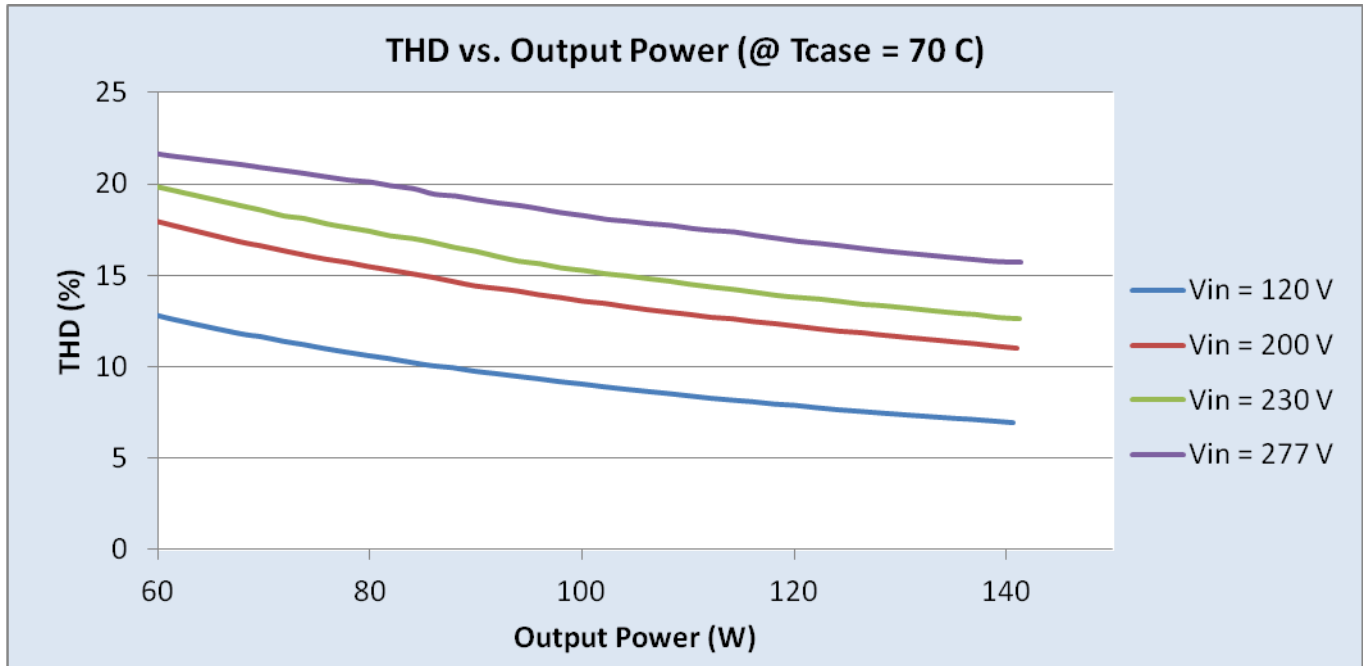

Revised 04/05/2012

**PHILIPS LIGHTING ELECTRONICS N.A.**  
10275 WEST HIGGINS ROAD · ROSEMONT, IL 60018  
Tel: 800-322-2086 · Fax: 888-423-1882 · [www.philips.com/advance](http://www.philips.com/advance)  
Customer Support/Technical Service: 800-372-3331 · OEM Support: 866-915-5886



<b>9290 007 05113</b>	
Brand Name	XITANIUM
Description	Xitanium 150W .35-.7A GL Prog+ sXt
Input Voltage	120~200~240~277
Input Frequency	50/60Hz
RoHS	Yes
Status	Active

## Electrical Specifications

### Programming Interface:

**Adjustable Output Current (ADC)**

Module current  mA

Use external RSET

**Module Temperature Protection (MTP)**

Disable MTP

NTC2:15k+390ohms

MTP warn  C

MTP max  C

MTP min dim level  %

**Adjustable Startup Time (AST)**

Start fadeup time  ms

**Over The Life (OTL)**

Disable OTL

OTL activation time  hrs

Set Module working hrs  hrs

**Dimming Interface Selection (DIS)**

1 - 10V

DALI

Integrated Dynadimmer

AmpDim

No dimming

AmpDim Start Voltage  V

AmpDim Start Percent  %

AmpDim Stop Voltage  V

AmpDim Stop Percent  %

**Constant Light Output (CLO)**

Disable CLO  Enable CLO

100	101	103	104	105	107	109	112	115	116	117	118	119	120	120	120	%
0	4000	8000	12000	16000	20000	24000	28000	32000	36000	40000	44000	48000	52000	60000	100000	Hrs

Port Setup **COM 1 Active**

Notes

### Programming Tool:

Refer to Website for downloading tool.

Revised 04/05/2012

**PHILIPS LIGHTING ELECTRONICS N.A.**  
10275 WEST HIGGINS ROAD · ROSEMONT, IL 60018  
Tel: 800-322-2086 · Fax: 888-423-1882 · [www.philips.com/advance](http://www.philips.com/advance)  
Customer Support/Technical Service: 800-372-3331 · OEM Support: 866-915-5886

<b>9290 007 05113</b>	
Brand Name	XITANIUM
Description	Xitanium 150W .35-.7A GL Prog+ sXt
Input Voltage	120~200~240~277
Input Frequency	50/60Hz
RoHS	Yes
Status	Active

## Electrical Specifications

### Iout vs. Tcase of Driver:

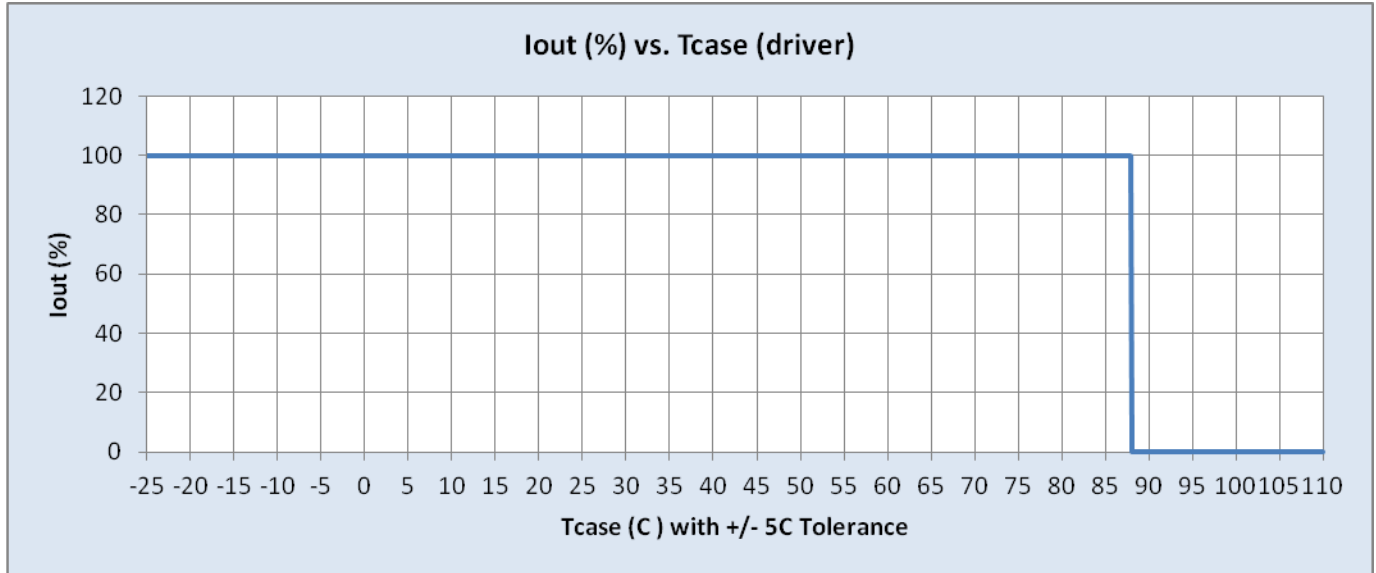

### Inrush Current Info:

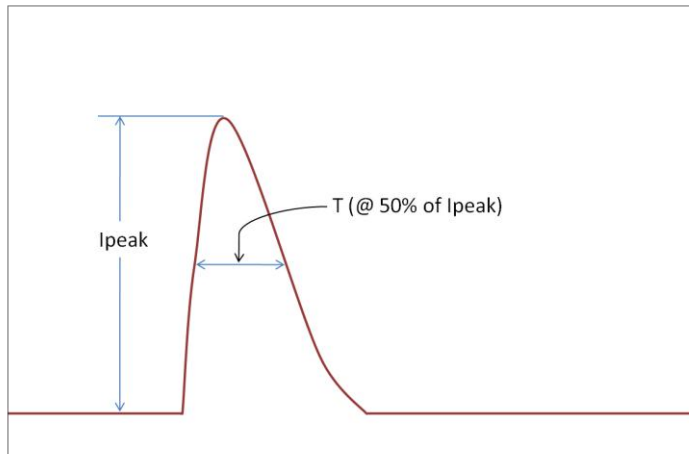

Vin	Ipeak	T (@ 50% of Ipeak)
120 Vrms	58 A	140 $\mu$ s
230 Vrms	108 A	140 $\mu$ s
277 Vrms	126 A	140 $\mu$ s
305 Vrms	142 A	140 $\mu$ s

Revised 04/05/2012



<b>9290 007 05113</b>	
Brand Name	XITANIUM
Description	Xitanium 150W .35-.7A GL Prog+ sXt
Input Voltage	120~200~240~277
Input Frequency	50/60Hz
RoHS	Yes
Status	Active

Electrical Specifications

**Lifetime vs. Tcase of Driver:**

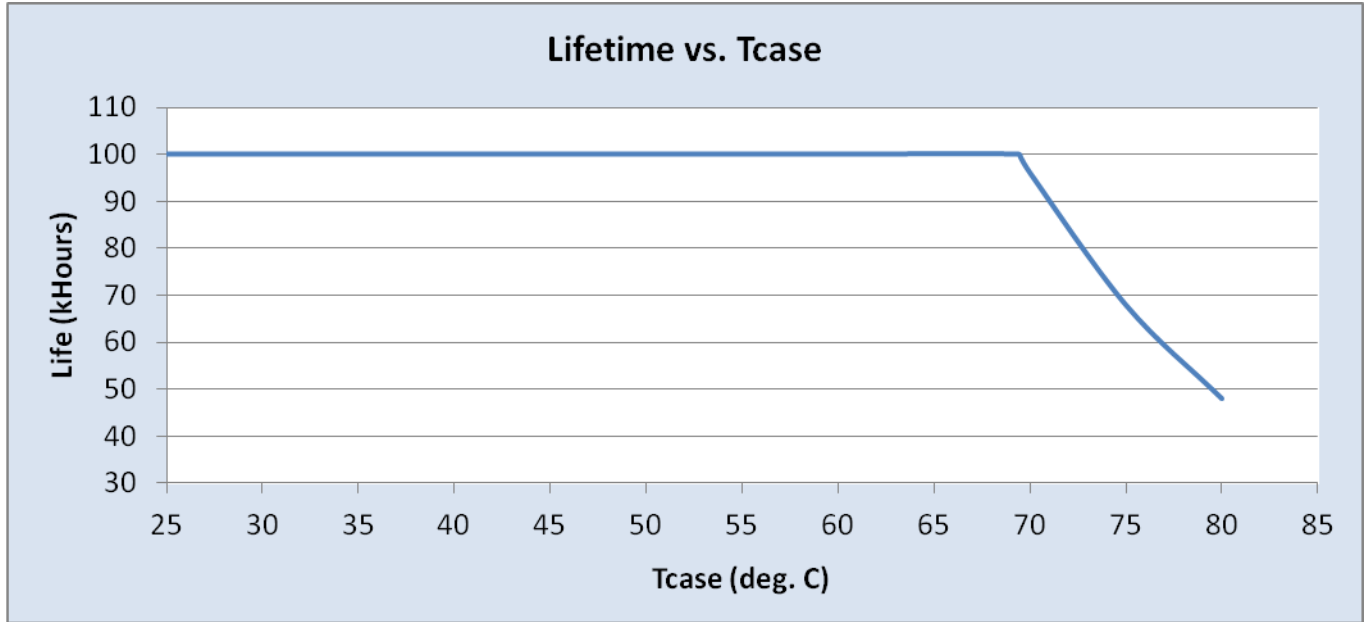

**Failure Rate Info:** <0.01% per 1 kHr @<= Tcase 80 C

**Isolation:**

Isolation	Input Wires	Output Wires	DALI Wires	1-10V Wires	Chassis
Input Wires	NA	1750	1750	1750	3750
Output Wires+ Fortimo Interface Wires	1750	NA	1750	1750	3750
DALI Wires	1750	1750	NA	NA	3750
1-10V Wires	1750	1750	NA	NA	3750
Chassis	3750	3750	3750	3750	NA

Revised 04/05/2012



<b>9290 007 05113</b>	
Brand Name	XITANIUM
Description	Xitanium 150W .35-.7A GL Prog+ sXt
Input Voltage	120~200~240~277
Input Frequency	50/60Hz
RoHS	Yes
Status	Active

## Electrical Specifications

### Revision History:

<u>Rev No.</u>	<u>Date</u>	<u>Description</u>	<u>Approval</u>	<u>Remarks</u>
1.1	11/17/2011	* Remove graph "Failure rate vs. Tcase	N.T.	
1.2	04/04/2012	* Add Envir. Protection Rating	N.T.	
1.3	04/04/2012	* Add Cycling Temperature to Product Data Table	N.T.	
1.4	04/05/2012	*Remove the "M" in the part#	N.T.	

Revised 04/05/2012

**PHILIPS LIGHTING ELECTRONICS N.A.**  
10275 WEST HIGGINS ROAD · ROSEMONT, IL 60018  
Tel: 800-322-2086 · Fax: 888-423-1882 · [www.philips.com/advance](http://www.philips.com/advance)  
Customer Support/Technical Service: 800-372-3331 · OEM Support: 866-915-5886