

PHILIPS

XI050C100V054XPL1

Electrical Specifications

Brand Name	XITANIUM
Description	Xitanium 50W 0.3-1A 0-10V/TE
Input Voltage	120~277V
Input Frequency	50/60Hz
RoHS	Yes
Status	Active

Output Power (W)	Output Voltage (V)	Output Current (A)	Efficiency@ Max Load		Max Case Temp. (°C)	Input Current				Max. Input Power (W)	Inrush Current (A _{in} /50%-µs)		THD @ Max Load (%)	Power Factor @ Max Load 120/277V _a _c	Weight (Lbs/kgs)	Envir. Protection Rating
			120 V	277 V		120					277	120 Vin				
50	27 - 54	0.3 - 1	86	89	75 °C	0.5				277	60	2.8 / 700	20	>0.9	0.25	UL Dry & Damp

Wire Diagram

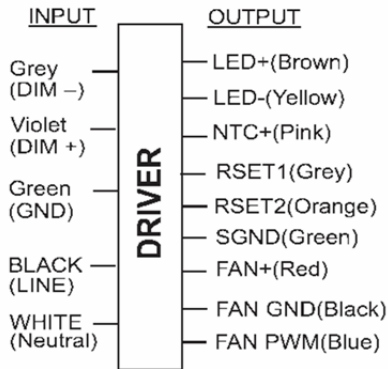

Input and output use lead- wires 16 - 20AWG solid copper.
Advice strip length 0.35 inch.

Dimming Method	Dimming Range	Minimum Output Current (A)	Other Comments
1-10V Isolated	10% ~ 100%	0.030	@120V Only
Phase cut	10% ~ 100%	0.030	



Enclosure

	in. (mm)
Case Length	5.6 (142.5)
Case Width	1.7 (43.0)
Case Height	1.2 (30.0)
Mounting Length	6..1 (154)
Mounting Width	1.7 (43.0)
Overall Length	6.5 (166)



Revised 10/01/2012

PHILIPS LIGHTING ELECTRONICS N.A.

10275 WEST HIGGINS ROAD · ROSEMONT, IL 60018
Tel: 800-322-2086 · Fax: 888-423-1882 · www.philips.com/advance
Customer Support/Technical Service: 800-372-3331 · OEM Support: 866-915-5886



XI050C100V054XPL1

Brand Name	XITANIUM
Description	Xitanium 50W 0.3-1A 0-10V/TE
Input Voltage	120~277V
Input Frequency	50/60Hz
RoHS	Yes
Status	Active

Electrical Specifications

Product Data

Order code	XI050C100V054XPL1
Full product code	XI050C100V054XPL1
Full product name	Xitanium 50W 0.3- 1A 54V 0-10V/TE Dimming
Net weight per piece	0.25 KG
Interfaces	1-10V / TE Dimming, AOC,CLO, OTL
Ambient Temp Range	-20C to +50C
Corresponding Tcase	-15C to +75C
Line Voltage	120-277V
Line Current	0.5A @ 120V, 0.2@ 277V
Line Frequency	60Hz
Envir. Protection Rating	UL Dry & Damp
EMI	FCC47 Class B
Life @ TC 75 C	50000 hr [nom.]
Suitable for Outdoor use?	No
Max TC	75C
Inrush current Width	Refer to table
Maximum ballast number on MCB 16A	60@120V / 26@277V
Input Over-voltage	Can survive input over-voltage stress of 320VAC for 48 hours and 350VAC for 2 hours
LED Current Tolerance	+/-5%
Earth leakage current	0.7 mA [max]
Mains voltage safety (AC)	+/-10%
Mains voltage performance (AC)	+/-10%
Min. Mains voltage operational	108V [min]
Output peak voltage	305V [max]
Output Current ripple	20% @ 1000 mA (ripple = pk-pk/avg)
THD total	< 20%
PF @ Max Load	>0.9
Connector (input/output)	Wago 250
Protections	Short Circuit and Open Circuit Protection for LED + and LED-

Revised 10/01/2012

PHILIPS LIGHTING ELECTRONICS N.A.

10275 WEST HIGGINS ROAD · ROSEMONT, IL 60018
 Tel: 800-322-2086 · Fax: 888-423-1882 · www.philips.com/advance
 Customer Support/Technical Service: 800-372-3331 · OEM Support: 866-915-5886

XI050C100V054XPL1	
Brand Name	XITANIUM
Description	Xitanium 50W 0.3-1A 0-10V/TE
Input Voltage	120~277V
Input Frequency	50/60Hz
RoHS	Yes
Status	Active

Electrical Specifications

Installation & Application Notes:

Section I – Physical Characteristics

- 1.1 LED Driver shall be installed inside an electrical enclosure
- 1.2 Wiring inside electrical enclosure shall comply with 300V/105°C rating or higher.

Section II – Performance

- 2.1 LED Driver has a rated lifetime of 50,000 hours @ TC ≤75°C.
- 2.2 LED Driver tolerates sustained open circuit and short circuit output conditions without damage.
- 2.3 LED Driver maximum allowable case temperature is 75°C – see product label for measurement location.
- 2.4 LED Driver can reduce output power to LEDs if NTC to monitor LED temperature is in place.
- 2.5 LED Driver complies with the requirements of UL, CSA, FCC.
- 2.6 LED Driver complies with the requirements of UL, CSA, FCC47 Class B.

Section III – UL Conditions of Acceptability (File E321253)

When installed in the end product, consideration shall be given to the following:

- 3.1 The maximum available output parameters of the driver met the limitation for Class 2 Inherently limited as specified Table 30.1 of the UL 1310 standard for Class 2 Power Units.
- 3.2 Primary wiring to be 18-AWG-Solid-Copper wire, rated 300V minimum, 105°. Strip wire 3/8 in prior to inserting into primary terminal blocks.
- 3.3 The primary and secondary terminal blocks are R/C (XCFR2/8) suitable for field wiring.
- 3.4 The LED Driver is suitable for use in “Dry” and “Damp” Locations.
- 3.5 The driver enclosure temperature in the end-use application should not exceed 75°C at the (Tc) location specified on the marking label.
- 3.6 The enclosure must be connected to earth ground in the end-use application.
- 3.7 The need for a leakage current test must be determined in the end-use product. The maximum measured and recorded leakage current using leakage current tester by Simpson model 228 was 0.14 mA.
- 3.8 The output designated “Fan Output” is isolated and the maximum available parameters met the limits for LVLE circuit.
- 3.9 The maximum available output parameters from the (0-10 V) dimming circuit provided meets class 2 limits.

Model No.	Input Voltage, Hz	Max. Case @ Tc, °C
XI050C100V054XPL1	120V, 60 Hz	75

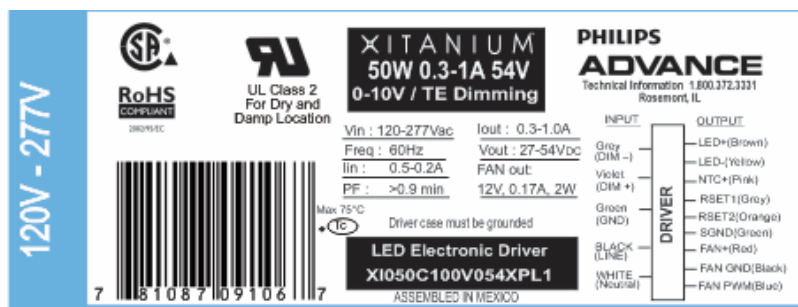

Revised 10/01/2012

PHILIPS LIGHTING ELECTRONICS N.A.
 10275 WEST HIGGINS ROAD · ROSEMONT, IL 60018
 Tel: 800-322-2086 · Fax: 888-423-1882 · www.philips.com/advance
 Customer Support/Technical Service: 800-372-3331 · OEM Support: 866-915-5886

XI050C100V054XPL1	
Brand Name	XITANIUM
Description	Xitanium 50W 0.3-1A 0-10V/TE
Input Voltage	120~277V
Input Frequency	50/60Hz
RoHS	Yes
Status	Active

Electrical Specifications

AOC (Adjustable Output Current) Settings:

LED current tolerance with variation of Rset 1 is within +/- 5% of Imax

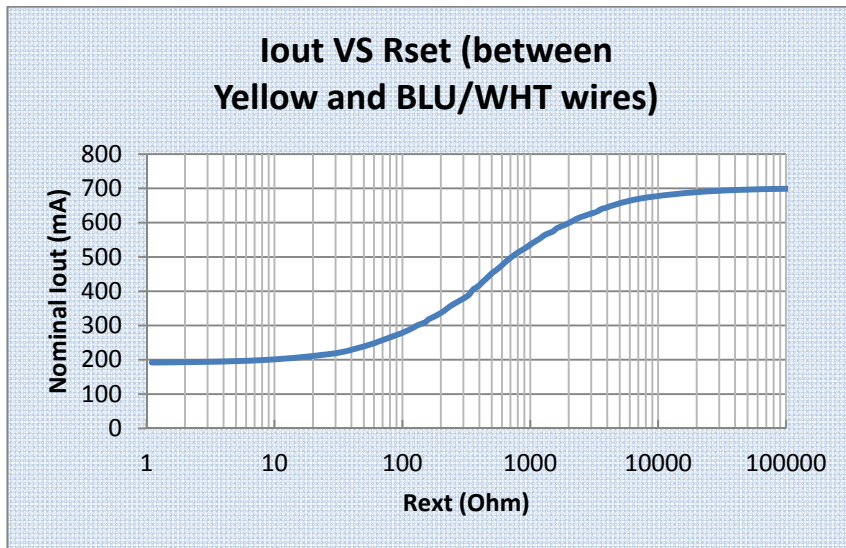

1.1 Rset2 Table

(Valid Range of Current 0.3-1.0A)

Rset1 (Ohms)	Current(mA)
1	191
100	214
620	309
910	347
935	350
1500	406
2200	455
3000	494
4115	530
4300	536
8200	599
18000	649
100000	691
1000000	700

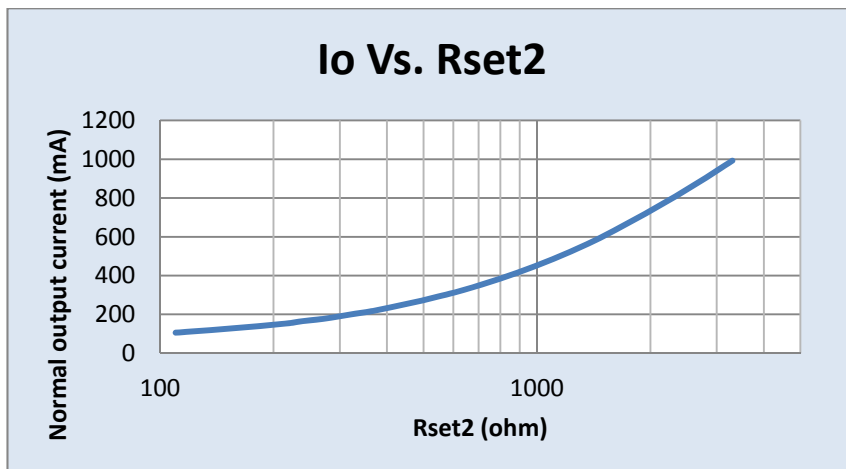

Rset2 (Ohms)	Current(mA)
100	100
270	176.4368
360	214.6552
470	261.0632
560	296.5517
750	367.5287
1000	452.1552
1300	544.9713
1500	602.2989
1800	684.1954
2700	883.477
3300	992.6724

Revised 10/01/2012

PHILIPS LIGHTING ELECTRONICS N.A.

10275 WEST HIGGINS ROAD · ROSEMONT, IL 60018

Tel: 800-322-2086 · Fax: 888-423-1882 · www.philips.com/advance

Customer Support/Technical Service: 800-372-3331 · OEM Support: 866-915-5886

XI050C100V054XPL1	
Brand Name	XITANIUM
Description	Xitanium 50W 0.3-1A 0-10V/TE
Input Voltage	120~277V
Input Frequency	50/60Hz
RoHS	Yes
Status	Active

Revised 10/01/2012

PHILIPS LIGHTING ELECTRONICS N.A.
 10275 WEST HIGGINS ROAD · ROSEMONT, IL 60018
 Tel: 800-322-2086 · Fax: 888-423-1882 · www.philips.com/advance
 Customer Support/TechnicaA Service 800-372-3331 · OEM Support: 866-915-5886



XI050C100V054XPL1	
Brand Name	XITANIUM
Description	Xitanium 50W 0.3-1A 0-10V/TE
Input Voltage	120~277V
Input Frequency	50/60Hz
RoHS	Yes
Status	Active

Electrical Specifications

1-10V Dimming Curve:

Vmains= 120V/60Hz

I_out = 1000mA

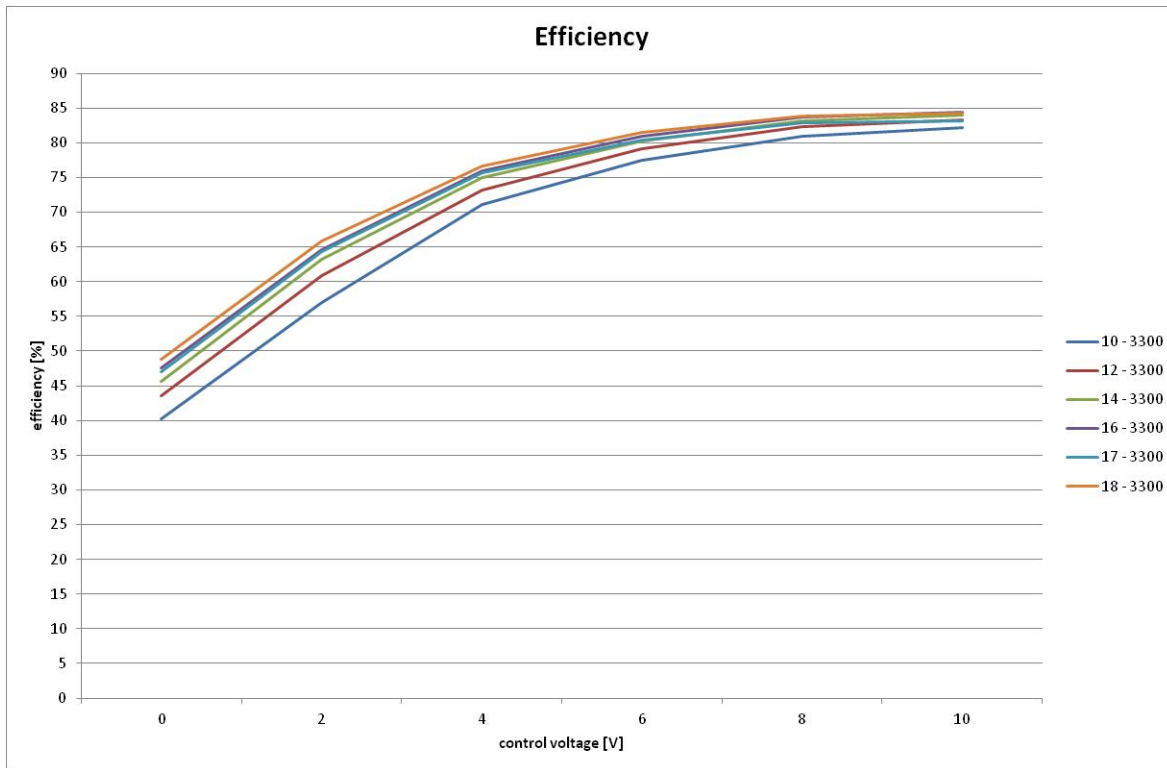

Rset2 =
3300 Ω

Legend displays the amount of LEDs in the load and the value of Rset2

Revised 10/01/2012

PHILIPS LIGHTING ELECTRONICS N.A.
10275 WEST HIGGINS ROAD · ROSEMONT, IL 60018
Tel: 800-322-2086 · Fax: 888-423-1882 · www.philips.com/advance
Customer Support/Technical Service: 800-372-3331 · OEM Support: 866-915-5886

XI050C100V054XPL1

Brand Name	XITANIUM
Description	Xitanium 50W 0.3-1A 0-10V/TE
Input Voltage	120~277V
Input Frequency	50/60Hz
RoHS	Yes
Status	Active

Electrical Specifications

Power factor vs. control voltage @ various LEDs

Vmains= 120V/60Hz

I_{out} = 700mA

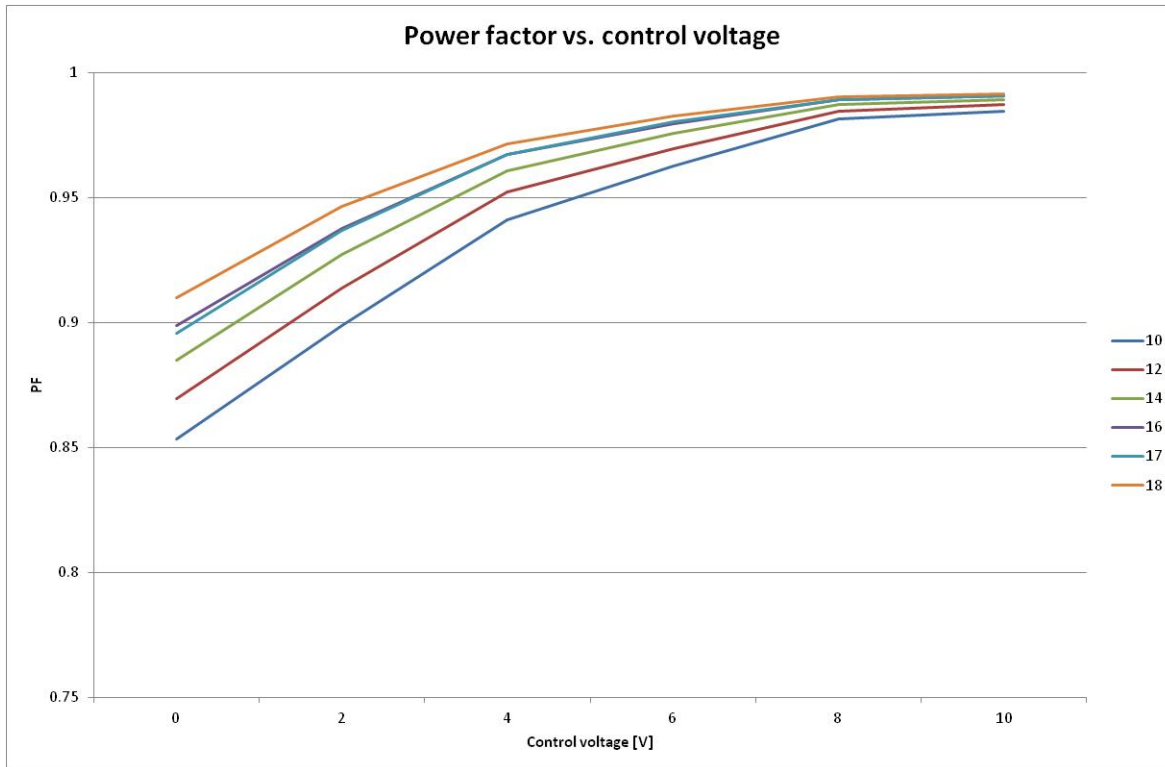

Legend displays the amount of LEDs in the load

Revised 10/01/2012



XI050C100V054XPL1

Brand Name	XITANIUM
Description	Xitanium 50W 0.3-1A 0-10V/TE
Input Voltage	120~277V
Input Frequency	50/60Hz
RoHS	Yes
Status	Active

Electrical Specifications

Output voltage vs. control voltage @ various LEDs

V_{mains} = 120V/60Hz

I_{out} = 700mA

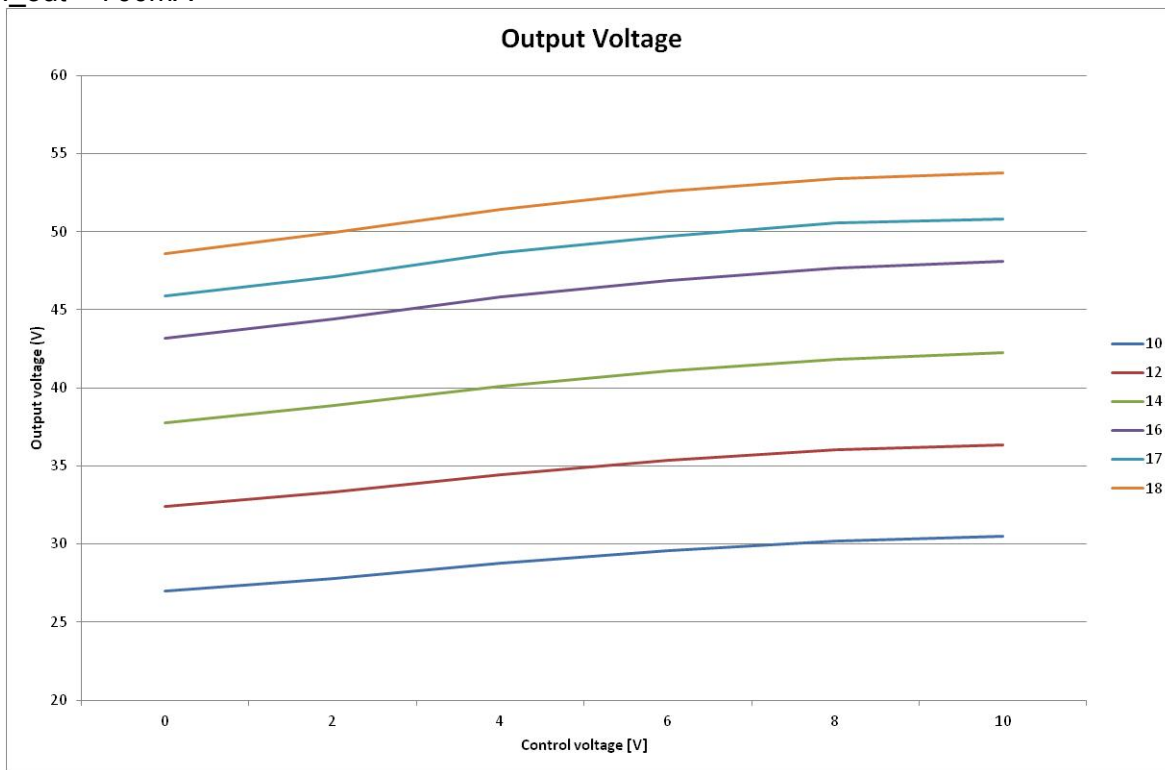

Legend displays the amount of LEDs in the load

Revised 10/01/2012

PHILIPS LIGHTING ELECTRONICS N.A.
10275 WEST HIGGINS ROAD · ROSEMONT, IL 60018
Tel: 800-322-2086 · Fax: 888-423-1882 · www.philips.com/advance
Customer Support/Technical Service: 800-372-3331 · OEM Support: 866-915-5886



XI050C100V054XPL1	
Brand Name	XITANIUM
Description	Xitanium 50W 0.3-1A 0-10V/TE
Input Voltage	120~277V
Input Frequency	50/60Hz
RoHS	Yes
Status	Active

Electrical Specifications

Output current vs. dim level vs. Rset2 @ Vmains =120V.

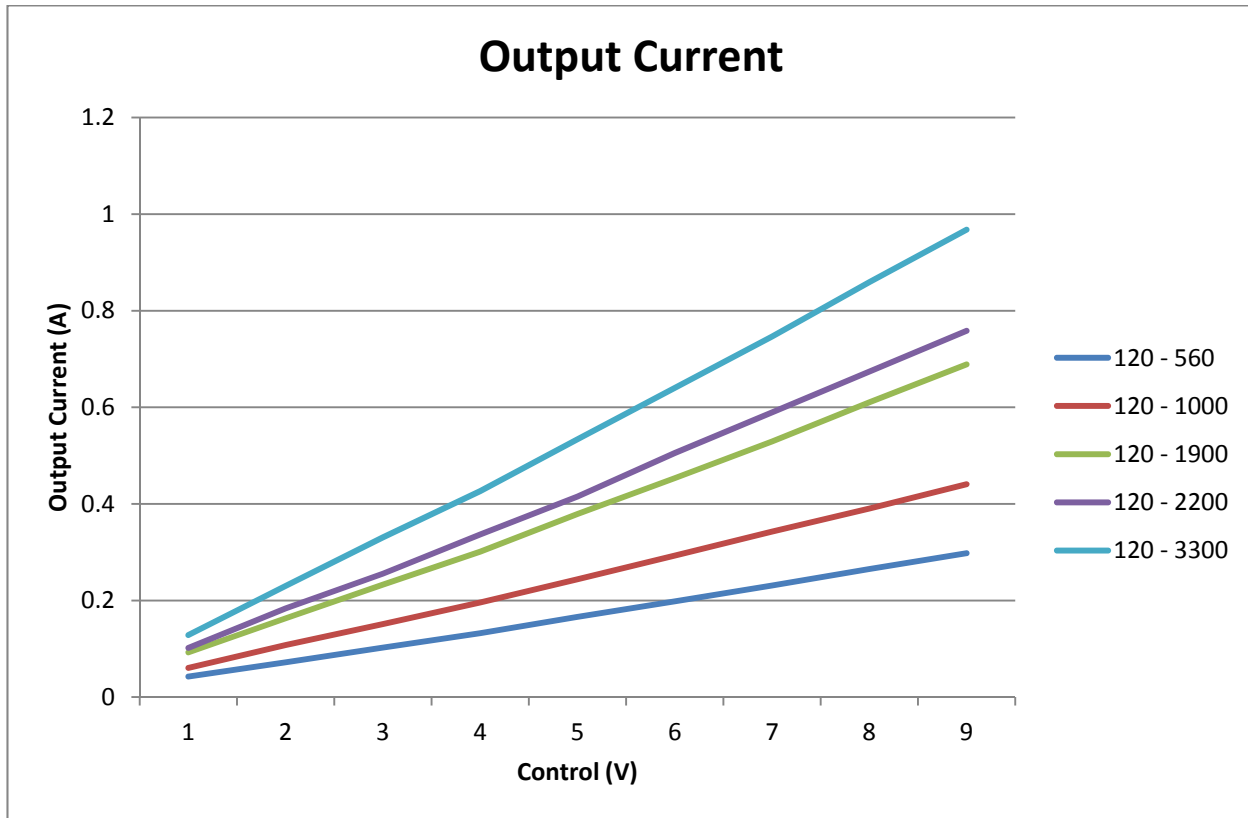

Revised 10/01/2012

PHILIPS LIGHTING ELECTRONICS N.A.
10275 WEST HIGGINS ROAD · ROSEMONT, IL 60018
Tel: 800-322-2086 · Fax: 888-423-1882 · www.philips.com/advance
Customer Support/Technical Service: 800-372-3331 · OEM Support: 866-915-5886



XI050C100V054XPL1	
Brand Name	XITANIUM
Description	Xitanium 50W 0.3-1A 0-10V/TE
Input Voltage	120~277V
Input Frequency	50/60Hz
RoHS	Yes
Status	Active

Electrical Specifications

Output power vs. control voltage @ various LEDs @ various Rset2

Vmains= 120V/60Hz

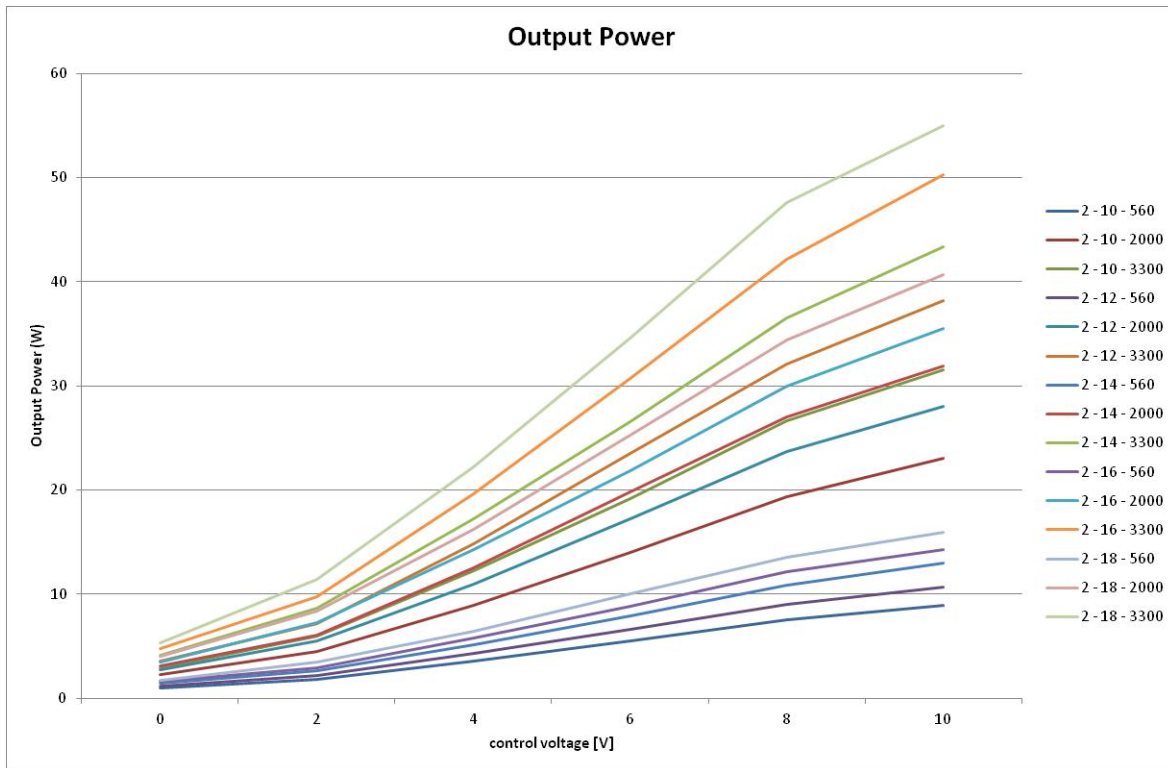

Legend displays the amount of LEDs in the load and the value of Rset2

Revised 10/01/2012

PHILIPS LIGHTING ELECTRONICS N.A.
10275 WEST HIGGINS ROAD · ROSEMONT, IL 60018
Tel: 800-322-2086 · Fax: 888-423-1882 · www.philips.com/advance
Customer Support/Technical Service: 800-372-3331 · OEM Support: 866-915-5886



XI050C100V054XPL1	
Brand Name	XITANIUM
Description	Xitanium 50W 0.3-1A 0-10V/TE
Input Voltage	120~277V
Input Frequency	50/60Hz
RoHS	Yes
Status	Active

Electrical Specifications

Input current vs. Rset2

Vmains = 120V @ various control voltages

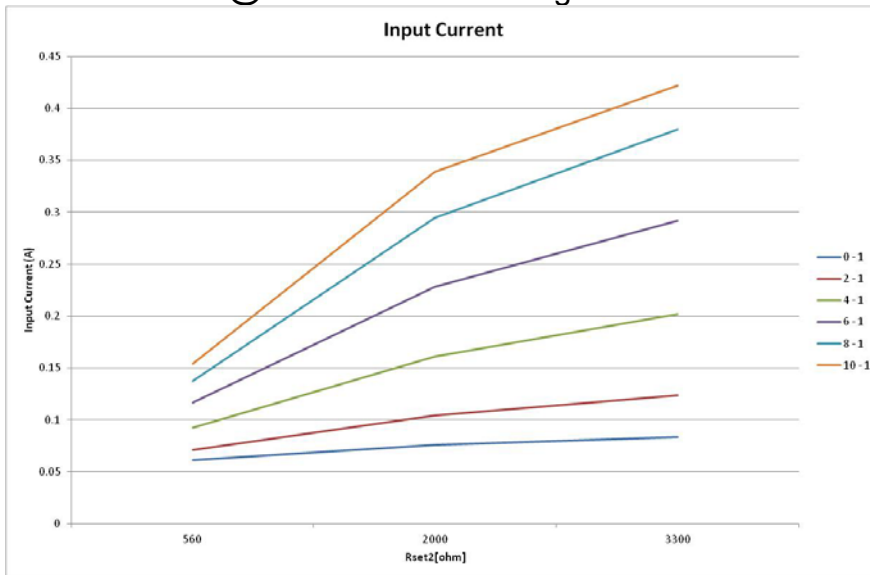

Revised 10/01/2012

PHILIPS LIGHTING ELECTRONICS N.A.
10275 WEST HIGGINS ROAD · ROSEMONT, IL 60018
Tel: 800-322-2086 · Fax: 888-423-1882 · www.philips.com/advance
Customer Support/Technical Service: 800-372-3331 · OEM Support: 866-915-5886

XI050C100V054XPL1

Brand Name	XITANIUM
Description	Xitanium 50W 0.3-1A 0-10V/TE
Input Voltage	120~277V
Input Frequency	50/60Hz
RoHS	Yes
Status	Active

Electrical Specifications

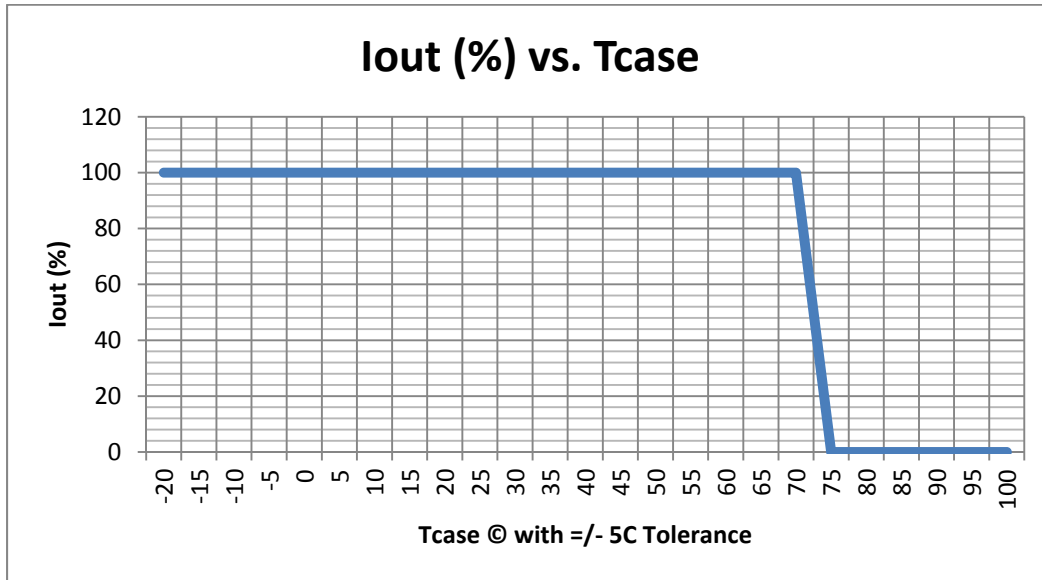

Inrush Current Info:

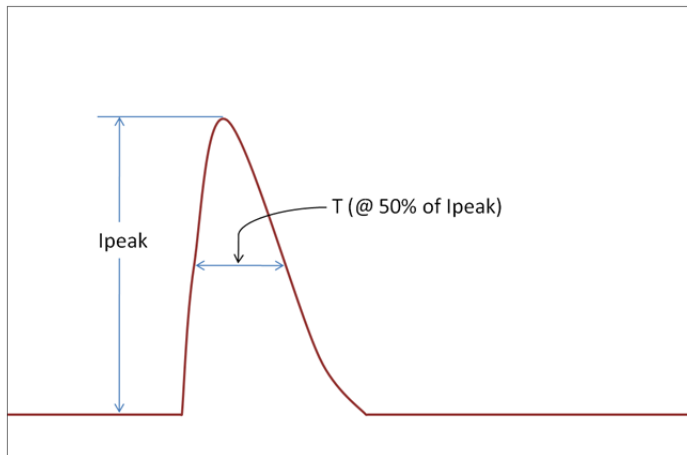

Vin	Ipeak	T (@ 50% of Ipeak)
120 Vrms	2.8 A	700 μ s
277 Vrms	7.4 A	600 μ s

Revised 10/01/2012

PHILIPS LIGHTING ELECTRONICS N.A.

10275 WEST HIGGINS ROAD · ROSEMONT, IL 60018
 Tel: 800-322-2086 · Fax: 888-423-1882 · www.philips.com/advance
 Customer Support/Technical Service: 800-372-3331 · OEM Support: 866-915-5886



XI050C100V054XPL1

Brand Name	XITANIUM
Description	Xitanium 50W 0.3-1A 0-10V/TE
Input Voltage	120~277V
Input Frequency	50/60Hz
RoHS	Yes
Status	Active

Electrical Specifications

Lifetime vs. Tcase of Driver:

Failure Rate Info:

1. <math><0.2\%</math> per 1 kHr @

Driver Isolation between:

Isolation	Input Wires	Output Wires	1-10V Wires	Chassis
Input Wires	NA	1600	1600	1600
Output Wires	1600	NA	1600	1600
1-10V Wires	1600	1600	NA	1600
Chassis	1600	1600	1600	NA

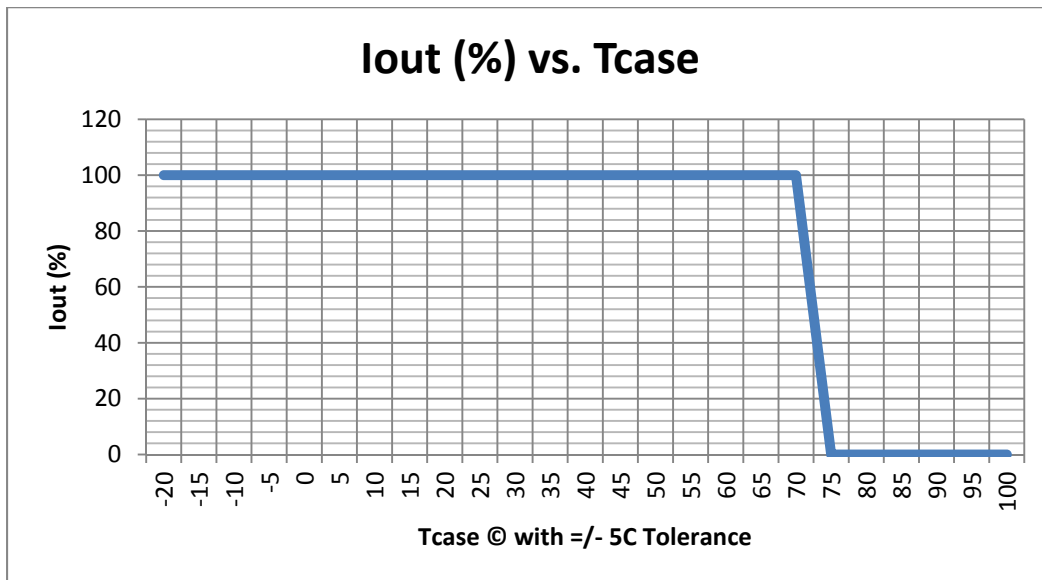

Revised 10/01/2012

PHILIPS LIGHTING ELECTRONICS N.A.

10275 WEST HIGGINS ROAD · ROSEMONT, IL 60018

Tel: 800-322-2086 · Fax: 888-423-1882 · www.philips.com/advance

Customer Support/Technical Service: 800-372-3331 · OEM Support: 866-915-5886



XI050C100V054XPL1

Brand Name	XITANIUM
Description	Xitanium 50W 0.3-1A 0-10V/TE
Input Voltage	120~277V
Input Frequency	50/60Hz
RoHS	Yes
Status	Active

Electrical Specifications

Dimmer compatibility list:	Lutron DVELV-303P (ELV 3-way)
	Lutron SELV-300P
	Leviton IPEO4-1LX
	Lightolier ZP260QE (ELV 3-way)
	Leviton VZE06-1LZ (ELV 3-way)
	Lightolier ZP425QE

Revision History:

Rev No.	Date	Description	Approval	Remarks
1.1	1/26/2012	*Remove graph "Failure rate vs. Tcase	N.T.	
1.2	1/26/2012	* Add Envir. Protection Rating	N.T.	
1.3	1/26/2012	* Add Section 1-2.6 EMI Rating	N.T.	
1.4	03/02/2012	*Remove the "M" at the end of part#	N.T.	
1.5	04/02/2012	*Add Rset2 Table and Graphs ("Iout VS Rset" & "Io Vs. Rset2")	N.T.	

Revised 10/01/2012

PHILIPS LIGHTING ELECTRONICS N.A.

10275 WEST HIGGINS ROAD · ROSEMONT, IL 60018
Tel: 800-322-2086 · Fax: 888-423-1882 · www.philips.com/advance
Customer Support/Technical Service: 800-372-3331 · OEM Support: 866-915-5886