

9290 007 10103

Brand Name	XITANIUM
Description	Xitanium 75W 0.70A Prog+ GL-Z sXt
Input Voltage	120 ~ 230 ~ 277V
Input Frequency	50/60Hz
RoHS	Yes
Status	Preliminary

Electrical Specifications

Output Power (W)	Output Voltage (V)	Output Current (A)	Efficiency@ Max Load			Max Case Temp. (°C)	Input Current (Arms)			Max. Input Power (W)	Inrush Current (A _{pk} /50%- μ s)			THD @ Max Load (%)	Power Factor @ Max Load	Surge Protection Common/Diff (KV)	Weight (Lbs/kgs)
			120V	230V	277V		120 V	230 V	277 V		120 V _{in}	230 V _{in}	277 V _{in}				
75	54 ~ 107	0.10 ~ 0.70	89.5	91	91	80 °C	0.72	0.38	0.31	84	40/150	80 /150	100 /150	<20 See graph	>0.90 See graph	4/4	1.63/0.74

Wire Diagram

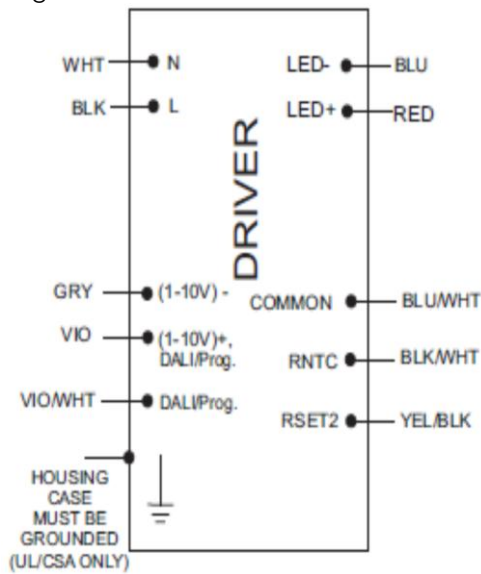

Input and output use lead-wires.
Lead-wires are 18AWG 105C/600V solid copper.

Lead Length

Standard Lead Length is 275 mm (\pm 30mm) on all wires outside the can

Dimming Method	Dimming Range	Minimum Output Current (A)	Other Comments
1-10V Isolated	10% ~ 100%	0.047	Dimming source current: 150 μ A (\pm 3%)
DALI	1 ~ 254	10% ~ 100%	Linear or Logarithmic Variation
Amp Dimming	30% ~ 100%	0.047	Linear

Enclosure

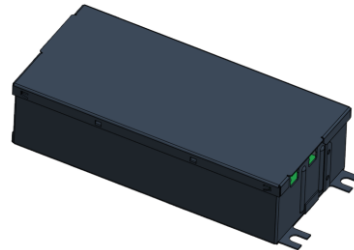

	(mm)
Case Length	(147.38)
Case Width	(70.00)
Case Height	(38.00)
Mounting Length	(155)
Mounting Width	(50.00)
Overall Length	(165.00)

Revised 09/03/2012

PHILIPS LIGHTING ELECTRONICS N.A.

10275 WEST HIGGINS ROAD · ROSEMONT, IL 60018
Tel: 800-322-2086 · Fax: 888-423-1882 · www.philips.com/advance
Customer Support/Technical Service: 800-372-3331 · OEM Support: 866-915-5886



9290 007 10103

Brand Name	XITANIUM
Description	Xitanium 75W 0.70A Prog+ GL-Z sXt
Input Voltage	120 ~ 230 ~ 277V
Input Frequency	50/60Hz
RoHS	Yes
Status	Preliminary

Electrical Specifications

Product Data

Order code	929000710103
Full product code	929000710103
Full product name	XITANIUM 75W 0.70A Prog+ GL-Z sXt
Net weight per piece	0.74 KG / 1.63 lbs
Interfaces	1-10V Dimming, DALI, AmpDim, Integrated Dynadimmer, AOC(via Rset), MTP (via RNTC)
Ambient Temp Range	-40C to +55C
Corresponding Tcase	-15C to +80C
0-10V Dimming Specifications	150µA ± 3% source current from driver, Vdim > 14.5V to shutdown driver. See dim curve for detail.
Line Voltage	120-277V
Line Current	0.72A @ 120V, 0.38A @230V, 0.31A @ 277V
Line Frequency	50/60Hz
Min. Mains voltage operational	108 V [min]
Max. Mains voltage operational	305V [max]
Life @ TC 70C	Refer to graph
Life @ TC 80C	Refer to graph
Suitable for Outdoor use?	Yes
Max TC	80C
Maximum ballast number on MCB 16A	11 [max]
Input Over-voltage	Can survive input over-voltage stress of 320VAC for 48 hours and 350VAC for 2 hours
Earth leakage current	<=0.35mA
Output Current ripple	30% @ 700 mA (ripple = pk-pk/avg)
THD total	Refer to graph
PF @ Max Load	Refer to graph
Wire Isolation	All wires are Double isolated
Isolation between input and output	Basic
Isolation towards housing	Double
Protections	Short Circuit and Open Circuit Protection for LED + and LED-
Standby power	< 1.0W

Installation & Application Notes:

Section I – Physical Characteristics

- 1.1 LED Driver shall be installed inside an electrical enclosure
- 1.2 Wiring inside electrical enclosure shall comply with 600V/105°C rating or higher.

Revised 09/03/2012

PHILIPS LIGHTING ELECTRONICS N.A.

10275 WEST HIGGINS ROAD · ROSEMONT, IL 60018
 Tel: 800-322-2086 · Fax: 888-423-1882 · www.philips.com/advance
 Customer Support/Technical Service: 800-372-3331 · OEM Support: 866-915-5886

9290 007 10103

Brand Name	XITANIUM
Description	Xitanium 75W 0.70A Prog+ GL-Z sXt
Input Voltage	120 ~ 230 ~ 277V
Input Frequency	50/60Hz
RoHS	Yes
Status	Preliminary

Electrical Specifications

I-10V Dimming Curve

Dimming source current from the driver: 150 μ A (\pm 3%) (@ 0<Vdim<8V)

LED Current Tolerance at any value of Vdim: \pm 5% of I_{max}

Minimum Dim Level: 10% - 100%

Guaranteed Shutdown driver with Vdim>14.5V. Current limit at 3mA typ (4mA Max) at 16V dim.

Guaranteed no shutdown driver with Vdim<12V

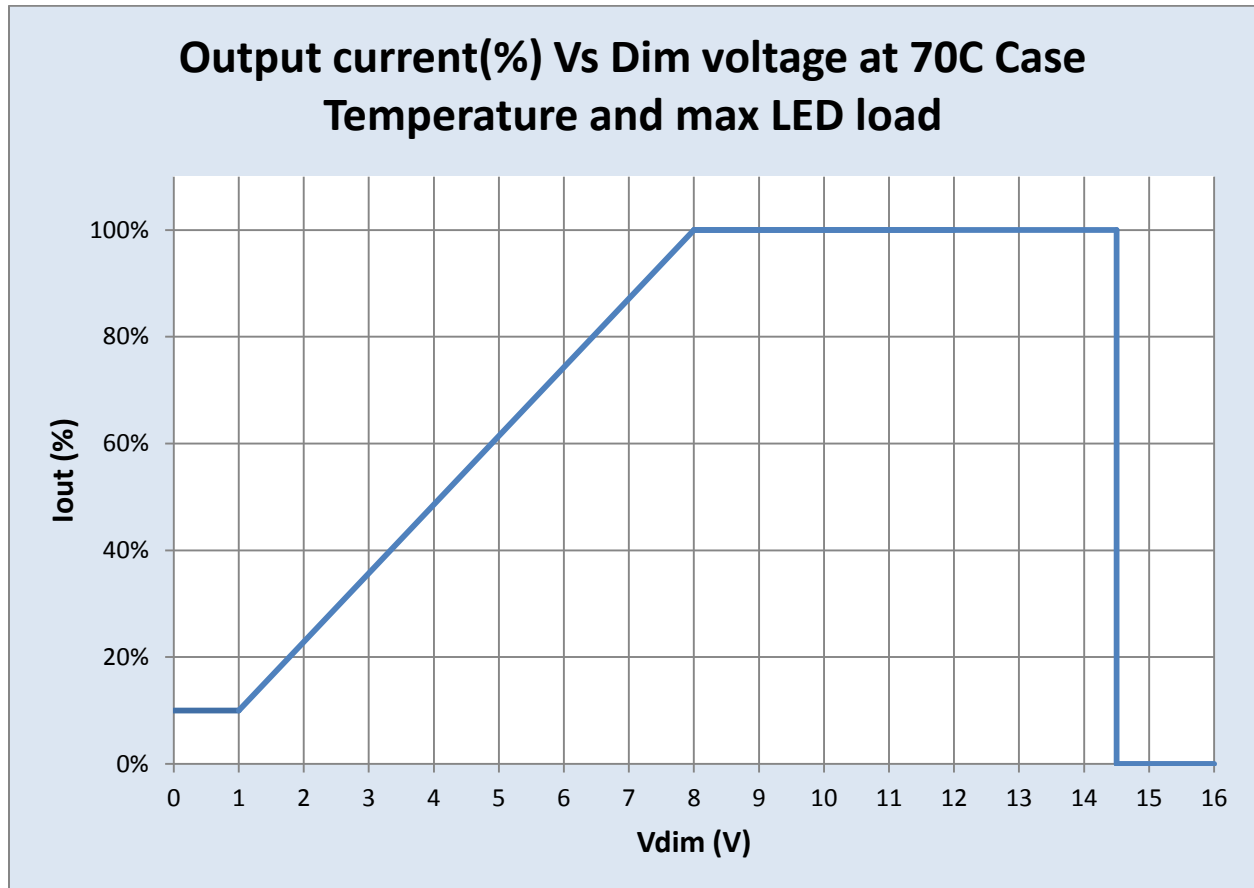

Revised 09/03/2012

PHILIPS LIGHTING ELECTRONICS N.A.

10275 WEST HIGGINS ROAD · ROSEMONT, IL 60018

Tel: 800-322-2086 · Fax: 888-423-1882 · www.philips.com/advance

Customer Support/Technical Service: 800-372-3331 · OEM Support: 866-915-5886

9290 007 10103

Brand Name	XITANIUM
Description	Xtanium 75W 0.70A Prog+ GL-Z sXt
Input Voltage	120 ~ 230 ~ 277V
Input Frequency	50/60Hz
RoHS	Yes
Status	Preliminary

Electrical Specifications

AOC (Adjustable Output Current) Settings:

LED current tolerance with variation of Rset2 is within $\pm 5\%$ of I_{max}

Rset(Ohms)	Current (mA)
0	100
100	100
110	105
120	111
130	116
150	125
160	130
180	138
200	146
220	155
240	166
270	176
300	190
330	204
360	215
390	228
430	245
470	261
510	277
560	297
620	318
680	340
750	368
820	392
910	422
1000	452
1100	485
1200	515
1300	545
1500	602
1600	632
1800	684
1870	700

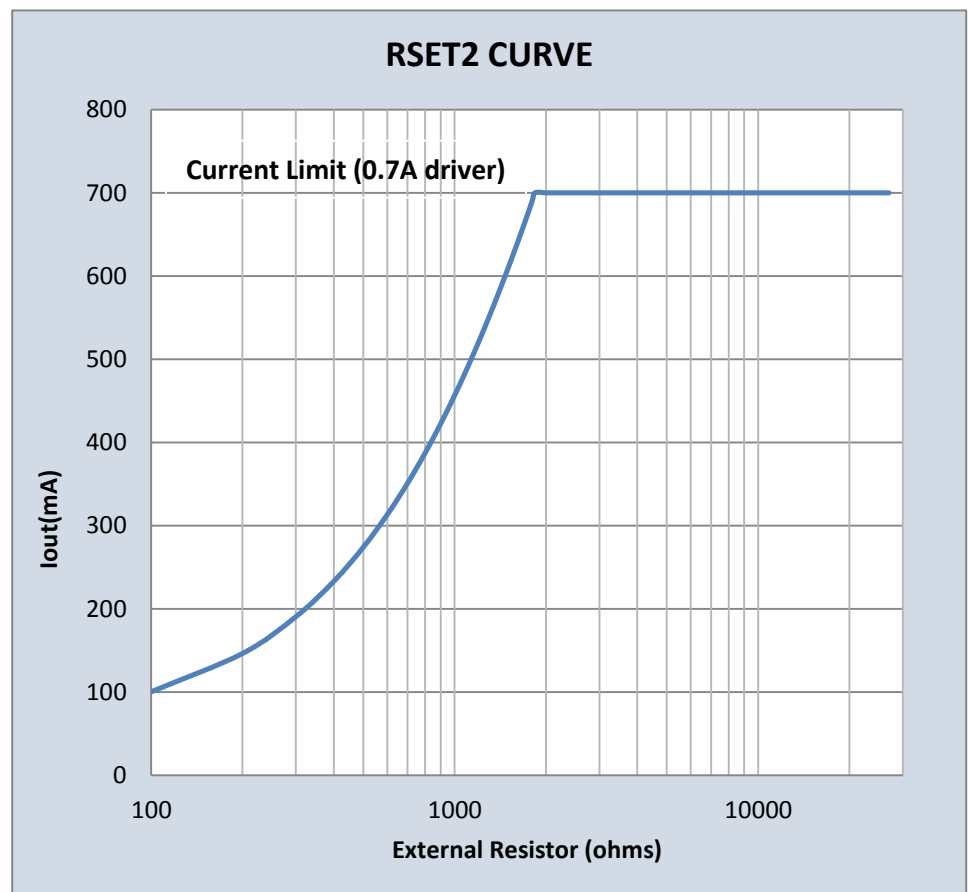

Revised 09/03/2012

PHILIPS LIGHTING ELECTRONICS N.A.

10275 WEST HIGGINS ROAD · ROSEMONT, IL 60018

Tel: 800-322-2086 · Fax: 888-423-1882 · www.philips.com/advance

Customer Support/Technical Service: 800-372-3331 · OEM Support: 866-915-5886



9290 007 10103

Brand Name	XITANIUM
Description	Xitanium 75W 0.70A Prog+ GL-Z sXt
Input Voltage	120 ~ 230 ~ 277V
Input Frequency	50/60Hz
RoHS	Yes
Status	Preliminary

Electrical Specifications

Operating Window:

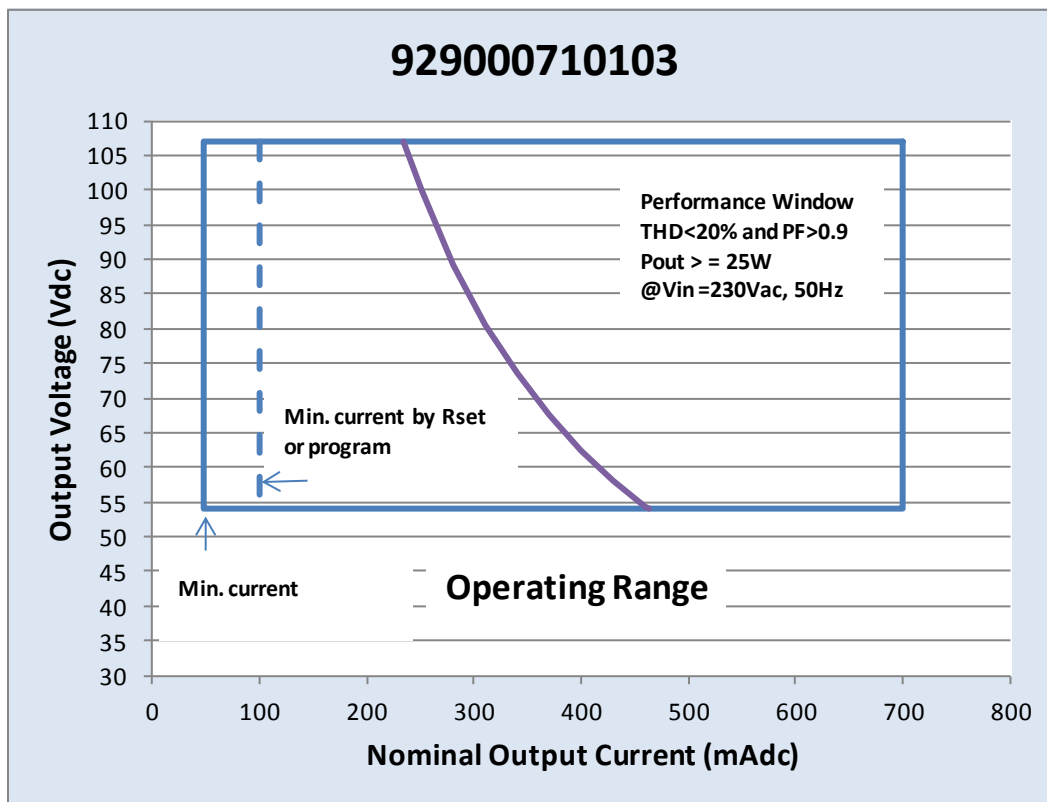

Revised 09/03/2012

PHILIPS LIGHTING ELECTRONICS N.A.
10275 WEST HIGGINS ROAD · ROSEMONT, IL 60018
Tel: 800-322-2086 · Fax: 888-423-1882 · www.philips.com/advance
Customer Support/Technical Service: 800-372-3331 · OEM Support: 866-915-5886

9290 007 10103

Brand Name	XITANIUM
Description	Xtanium 75W 0.70A Prog+ GL-Z sXt
Input Voltage	120 ~ 230 ~ 277V
Input Frequency	50/60Hz
RoHS	Yes
Status	Preliminary

Electrical Specifications

Module Thermal Protection

MTP options	Temperature range:	Default programmed values	Min delta (MTP max-MTP warn)	Dimming range	Missing NTC Signal*
NTC: 15k+390ohms Murata: NCPI5XWI53E03RC	MTP warn: 50C MTP max: 110C	MTP warn: 80C MTP max: 90C	10C	100% to 10%	NO
NTC:10k Murata: NCPI8XH103J03RB	MTP warn: 50C MTP max: 85C	N/A	5C	100% to 10%	YES
Philips LED light Engine	Depending on the module connected to the driver See module datasheet			100% to 10%	NO

* MTP feature has to be enabled to get the missing NTC signal

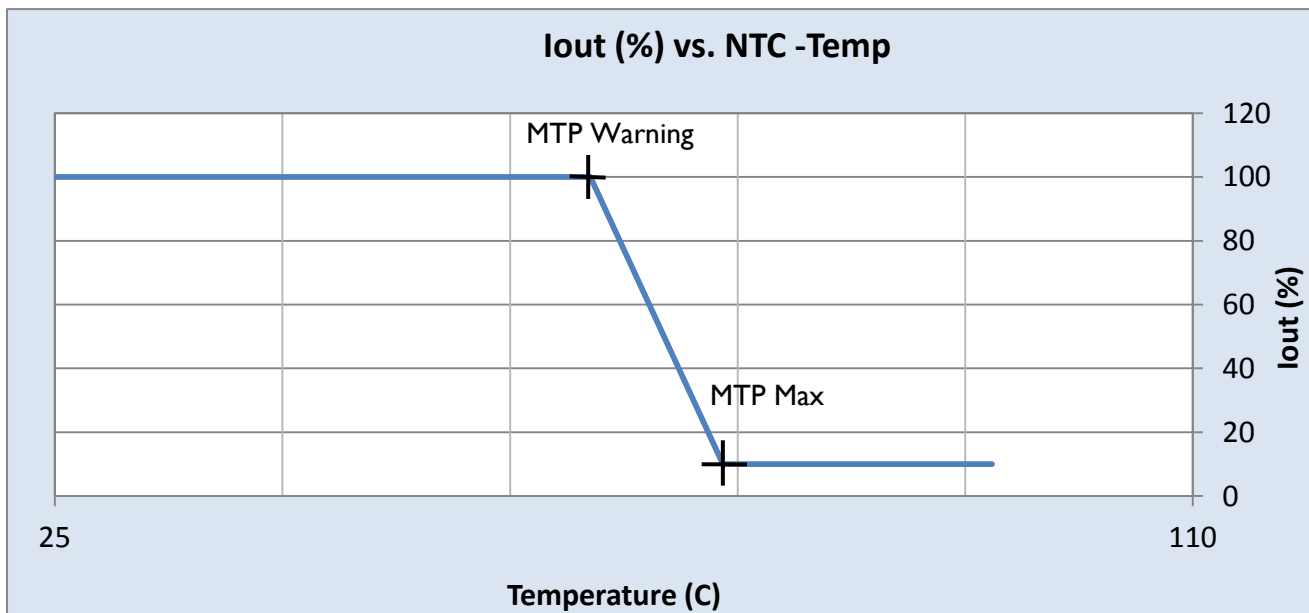

Revised 09/03/2012

9290 007 10103

Brand Name	XITANIUM
Description	Xtanium 75W 0.70A Prog+ GL-Z sXt
Input Voltage	120 ~ 230 ~ 277V
Input Frequency	50/60Hz
RoHS	Yes
Status	Preliminary

Electrical Specifications

AmpDim Curve:

Parameter	Min	Max	Increments
Start Voltage	170Vrms	250Vrms	1Vrms(configurable by software)
Stop Voltage	150Vrms	230Vrms	1Vrms(configurable by software)
Start Percentage	30%	100%	1%(configurable by software)
Stop Percentage	30%	100%	1%(configurable by software)

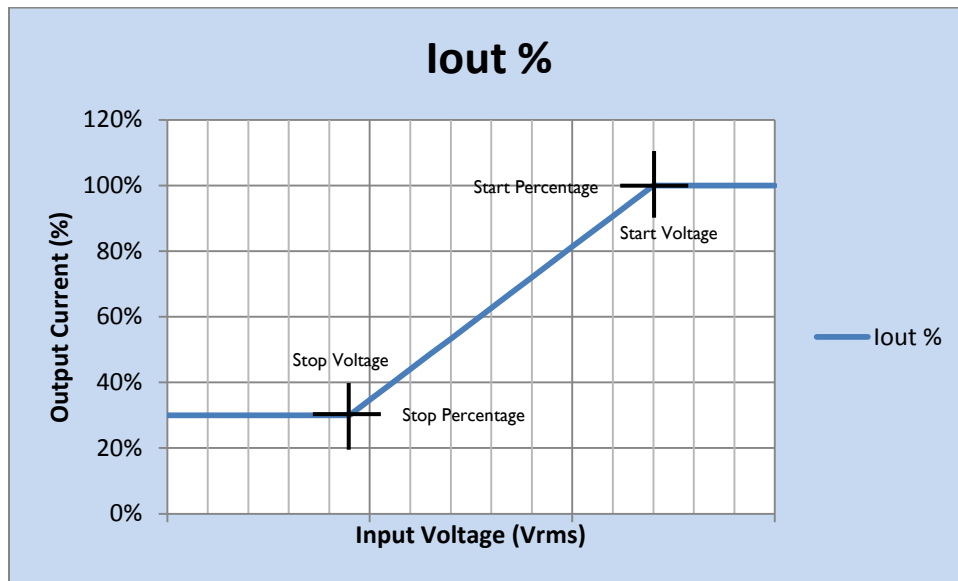

$$\text{Current Tolerance } \Delta I (\%) = (\text{Start Percentage} - \text{Stop Percentage}) \times 5 / (\text{Start Voltage} - \text{Stop Voltage})$$

Revised 09/03/2012



9290 007 10103

Brand Name	XITANIUM
Description	Xitanium 75W 0.70A Prog+ GL-Z sXt
Input Voltage	120 ~ 230 ~ 277V
Input Frequency	50/60Hz
RoHS	Yes
Status	Preliminary

Electrical Specifications

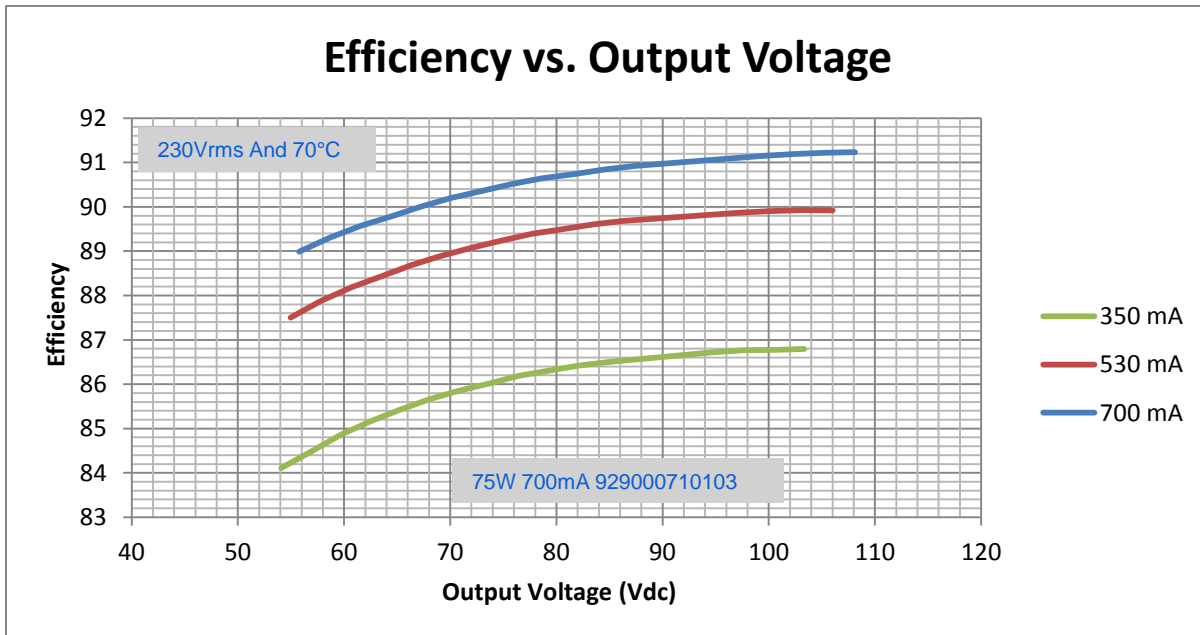
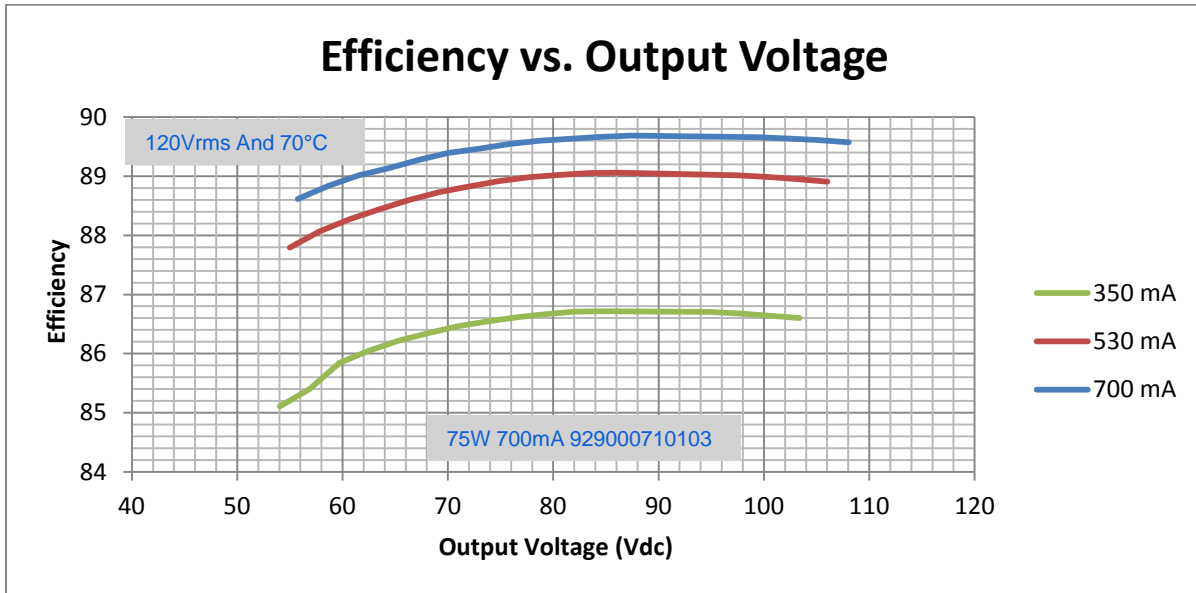

Revised 09/03/2012

PHILIPS LIGHTING ELECTRONICS N.A.
10275 WEST HIGGINS ROAD · ROSEMONT, IL 60018
Tel: 800-322-2086 · Fax: 888-423-1882 · www.philips.com/advance
Customer Support/Technical Service: 800-372-3331 · OEM Support: 866-915-5886



9290 007 10103

Brand Name	XITANIUM
Description	Xtanium 75W 0.70A Prog+ GL-Z sXt
Input Voltage	120 ~ 230 ~ 277V
Input Frequency	50/60Hz
RoHS	Yes
Status	Preliminary

Electrical Specifications

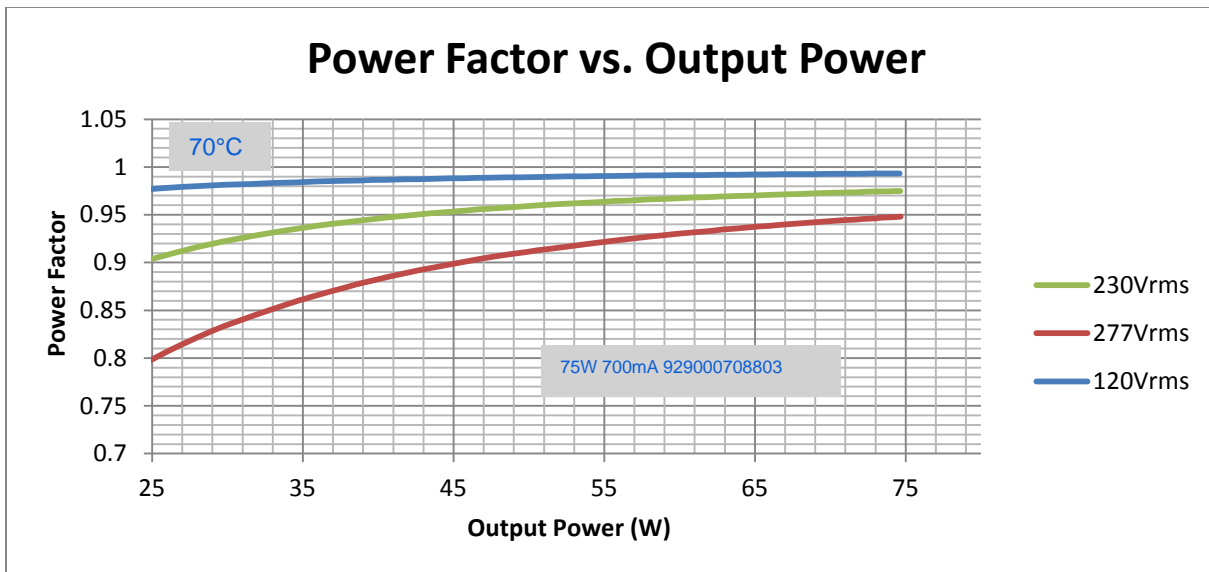
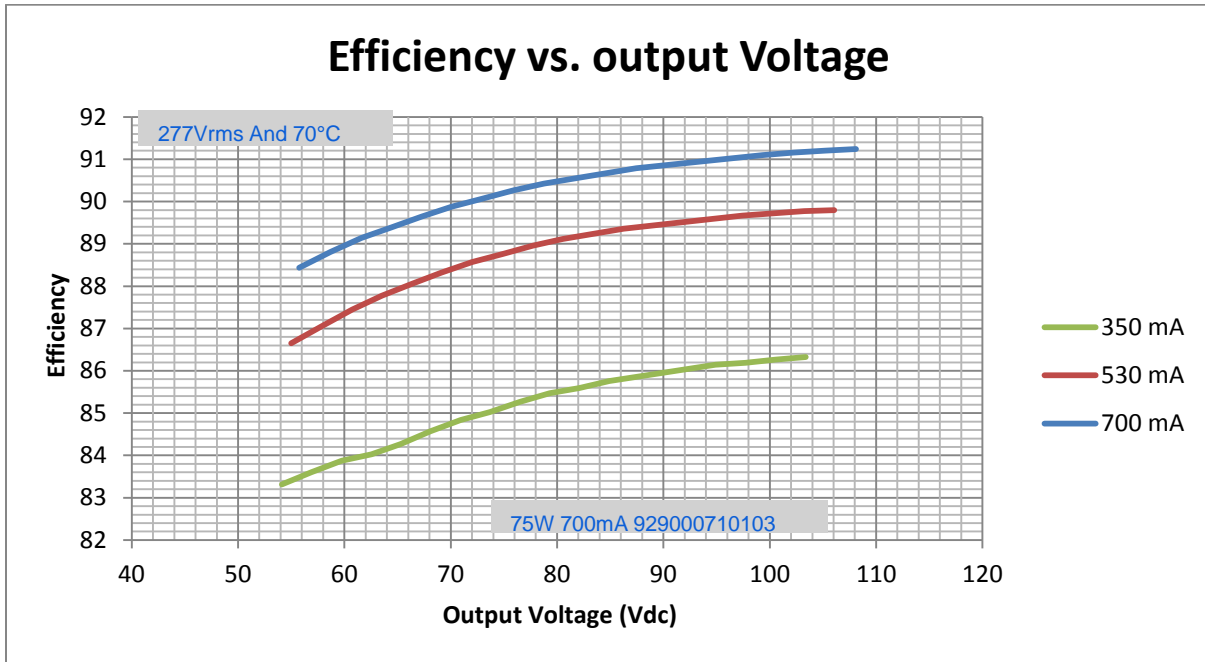

Revised 09/03/2012

9290 007 10103

9290 007 10103	
Brand Name	XITANIUM
Description	Xitanium 75W 0.70A Prog+ GL-Z sXt
Input Voltage	120 ~ 230 ~ 277V
Input Frequency	50/60Hz
RoHS	Yes
Status	Preliminary

Electrical Specifications

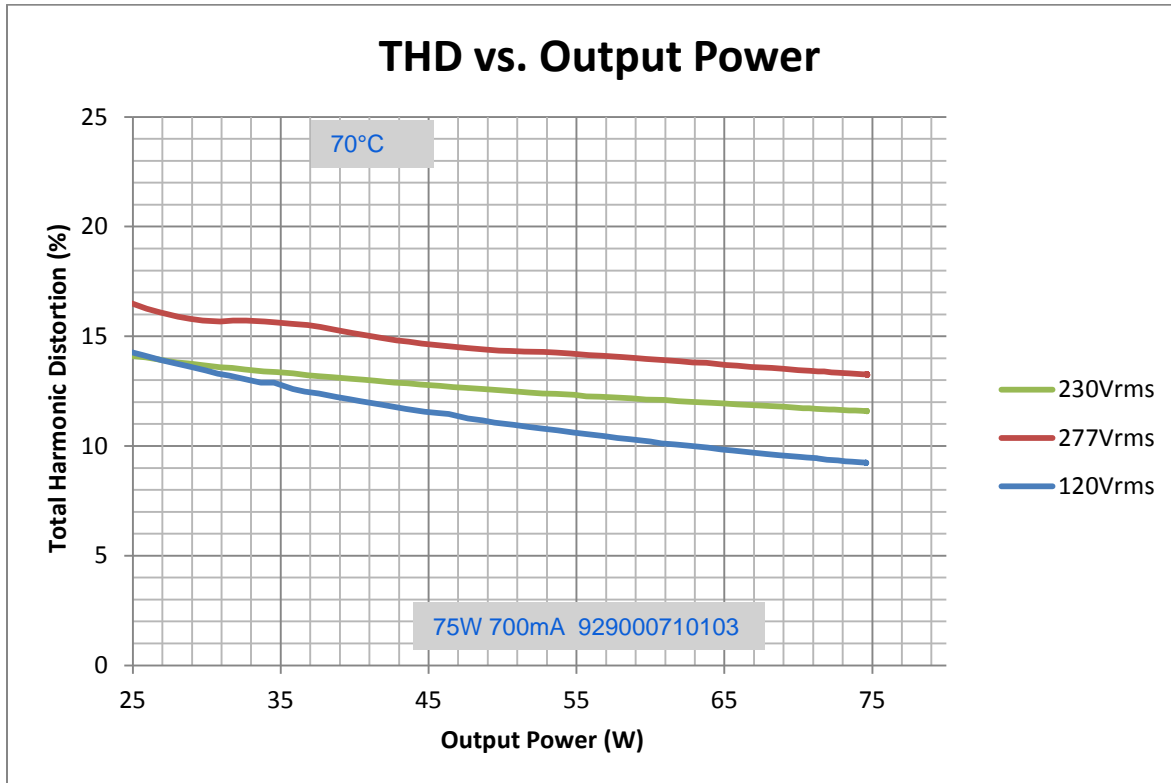

Programming Tool:

For latest version please check www.philips.com/xitanium

Revised 09/03/2012

PHILIPS LIGHTING ELECTRONICS N.A.
10275 WEST HIGGINS ROAD · ROSEMONT, IL 60018
Tel: 800-322-2086 · Fax: 888-423-1882 · www.philips.com/advance
Customer Support/Technical Service: 800-372-3331 · OEM Support: 866-915-5886

9290 007 10103

Brand Name	XITANIUM
Description	Xtanium 75W 0.70A Prog+ GL-Z sXt
Input Voltage	120 ~ 230 ~ 277V
Input Frequency	50/60Hz
RoHS	Yes
Status	Preliminary

Electrical Specifications

Iout vs. Tcase of Driver:

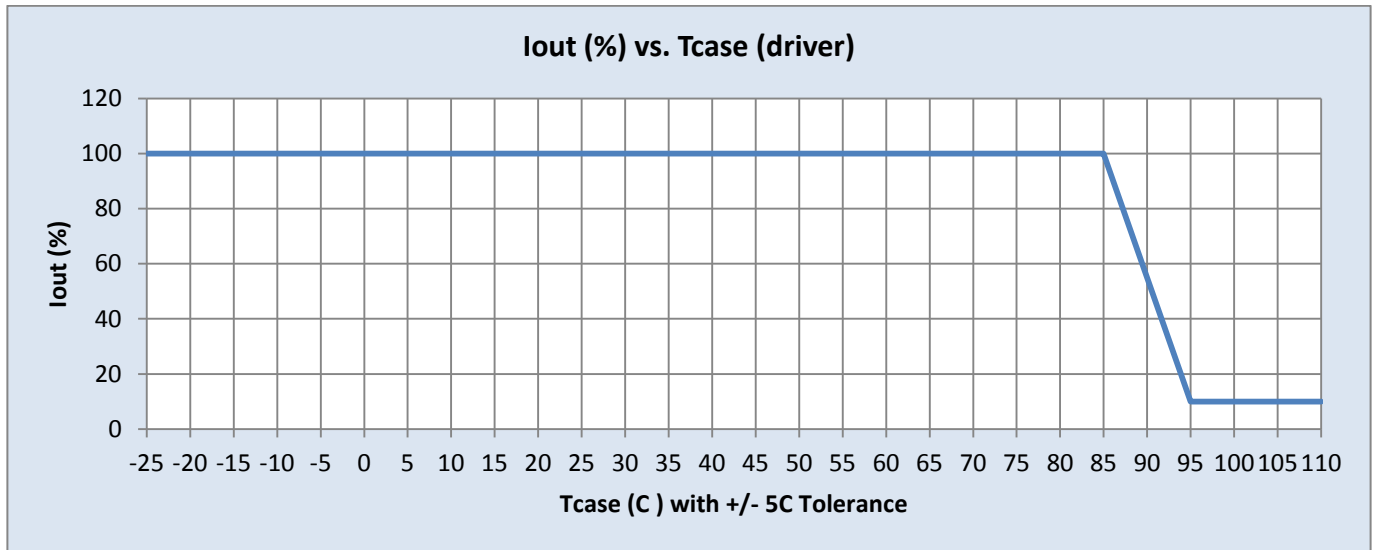

Inrush Current Info:

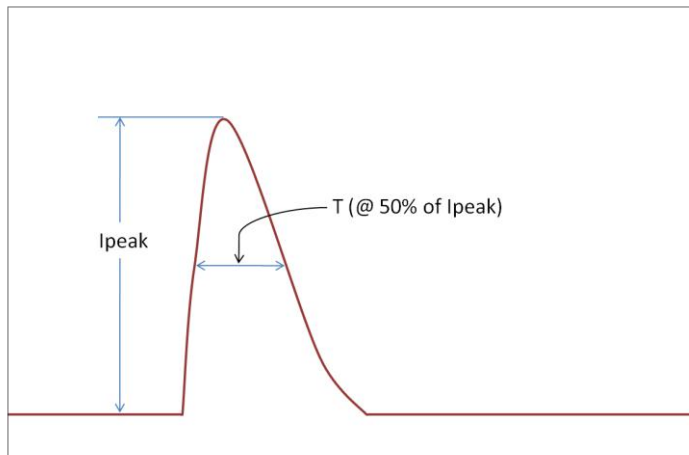

Vin	Ipeak	T (@ 50% of Ipeak)
120 Vrms	40 A	150 μ s
230 Vrms	80 A	150 μ s
277 Vrms	100 A	150 μ s

Revised 09/03/2012

PHILIPS LIGHTING ELECTRONICS N.A.

10275 WEST HIGGINS ROAD · ROSEMONT, IL 60018
 Tel: 800-322-2086 · Fax: 888-423-1882 · www.philips.com/advance
 Customer Support/Technical Service: 800-372-3331 · OEM Support: 866-915-5886



9290 007 10103

Brand Name	XITANIUM
Description	Xitanium 75W 0.70A Prog+ GL-Z sXt
Input Voltage	120 ~ 230 ~ 277V
Input Frequency	50/60Hz
RoHS	Yes
Status	Preliminary

Electrical Specifications

Lifetime vs. Tcase of Driver:

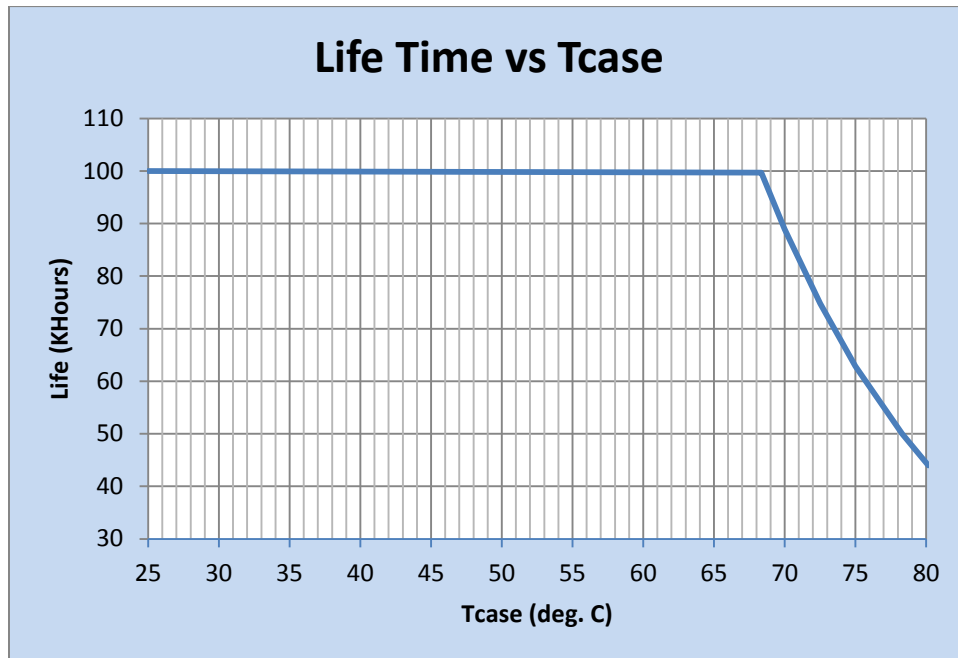

Failure Rate Info based upon MTBF modeling:

- 90% survivals at end of life @ \leq Tcase 70°C

Failure Rate Info based upon field call rate data:

<0.01% per 1 kHr @ \leq Tcase 70 C

Revised 09/03/2012

PHILIPS LIGHTING ELECTRONICS N.A.

10275 WEST HIGGINS ROAD · ROSEMONT, IL 60018

Tel: 800-322-2086 · Fax: 888-423-1882 · www.philips.com/advance

Customer Support/Technical Service: 800-372-3331 · OEM Support: 866-915-5886



9290 007 10103

Brand Name	XITANIUM
Description	Xitanium 75W 0.70A Prog+ GL-Z sXt
Input Voltage	120 ~ 230 ~ 277V
Input Frequency	50/60Hz
RoHS	Yes
Status	Preliminary

Electrical Specifications

CE isolation

Basic isolation: 2U+1000V
 Double Isolation: 4U+2750V

Isolation	Input Wires	Output Wires	DALI Wires	0-10V Wires	Chassis
Input Wires	NA	Basic	Basic	Basic	Double
Output Wires	Basic	NA	Basic	Basic	Double
DALI Wires	Basic	Basic	NA	NA	Double
0-10V Wires	Basic	Basic	NA	NA	Double
Chassis	Double	Double	Double	Double	NA

UL isolation

Isolation	Input Wires	Output Wires	DALI Wires (Class 1&2)	0-10V Wires (Class 1&2)	Chassis
Input Wires	NA	2xU+1KV	2.5KVac	2.5KVac	2xU+1KV
Output Wires	2xU+1KV	NA	2.5KVac	2.5KVac	2xU+1KV
DALI Wires(Class 1&2)	2.5KVac	2.5KVac	NA	NA	2.5KVac
0-10V Wires(Class 1&2)	2.5KVac	2.5KVac	NA	NA	2.5KVac
Chassis	2xU+1KV	2xU+1KV	2.5KVac	2.5KVac	NA

Revised 09/03/2012