



LED Driver

Xitanium SR

75W 0.10-2.0A 54V SR
XI075C200V054VPT1



The Xitanium SR LED Driver can help reduce complexity and cost of light fixtures used in wireless connected lighting systems. It features a standard digital interface to enable direct connection to any suitably qualified RF sensor on the market. Functionality is integrated into the SR driver that ordinarily would require additional auxiliary components. The result is a simpler, less expensive light fixture that can enable every fixture to become a wireless node.

Specifications

| Input Voltage (Vrms) | Output Power (W) | Output Voltage (V) | Output Current (A) | Efficiency @ Max Load | Max. Case Temp. (°C) | Input Current (Arms) | Max. Input Power (W) | Inrush Current (A _{pk} /10%-µs) | THD @ Max. Load | Power Factor @ Max. Load | Surge Protection Common/Diff (KV) | Weight (Lbs/kgs) | Envir. Protection Rating |
|----------------------|------------------|--------------------|--------------------|-----------------------|----------------------|----------------------|----------------------|--|-----------------|--------------------------|-----------------------------------|------------------|--------------------------|
| 120 | 75 | 27 ~ 54 | 0.10 – 2.0 | >87% | Life 75 °C | 0.7 | 84 | 21/403 | <10% | >0.95 | 2.5/2.5 | 0.85/0.38 | UL Dry & Damp |
| 277 | | | | >89% | UL 85 °C | 0.3 | | 50/358 | <15% | | | | |

Enclosure

| | In. (mm) |
|-----------------|------------|
| Case Length | 16.6 (424) |
| Case Width | 1.18 (30) |
| Case Height | 1.0 (25.4) |
| Mounting Length | 16.3 (415) |
| Overall Length | 16.6 (424) |

Wiring Diagram

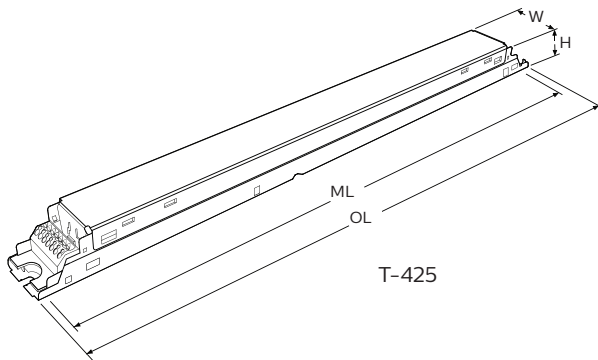
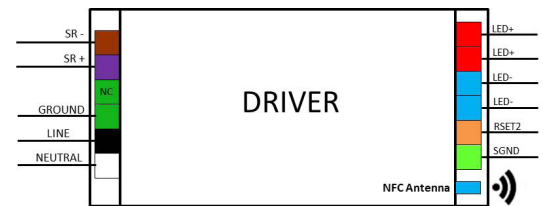

Both output positive and negative connectors are equivalent (same electrical point).

Input and output use WAGO 250 connectors.

Connect wires:

Use 18 AWG Solid Copper Wire
Rated >=300V.
Strip Wire 3/8".

| Dimming Method | Dimming Range | Minimum Output Current (A) |
|----------------|--|----------------------------|
| DALI | 5% ~ 100% (for output current range 0.50-2.0A) | 0.0250 |

Xitanium 75W 0.10-2.0A 54V SR

Features

- Standard digital interface based on DALI 2.0 for connection of one driver to one sensing/ RF device
- Auxiliary power for sensors through digital connection, default "on" for connection to single sensing/RF device
- Occupancy and accurate energy reporting
- Dim-to-off capability
- Low standby power (<1W)

- Drive current setting via SimpleSet wireless programming or Rset2
- 5-year limited warranty*

Benefits

- Enable wireless interoperability with multiple sensors/network systems
- Reduce complexity and cost of fixture by eliminating auxiliary components ordinarily required for powering sensors, switching fixture off and monitoring energy use

- Future proof through standard interface to any suitable sensor and ease of adjustable drive current

Application

- Indoor linear applications such as troffers and pendants

Product Data

All specifications are typical and at 25°C Tcase unless otherwise specified.

| Ordering Information | |
|------------------------------------|--|
| Order Code | XI075C200V054VPT1 |
| Full Product Code | XI075C200V054VPT1M (Mid-pack, 12pcs/box) |
| Full Product Name | XITANIUM 75W 0.10-2.0A 54V 120-277V SR |
| Net Weight Per Piece | 0.38 KG / 0.85 lbs |
| Input Information | |
| Inrush Current | Per NEMA 410 |
| Line Voltage (AC Operation) | 120-277VAC +/- 10% |
| Line Current | 0.70A @ 120V, 0.30A @ 277V |
| Line Frequency | 50/60Hz |
| Output Information | |
| Output Voltage Range | 27VDC to 54VDC |
| Output Current Ripple | <15% at max lout (ripple = pk-avg/avg) Low frequency (<120 Hz) content <5% |
| Output Current Tolerance | ±5% at max output current |
| Open Circuit Voltage | 60V |
| Protections | Short Circuit and Open Circuit Protection for LED + and LED-, mis-wiring protection |
| Features | |
| AOC (Adjustable Output Current) | 100mA to 2000mA via external resistor or SimpleSet programming (refer to graphs and notes) |
| Life @ TC 75°C | 50000 hr [nom] (refer to graphs) |
| Suitable for Outdoor Use? | No |
| Interfaces | AOC (RSET2 or SimpleSet), SR (DALI 2.0) |
| Ambient Temp Range | -20°C to +50°C |
| Max Case Temperature (Tcase) | 85°C for UL, 75°C for life |
| Input Over-voltage | Can survive input over-voltage stress of 320VAC for 48 hours and 350VAC for 2 hours |
| Earth Leakage Current | 0.75 mA [max] |
| THD Total | Refer to graph |
| Power Factor | Refer to graph |
| SR Interface | DALI 2.0 |
| Sensor Power Supply | 52-60mA (55mA typ.); 12vdc-20vdc (14vdc typ.) (refer to graph) |
| Power Reporting Accuracy | ±0.9W/±4% |
| Environment & Approbation | |
| Agency Approbations | UL8750, UL1310, UL935, CSA-C22.2 No. 250.13-12, CSA C22.2 No. 223 |
| Audible Noise | <24dB Class A |
| Isolation Between Output and Input | Refer to table |
| Isolation of Controls | Refer to table |
| EMC (Electromagnetic Compliance) | Meets FCC 47 Part 15 Class A |
| Envir. Protection Rating | UL Dry & Damp |

Xitanium 75W 0.10-2.0A 54V SR

Electrical Specifications

All the specifications are typical and at 25°C Tcase unless specified otherwise.

Adjustable Output Current (AOC) Info

LED current tolerance with variation of Rset2 is within $\pm 5\%$ of Imax.

| Rset (Ohms) | Current (mA) | Rset (Ohms) | Current (mA) |
|-------------|--------------|-------------|--------------|
| 1 | 100 | 1800 | 684 |
| 100 | 100 | 2000 | 733 |
| 110 | 106 | 2200 | 780 |
| 120 | 111 | 2400 | 823 |
| 130 | 116 | 2700 | 883 |
| 150 | 125 | 3000 | 941 |
| 160 | 130 | 3300 | 993 |
| 180 | 138 | 3600 | 1042 |
| 200 | 146 | 3900 | 1085 |
| 220 | 155 | 4300 | 1143 |
| 240 | 166 | 4700 | 1192 |
| 270 | 176 | 5100 | 1238 |
| 300 | 190 | 5600 | 1293 |
| 330 | 204 | 6200 | 1350 |
| 360 | 215 | 6800 | 1402 |
| 390 | 228 | 7500 | 1454 |
| 430 | 245 | 8200 | 1503 |
| 470 | 261 | 9100 | 1558 |
| 510 | 277 | 10000 | 1604 |
| 560 | 300 | 11000 | 1653 |
| 620 | 318 | 12000 | 1694 |
| 680 | 340 | 13000 | 1730 |
| 750 | 368 | 15000 | 1793 |
| 820 | 392 | 16000 | 1817 |
| 910 | 422 | 18000 | 1864 |
| 1000 | 452 | 20000 | 1902 |
| 1100 | 485 | 22000 | 1934 |
| 1200 | 515 | 24000 | 1965 |
| 1300 | 545 | 27000 | 2000 |
| 1500 | 602 | 36000 | 2000 |
| 1600 | 632 | >100000 | 2000 |

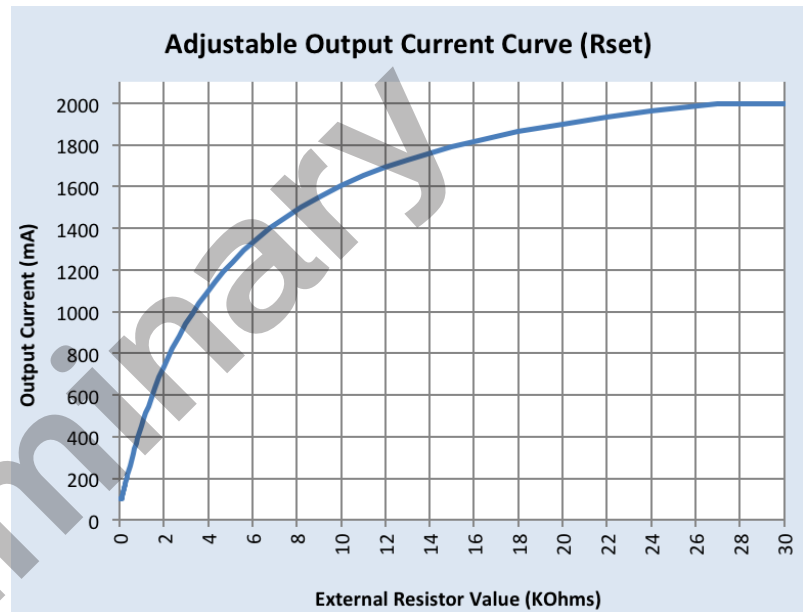

Notes

1. There are two ways to adjust the current:
 - a. Using a resistor between Rset2 & SGND leads
 - i. Any through hole or SMD resistor with >0.25W and >20V can be used as RSET between Rset and SGND pins.
 - ii. Driver will default to 1100mA when Rset is left open.
 - b. Using SimpleSet programming (visit www.philips.com/simpleset for details)
2. The driver is by default set to Rset2.

Xitanium 75W 0.10-2.0A 54V SR

Electrical Specifications

All the specifications are typical and at 25°C Tcase unless specified otherwise.

SR Power Supply Characteristics (Typical)

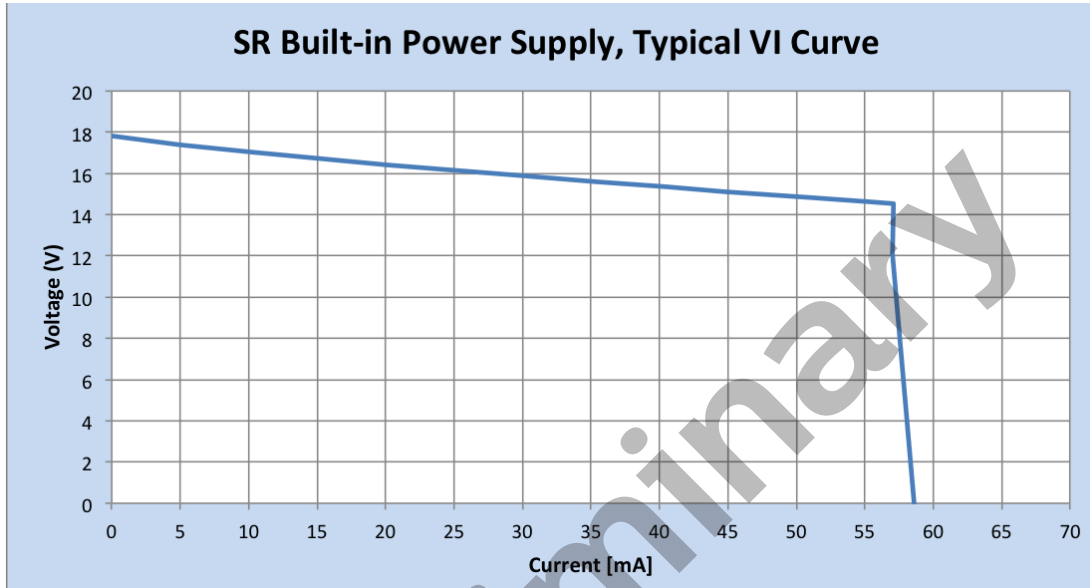

Note:

Power supply through digital connection, default "on," for connection of one driver to one sensing/RF device. Consult your Philips representative for use with multiple devices.

Operating Window

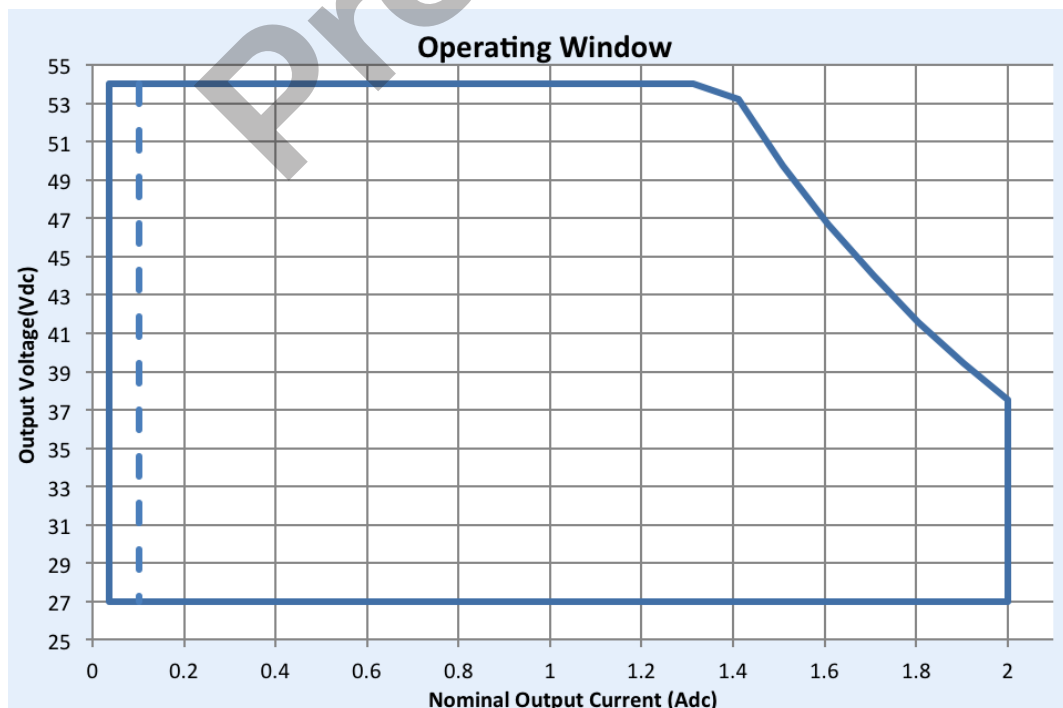

Note:

For 5% dimming output current setting through AOC should be >0.50A.

Xitanium 75W 0.10-2.0A 54V SR

Electrical Specifications

All the specifications are typical and at 25°C Tcase unless specified otherwise.

Dimming Characteristics

Dimming is accomplished through the 2-wire DALI connection to the sensor. DALI standard IEC62386_102 Edition 2 defines the logarithmic dimming curve. DALI standard IEC62386_107 Edition 1 defines the linear dimming curve as well as the command for switching between logarithmic and linear curves.

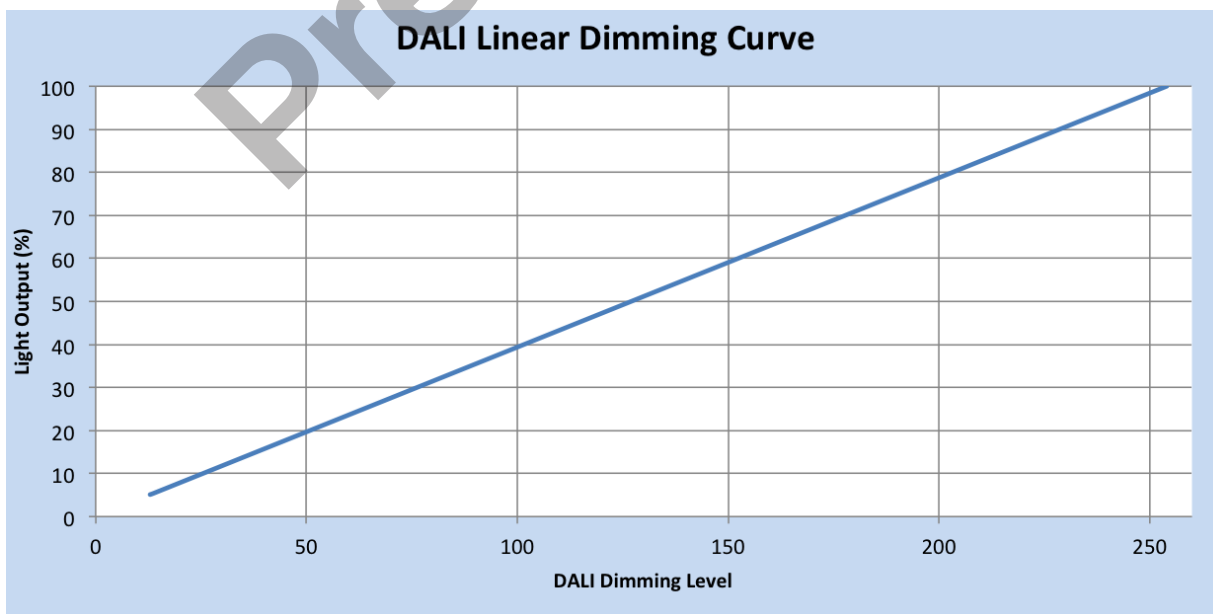
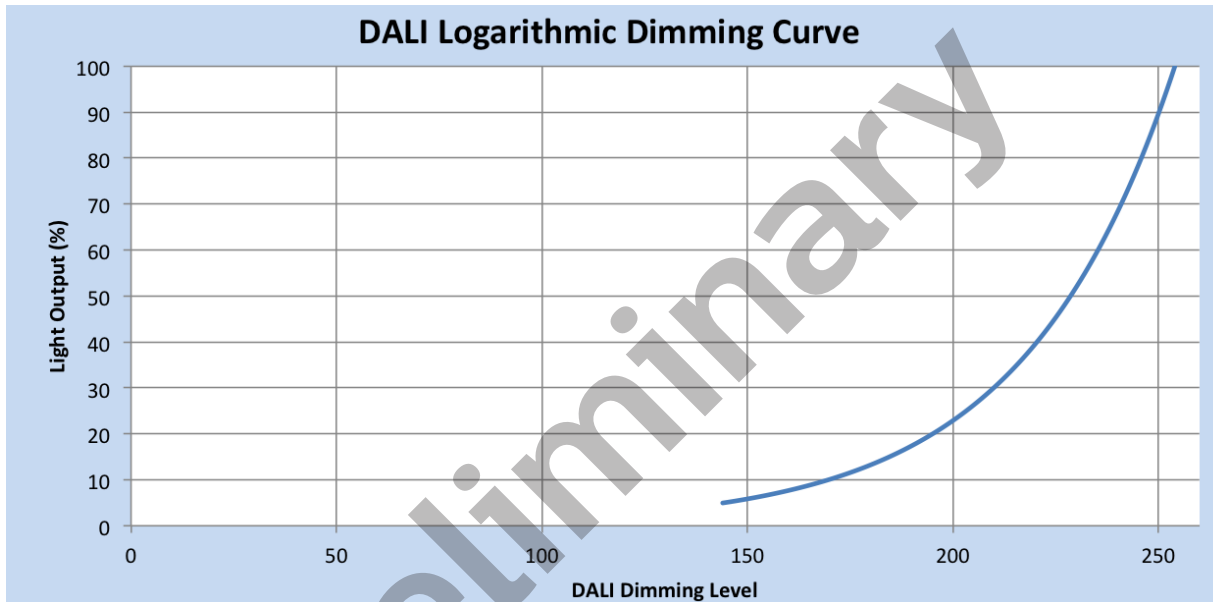

Xitanium 75W 0.10-2.0A 54V SR

Performance Characteristics

Based on measurements on a typical sample. The accuracy of the measurements is within the tolerance of the measurement instruments. The graphs are meant to be a guideline and not a specification.

Power Factor vs. Output Power

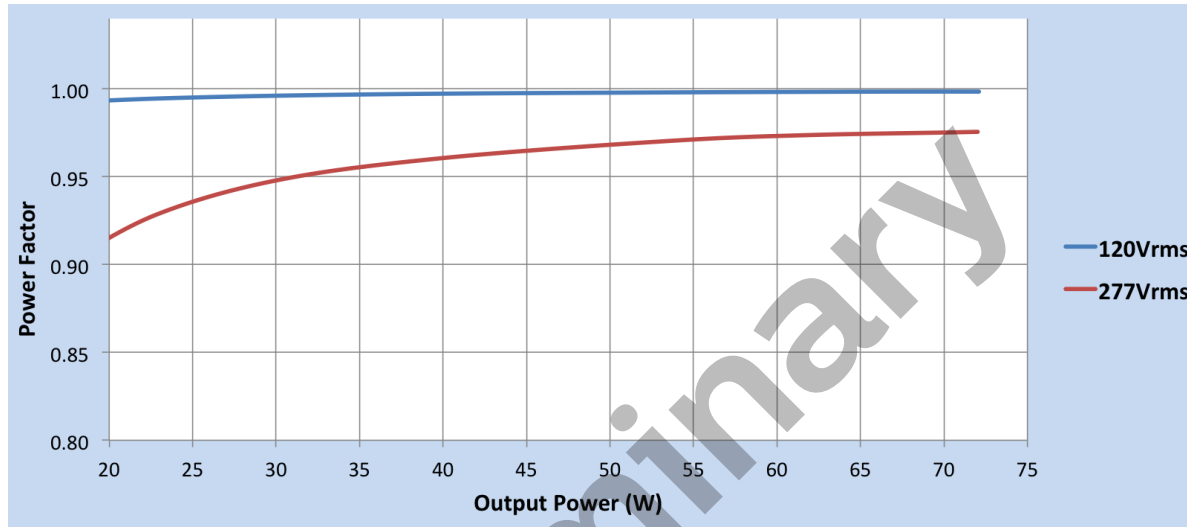

Total Harmonic Distortion vs. Output Power

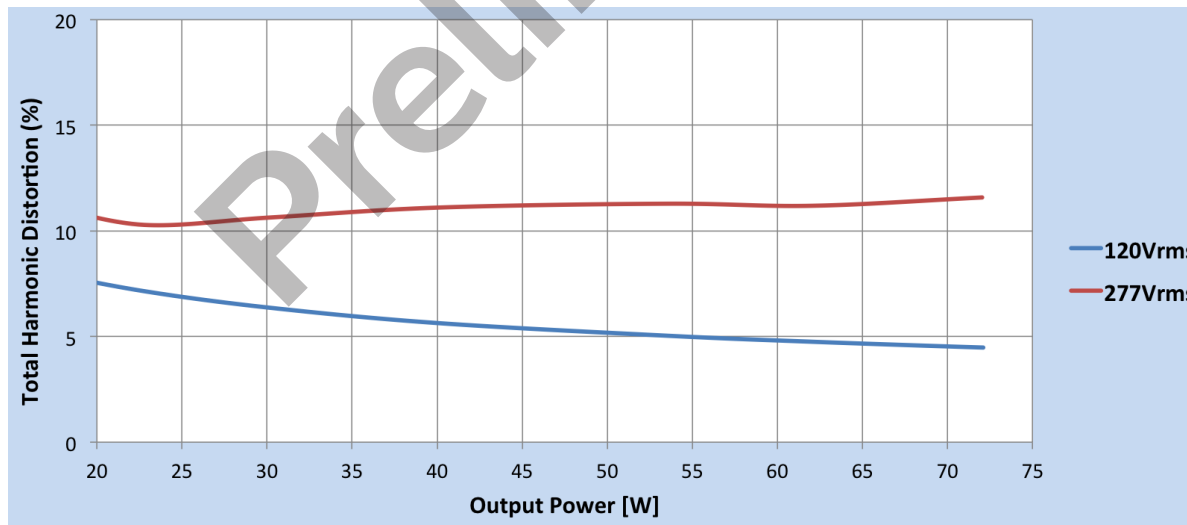

Xitanium 75W 0.10-2.0A 54V SR

Performance Characteristics

Based on measurements on a typical sample. The accuracy of the measurements is within the tolerance of the measurement instruments. The graphs are meant to be a guideline and not a specification.

Output Current vs. Driver Case Temperature (Tcase)

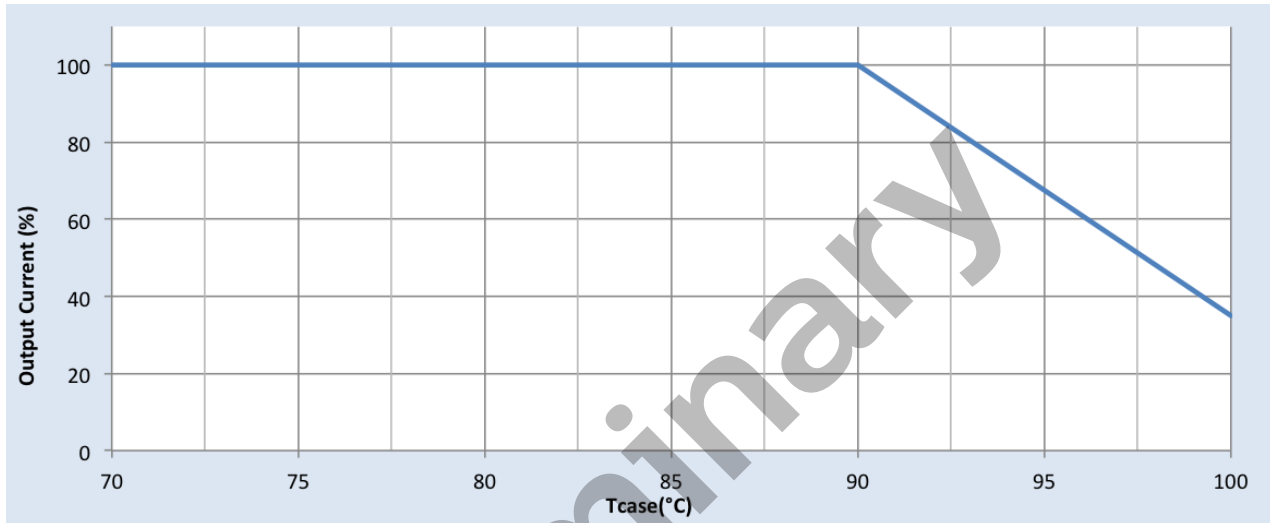

Lifetime vs. Tcase of Driver

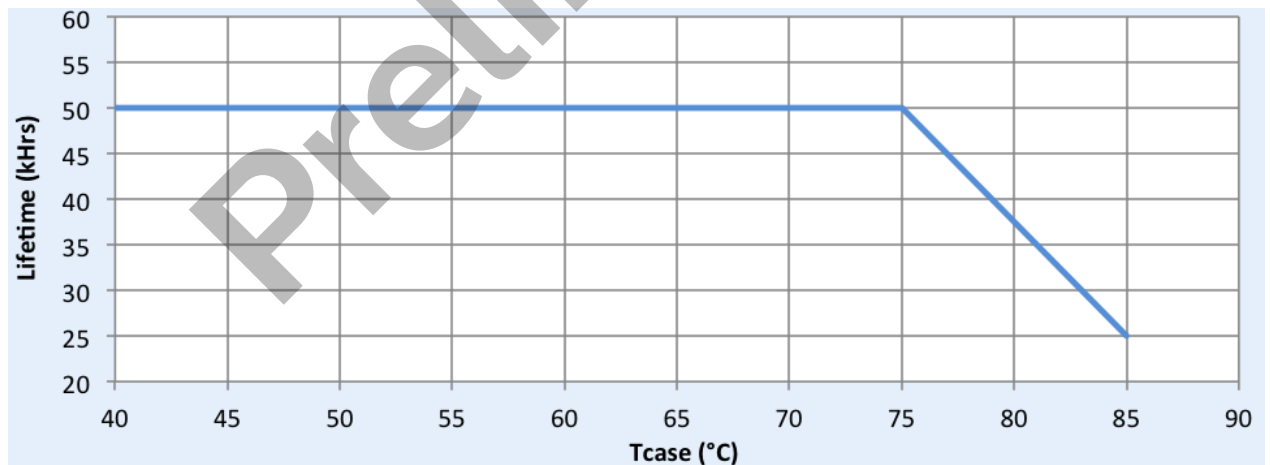

Xitanium 75W 0.10-2.0A 54V SR

Performance Characteristics

Based on measurements on a typical sample. The accuracy of the measurements is within the tolerance of the measurement instruments. The graphs are meant to be a guideline and not a specification.

Performance Plots

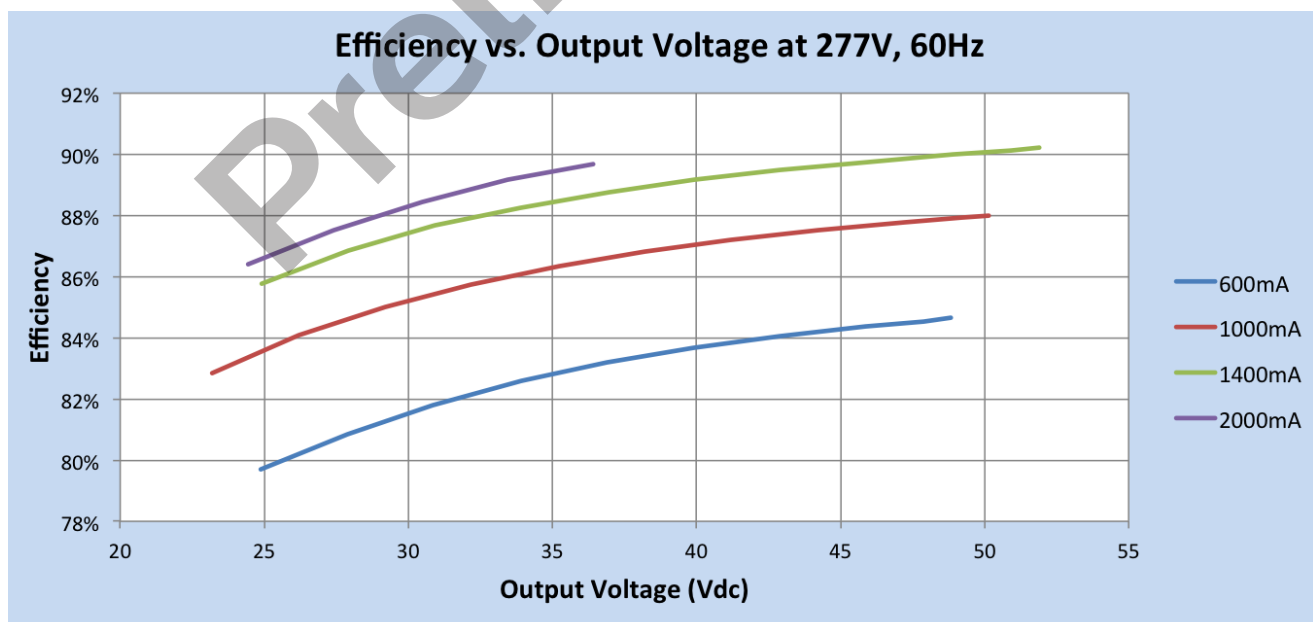
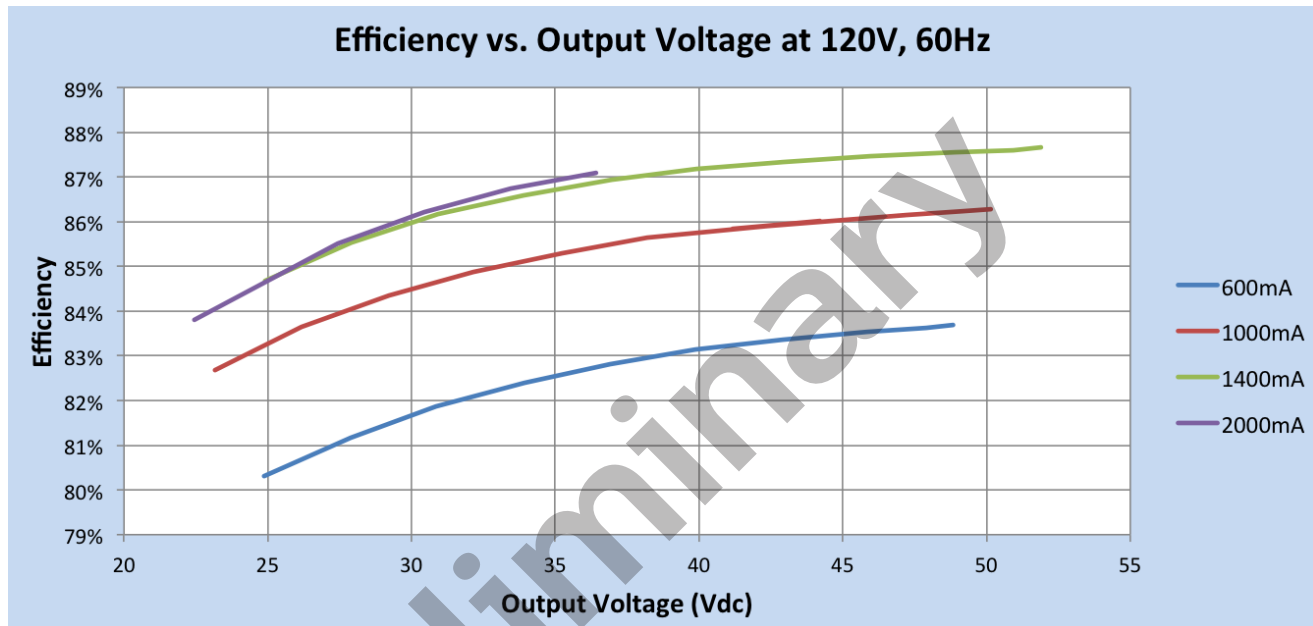

Xitanium 75W 0.10-2.0A 54V SR

Inrush Current Info

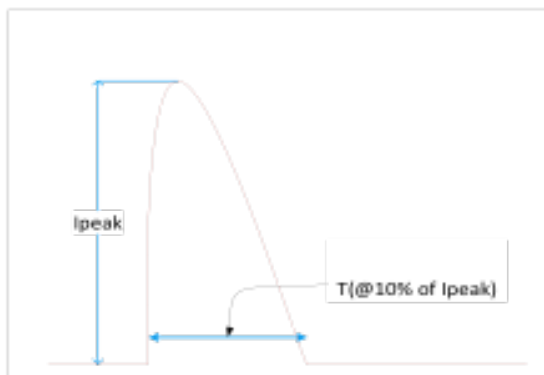

| Vin | Ipeak | T (@ 10% of Ipeak) |
|----------|-------|--------------------|
| 120 Vrms | 21 A | 403 μs |
| 277 Vrms | 50 A | 358 μs |

Lightning Surge Info

| ANSI Surge Type | Differential Mode (L-N) | Common Mode (L-G, N-G, L&N-G) |
|-----------------------------|-------------------------|-------------------------------|
| 100 kHz Ring Wave (w/t 30Ω) | >2.5kV | >2.5kV |

Isolation:

| Isolation | Input Connectors | Output + AOC | SR Connectors | Chassis |
|------------------|------------------|------------------|---------------|------------------|
| Input Connectors | NA | 2xU+1kV 1600V | 2500V | 2xU+1kV 1600V |
| Output + AOC | 2xU+1kV 1600V | NA | 500V | 500V |
| SR Connectors | 2500V | 500V | NA | 500V |
| Chassis | 2xU+1kV 1600V | 500V | 500V | NA |

Installation & Application Notes

- LED driver shall be installed inside an electrical enclosure.
- Wiring inside electrical enclosure shall comply with 300V/105°C rating or higher.
- Max number of LEDs in series should not exceed 16.
- Max LED voltage should not exceed 54V under all operating conditions.
- Rset can be used to adjust output current between 100 to 2000 mA for fixed output operation.
- Driver is configured for connection to one suitably qualified sensing/RF device. Consult your Philips representative for use with multiple devices.

UL Conditions of Acceptability

Please contact your Philips representative for a copy of the latest UL Conditions of Acceptability (COA).

† Restrictions on Hazardous Substances (RoHS) is a European directive (2002/95/EC) designed to limit the content of 6 substances [lead, mercury, cadmium, hexavalent chromium, polybrominated biphenyls (PBB), and polybrominated diphenyl ethers (PBDE)] in electrical and electrical products. For products used in North America, compliance with RoHS is voluntary and self-certified.



© 2015 Koninklijke Philips N.V. All rights reserved.
Philips reserves the right to make changes in specifications and/or to discontinue any product at any time without notice or obligation and will not be liable for any consequences resulting from the use of this publication.
www.philips.com/xitaniumsr



Philips Lighting North America Corporation
10275 W. Higgins Road, Rosemont IL 60018
Tel: 800-322-2086 Fax: 888-423-1882
Customer/Technical Service: 800-372-3331
OEM Support: 866-915-5886

Imported by: Philips Lighting
A division of Philips Electronics Ltd.
281 Hillmount Rd, Markham, ON, Canada L6C 2S3
Tel. 800-668-9008