

PHILIPS

LED Modules

Fortimo SLM

Fortimo LED SLM Gen 4 Crisp White

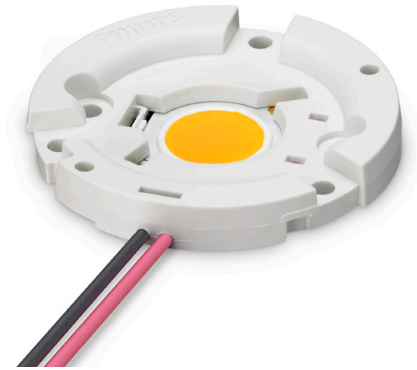

The Fortimo LED SLM Gen 4 is a next generation solution for spotlight and downlight applications. It is a product in line with the Fortimo brand promise of light quality and a smart system. We provide you with a system proposition ranging from 1100lm to 4500lm in preset outputs, with the flexibility to tune as per your needs.

This module is available in the following options. It is possible to combine these with any of the drivers as described in the design-in guide available at www.philips.com/ledmodulesna. A list of possible Rsets is provided below to set the output current of Philips Xitanium LED driver at different levels. More information about tuning can be found further on in the document.

Commercial Product Name	12NC
Fortimo LED SLM 1100lm 930 CW L9 G4	9290 009 57106
Fortimo LED SLM 1100lm 930 CW L13 G4	9290 009 49406
Fortimo LED SLM 2000lm 930 CW L13 G4	9290 009 49806
Fortimo LED SLM 3000lm 930 CW L15 G4	9290 009 03306
Fortimo LED SLM 3800lm 930 CW L19 G4	9290 009 03406

Associated Rsets

Commercial Product Name	12NC	Value (Ω)	Type
Fortimo LED Rset 300mA	929000727713	560	Poke-in
Fortimo LED Rset 500mA	929000727813	1200	Poke-in
Fortimo LED Rset 750mA	929000727913	2050	Poke-in
Fortimo LED Rset 950mA	929000728013	3090	Poke-in
Fortimo LED Rset 1200mA	929000728113	4780	Poke-in

Associated Drivers

Driver List	Dimming Mechanism	Current Setting Mechanism
XI013C030V048DNM1	0-10V dimming	Rset2
XI020C050V042RNP1	Leading Edge and Trailing Edge	Dip Switch
XI025C100V045DNM1	0-10V dimming	Rset2
XI036C100V048DNMX	0-10V dimming	Rset2
XI050C100V054DNMX	0-10V dimming	Rset2
XI050C100V054XPL1	Trailing Edge and 0-10V dimming @ 120V only	Rset1, Rset2 or programmable
XI095C275V054DNF5	0-10V dimming	Rset3

Fortimo LED SLM Gen 4 Crisp White

Features

- Ability to operate your module at a desired current to get a certain lumen output with a high lm/W or lm/S
- High lumen output out of small Light Emitting Surface (LES) sizes for narrow beam angles and small reflector designs with punch
- High Tc nominal of 85°C
- Zhaga standardized high quality holder concept
- High quality of light

- Dedicated solutions for special needs including the SLM Crisp White

- One-stop shop for your system (detailed list of complementary partners in design-in guide)

Benefits

- High energy efficiency
- Flexibility to tune the performance as per your need by modifying the operating point
- Luminaire manufacturability and ease of design-in
- Excellent thermal management
- Smart systems with Xitanium drivers
- Covered by Philips limited warranty¹

Application

- SLM Gen 4 for accent lighting and down lighting for retail, hospitality and supermarkets
- SLM Crisp White is ideal when bright and clean whites and rich and saturated colors are needed

Optical Characteristics – Table per CCT

Fortimo LED SLM 1100lm L9 930 CW

Parameter	Min	Typ	Max	Unit
Luminous Flux	830	930	1030	lm
Module Efficiency		88		lm/W
Correlated Color Temperature		3000		K
Color Coordinates		(0.43, 0.395)		-
Color Consistency		3		SDCM
CRI		92		-
Radiation Angle		115		deg
Thermal Power		16.1		W

Note: Specifications stated at Tc nom = 85°C and I nom = 300 mA

Ri	R1	R2	R3	R4	R5	R6	R7	R8	R9	R10	R11	R12	R13	R14	R15
92	93	95	94	90	92	93	91	84	64	86	89	84	93	96	92

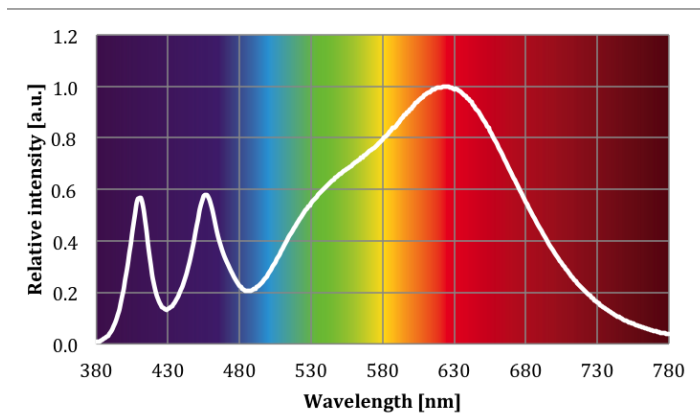

1. View limited warranty at http://www.usa.lighting.philips.com/connect/tools_literature/warranties.wpd for details and restrictions.

Fortimo LED SLM Gen 4 Crisp White

Optical Characteristics – Table per CCT

Fortimo LED SLM 1100lm L13 930 CW

Parameter	Min	Typ	Max	Unit
Luminous Flux	1340	1490	1640	lm
Module Efficiency		83		lm/W
Correlated Color Temperature		3000		K
Color Coordinates		(0.434, 0.403)		-
Color Consistency		3		SDCM
CRI		92		-
Radiation Angle		115		deg
Thermal Power		14.6		W

Note: Specifications stated at Tc nom = 85°C and I nom = 500 mA

Ri	R1	R2	R3	R4	R5	R6	R7	R8	R9	R10	R11	R12	R13	R14	R15
92	93	95	94	90	92	93	91	84	64	86	89	84	93	96	92

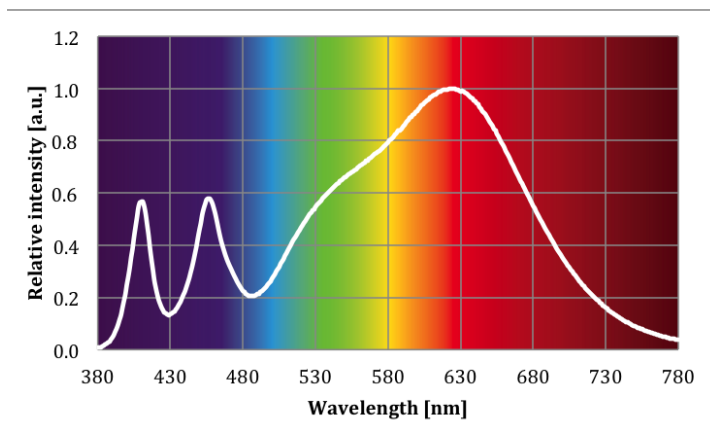

Fortimo LED SLM Gen 4 Crisp White

Optical Characteristics – Table per CCT

Fortimo LED SLM 2000lm L13 930 CW

Parameter	Min	Typ	Max	Unit
Luminous Flux	1960	2180	2400	lm
Module Efficiency		80		lm/W
Correlated Color Temperature		3000		K
Color Coordinates		(0.43, 0.395)		-
Color Consistency		3		SDCM
CRI		92		-
Radiation Angle		115		deg
Thermal Power		22.5		W

Note: Specifications stated at Tc nom = 85°C and I nom = 750 mA

Ri	R1	R2	R3	R4	R5	R6	R7	R8	R9	R10	R11	R12	R13	R14	R15
92	93	95	94	90	92	93	91	84	64	86	89	84	93	96	92

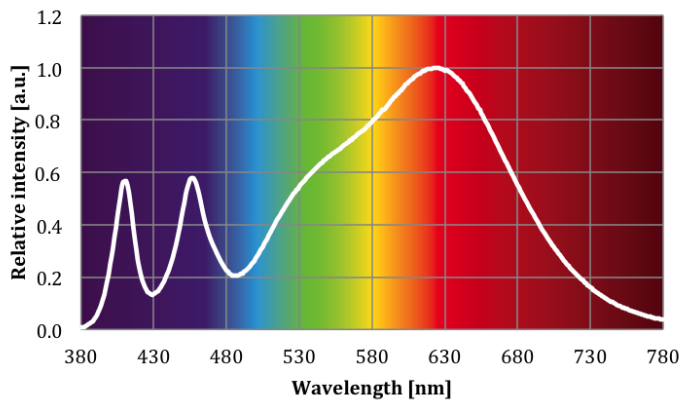

Fortimo LED SLM Gen 4 Crisp White

Optical Characteristics – Table per CCT

Fortimo LED SLM 3000lm L15 930 CW

Parameter	Min	Typ	Max	Unit
Luminous Flux	2490	2770	3050	lm
Module Efficiency		82		lm/W
Correlated Color Temperature		3000		K
Color Coordinates		(0.43, 0.395)		-
Color Consistency		3		SDCM
CRI		92		-
Radiation Angle		115		deg
Thermal Power		27.4		W

Note: Specifications stated at Tc nom = 85°C and I nom = 950 mA

Parameter	Min	Typ	Max	Unit
Luminous Flux	2600	2890	3180	lm
Module Efficiency		81		lm/W
Thermal Power		27.5		W

Note: Specifications stated at Tc nom = 85°C and I = 1000 mA

Ri	R1	R2	R3	R4	R5	R6	R7	R8	R9	R10	R11	R12	R13	R14	R15
92	93	95	94	90	92	93	91	84	64	86	89	84	93	96	92

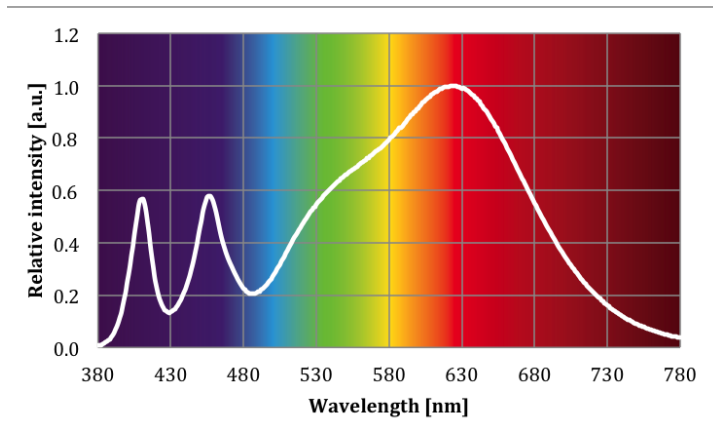

Fortimo LED SLM Gen 4 Crisp White

Optical Characteristics – Table per CCT

Fortimo LED SLM 3800lm L19 930 CW

Parameter	Min	Typ	Max	Unit
Luminous Flux	3240	3610	3980	lm
Module Efficiency		85		lm/W
Correlated Color Temperature		3000		K
Color Coordinates		(0.43, 0.395)		-
Color Consistency		3		SDCM
CRI		92		-
Radiation Angle		115		deg
Thermal Power		34		W

Note: Specifications stated at Tc nom = 85°C and I nom = 1200 mA

Parameter	Min	Typ	Max	Unit
Luminous Flux	2780	3090	3400	lm
Module Efficiency		89		lm/W
Thermal Power		25.5		W

Note: Specifications stated at Tc nom = 85°C and I = 1000 mA

Ri	R1	R2	R3	R4	R5	R6	R7	R8	R9	R10	R11	R12	R13	R14	R15
92	93	95	94	90	92	93	91	84	64	86	89	84	93	96	92

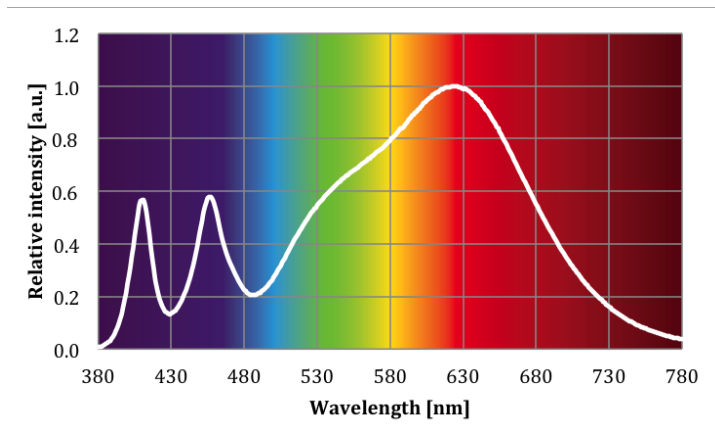

Fortimo LED SLM Gen 4 Crisp White

Beam Shape

The Philips Fortimo LED SLM generates a Lambertian beam shape, which is a pragmatic starting point for OEMs wishing to design secondary optics.

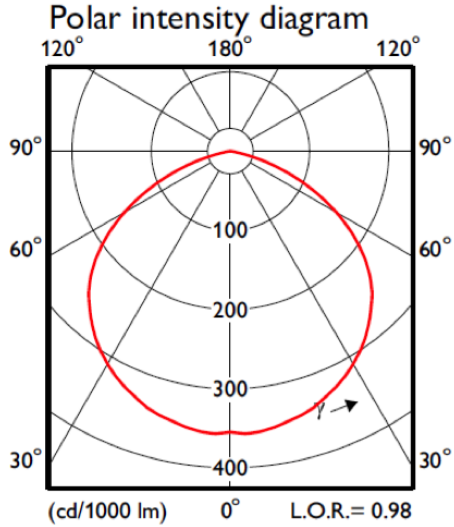

Electrical Characteristics

Parameter	SLM 1100lm 930 CW L9	SLM 1100lm 930 CW L13	SLM 2000lm 930 CW L13	SLM 3000lm 930 CW L15	SLM 3800lm 930 CW L19	Units
Nominal Current	300	500	750	950	1200	mA
Forward Voltage	35.4	35.8	36.3	35.6	35.2	V
Power Consumption	10.6	17.9	27.2	33.8	42.3	W

Note: Specifications stated at Tc nom = 85°C

Lifetime

Parameter	Min	Typ	Max	Unit
Lumen Maintenance B50L70	50,000			hrs
Δu'v' at 6000 Hours			0.002	-
Critical Failures (10%)	50,000			hrs

Note: Specifications stated at Tc nom = 85°C and nominal current of module

Parameter	SLM 1100lm 930 CW L9	SLM 1100lm 930 CW L13	SLM 2000lm 930 CW L13	SLM 3000lm 930 CW L15	SLM 3800lm 930 CW L19	Units
Nominal Tc	85	85	85	85	85	°C
Max Tc	95	95	95	95	95	°C
Nominal Current	300	500	750	950	1200	mA
Max Current	530	790	1050	1580	2000	mA

Note: Tc life ≤ 85 °C (measured at 25 °C ambient temperature)

- Nominal value at which performance is specified.
- Maximum value for safety (at this temperature, warranty need not apply).

Fortimo LED SLM Gen 4 Crisp White

Abs Max Ratings

Parameter	Min	Typ	Max	Unit
Case Temperature Tc Max			95	°C
ESD Human Body Model (HBM) Class 3A JESD22-A114-E			8	kV
ESD Machine Model (MM) Class B JESD22-A115-B			400	kV
Operating Ambient Temperature	-20		40	°C
Storage Temperature	-40		80	°C

Mechanical Characteristics

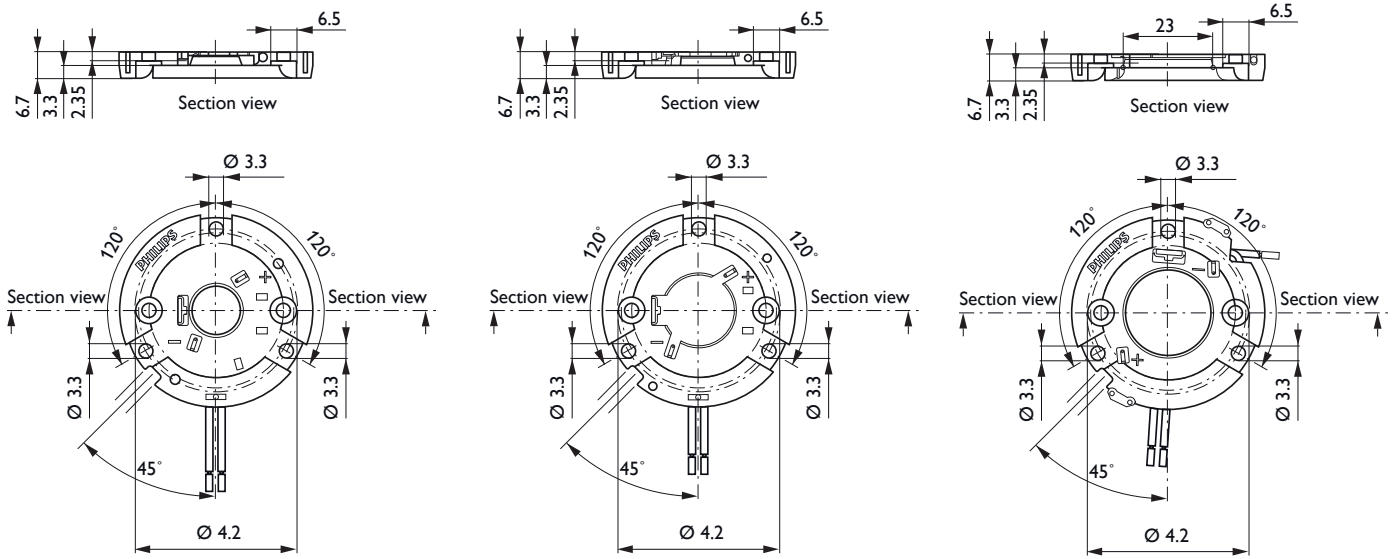

Fortimo LED SLM 1100lm 930 CW L9 G4

Fortimo LED SLM 1100lm 930 CW L13 G4
 Fortimo LED SLM 2000lm 930 CW L13 G4
 Fortimo LED SLM 3000lm 930 CW L15 G4

Fortimo LED SLM 3800lm 930 CW L19 G4

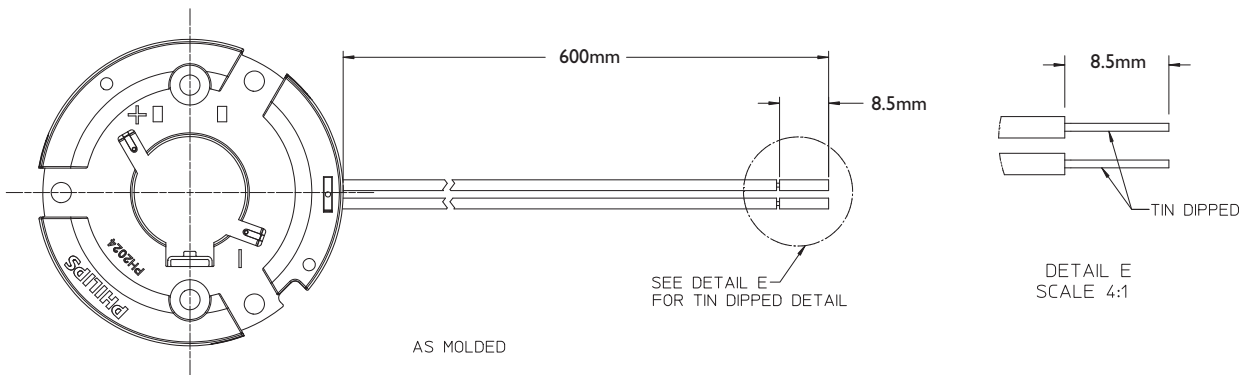

Fortimo LED SLM Gen 4 Crisp White

Application Information

Compliance and Approval

CSA/UL

Environmental

RoHS

Application Information

Zhaga*	SLM 1100lm 930 CW L9	SLM 1100lm 930 CW L13	SLM 2000lm 930 CW L13	SLM 3000lm 930 CW L15	SLM 3800lm 930 CW L19
LES Diameter [mm]	9	13	13	15	19
Rotational Symmetry S	0.9	0.9	0.9	0.9	0.9
Uniformity Parameter U	100%	100%	100%	100%	100%
Correlated Color Temperature [K]	3000	3000	3000	3000	3000
Color Rendering Index	>90	>90	>90	>90	>90

* Measurements showing compliancy to Zhaga book 3 version 1.2 have been done on the 3000lm L15 module.

IP Rating	No IP rating
Overheating Protection	No protection

Fortimo LED SLM Gen 4 Crisp White

Tuning Information

Flux and Efficacy Versus Current (at Nominal Temperature) 1100lm L9

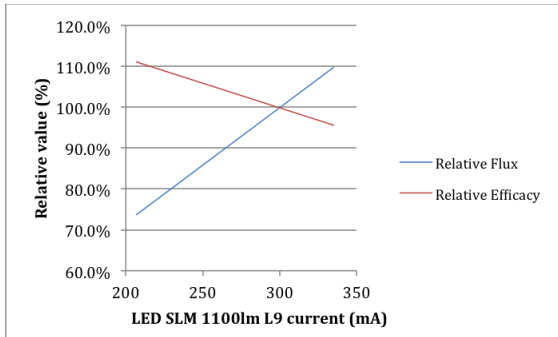

I [A]	Rel flux	Rel effic
207	73.4%	111.2%
270	91.8%	103.1%
292	98.0%	101.0%
300	100.0%	100.0%
313	103.6%	98.0%
323	106.2%	96.9%
335	109.5%	95.9%

The highlighted current values are available as Rsets as a part of the system.

Flux and Efficacy Versus Temperature at Tc (at Nominal Current) 1100lm L9

Tc (°C)	Flux (lm)	Efficacy (lm/W)
65	103.6%	103.1%
75	101.8%	101.1%
85	100.0%	100.00%

Please ensure that while tuning the product's operating point, it stays within limits of temperature (Tc) and current (I) that are covered within the warranty window.

Flux and Efficacy Versus Current (at Nominal Temperature) 1100lm L13

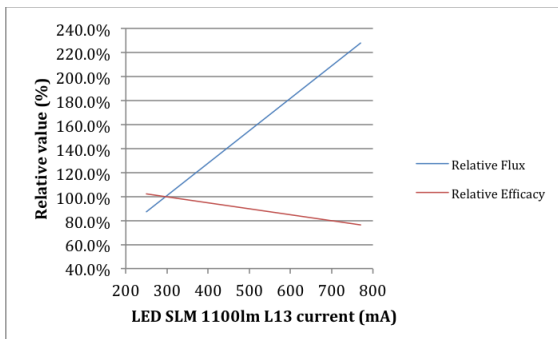

I [A]	Rel flux	Rel effic
250	84.9%	103.3%
270	90.9%	101.6%
292	97.8%	100.8%
300	100.0%	100.0%
323	107.0%	98.4%
368	120.2%	95.9%
387	125.5%	95.1%
436	139.5%	92.6%
485	152.9%	89.3%
500	156.8%	89.3%
536	166.6%	86.9%
602	183.1%	84.4%
669	200.4%	81.1%
724	214.0%	79.5%
750	220.1%	77.9%
770	227.3%	77.0%

The highlighted current values are available as Rsets as a part of the system.

Flux and Efficacy Versus Temperature at Tc (at Nominal Current) 1100lm L13

Tc (°C)	Flux (lm)	Efficacy (lm/W)
65	104.0%	103.2%
75	102.1%	101.6%
85	100.0%	100.0%

Please ensure that while tuning the product's operating point, it stays within limits of temperature (Tc) and current (I) that are covered within the warranty window.

Fortimo LED SLM Gen 4 Crisp White

Tuning Information

Flux and Efficacy Versus Current (at Nominal Temperature) 2000lm L13

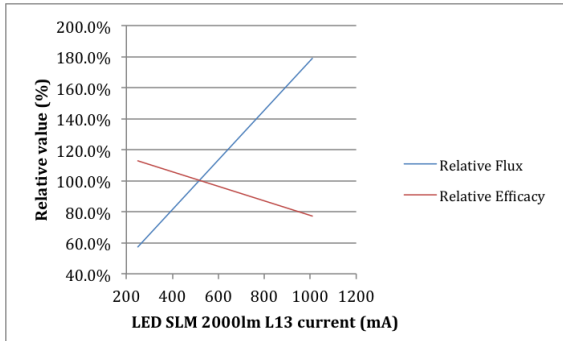

I [A]	Rel flux	Rel effic
250	54.0%	114.5%
270	58.0%	112.8%
292	62.4%	112.0%
300	63.9%	111.1%
323	68.3%	109.4%
368	76.8%	106.8%
387	80.3%	106.0%
436	89.0%	103.4%
485	97.5%	100.9%
500	100.0%	100.0%
536	106.1%	98.3%
669	127.2%	91.5%
750	138.4%	88.9%
853	154.3%	84.6%
950	167.3%	81.2%
1009	175.2%	78.6%

The highlighted current values are available as Rsets as a part of the system.

Flux and Efficacy Versus Temperature at Tc (at Nominal Current) 2000lm L13

Tc (°C)	Flux (lm)	Efficacy (lm/W)
65	104.2%	103.4%
75	102.1%	101.7%
85	100.0%	100.0%

Please ensure that while tuning the product's operating point, it stays within limits of temperature (Tc) and current (I) that are covered within the warranty window.

Flux and Efficacy Versus Current (at Nominal Temperature) 3000lm L15

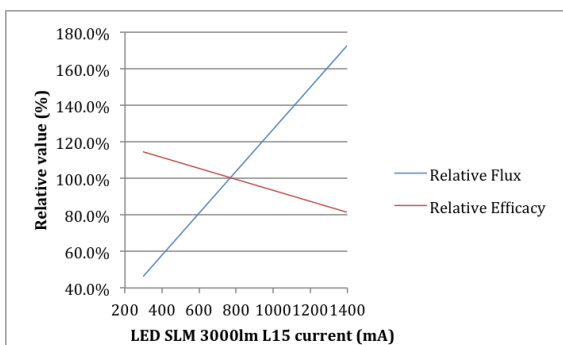

I [A]	Rel flux	Rel effic
300	43.1%	115.8%
387	55.1%	112.3%
436	61.3%	111.4%
485	67.8%	108.8%
500	70.0%	108.8%
536	74.3%	107.0%
669	90.3%	102.6%
750	100.0%	100.0%
853	111.9%	97.4%
916	118.6%	95.6%
950	122.5%	93.9%
968	123.5%	93.9%
1009	129.1%	93.0%
1200	148.6%	87.7%
1400	169.3%	83.3%

The highlighted current values are available as Rsets as a part of the system.

Flux and Efficacy Versus Temperature at Tc (at Nominal Current) 3000lm L15

Tc (°C)	Flux (lm)	Efficacy (lm/W)
65	104.1%	103.5%
75	102.1%	101.7%
85	100.0%	100.0%

Please ensure that while tuning the product's operating point, it stays within limits of temperature (Tc) and current (I) that are covered within the warranty window.

Fortimo LED SLM Gen 4 Crisp White

Tuning Information

Flux and Efficacy Versus Current (at Nominal Temperature) 3800lm L19

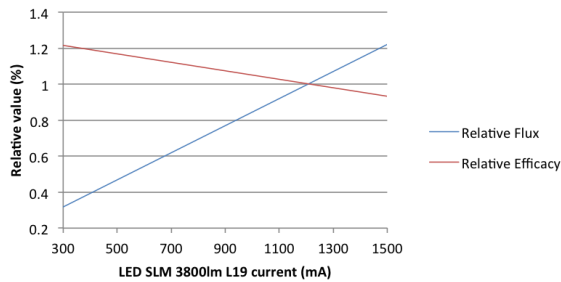

I [A]	Rel flux	Rel effic
300	27.8%	124.3%
500	45.9%	118.3%
669	59.7%	113.0%
750	66.1%	111.3%
853	74.2%	108.7%
916	79.2%	107.0%
950	79.5%	106.1%
968	82.4%	105.2%
1009	86.0%	104.3%
1200	100.0%	100.0%
1231	102.1%	99.1%
1335	109.5%	96.5%
1403	114.3%	95.7%
1500	120.8%	93.0%

The highlighted current values are available as Rsets as a part of the system.

Flux and Efficacy Versus Temperature at Tc (at Nominal Current) 3800lm L19

Tc (°C)	Flux (lm)	Efficacy (lm/W)
65	104.1%	102.5%
75	102.1%	101.6%
85	100.0%	100.0%

Please ensure that while tuning the product's operating point, it stays within limits of temperature (Tc) and current (I) that are covered within the warranty window.

Fortimo LED SLM Gen 4 Crisp White

Warranty Windows

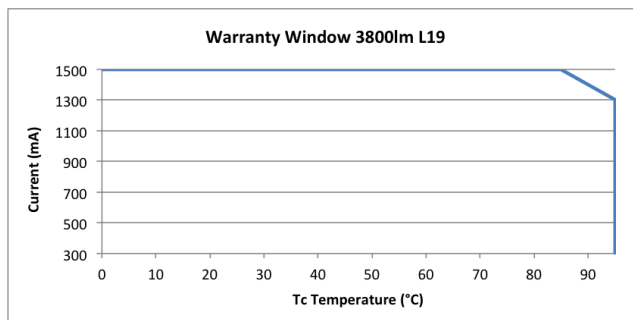
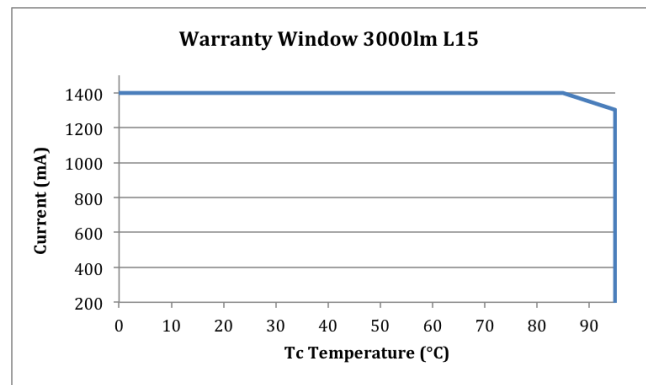
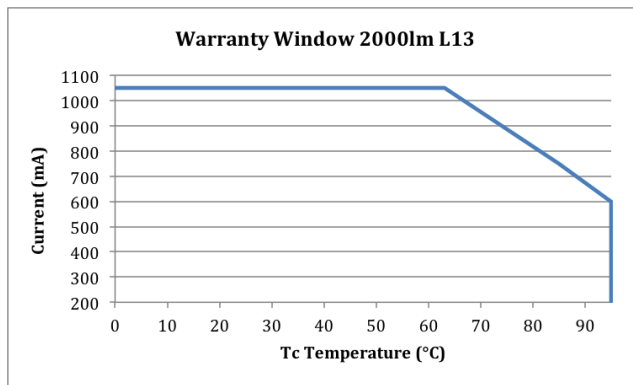
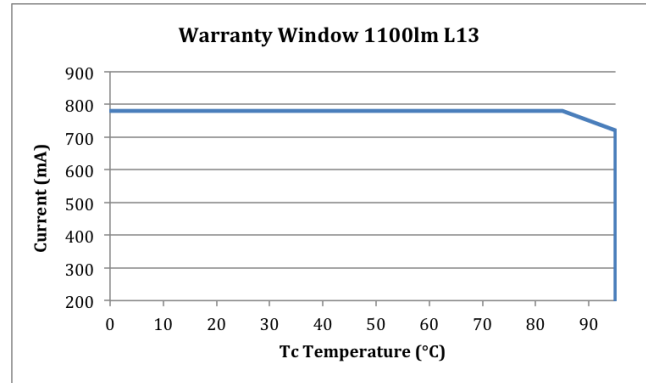
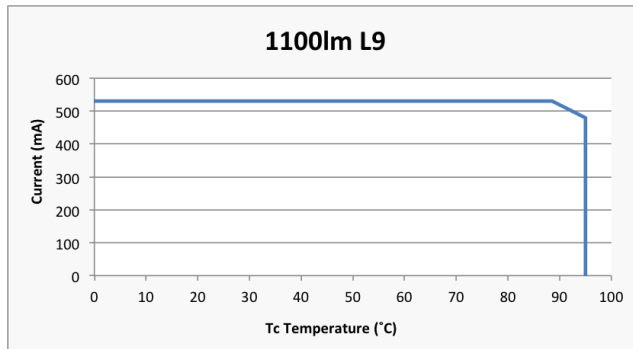

Fortimo LED SLM Gen 4 Crisp White

Lumen Maintenance

Fortimo LED SLM 1100lm L9

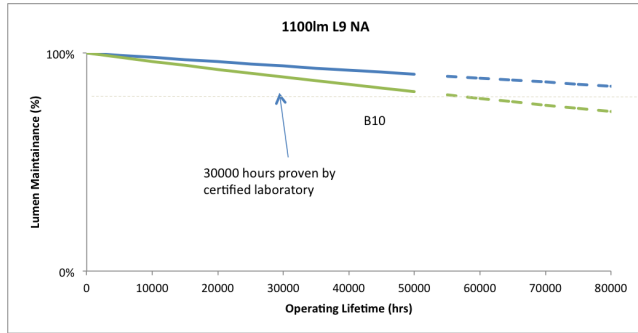

Fortimo LED SLM 1100lm L13

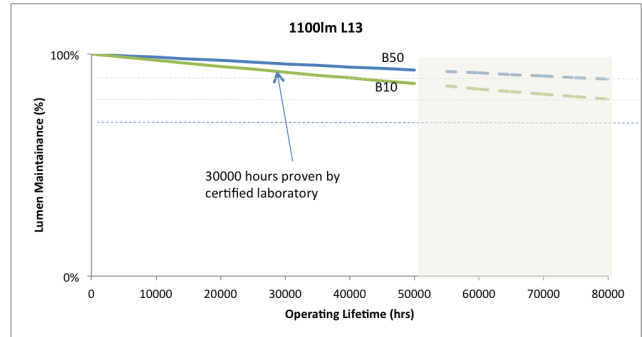

Fortimo LED SLM 2000lm L13

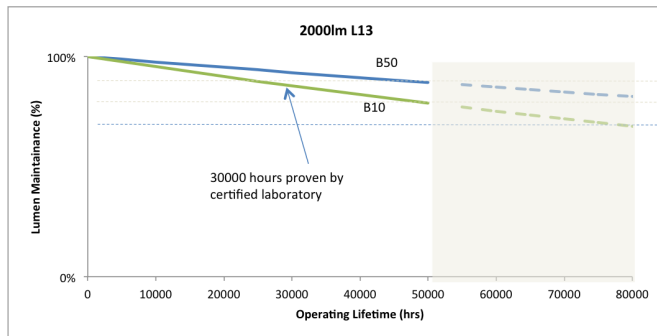

Fortimo LED SLM 3000lm L15

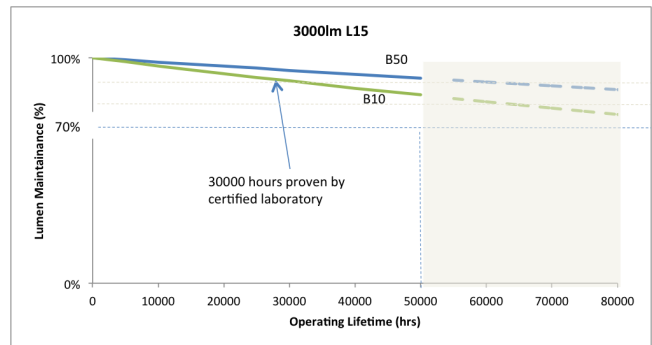

Fortimo LED SLM 3800lm L19

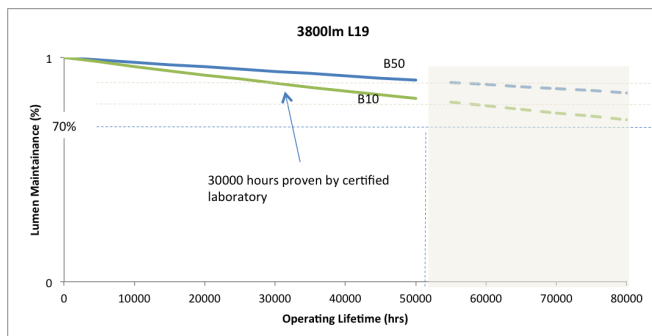

Fortimo LED SLM Gen 4 Crisp White

Lumen Maintenance (B50) Fortimo LED SLM 1100lm L9

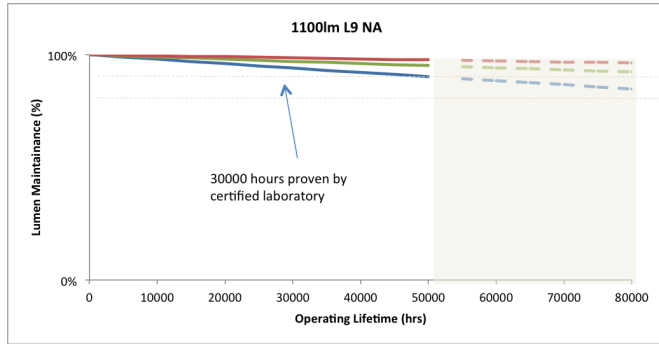

Fortimo LED SLM 1100lm L13

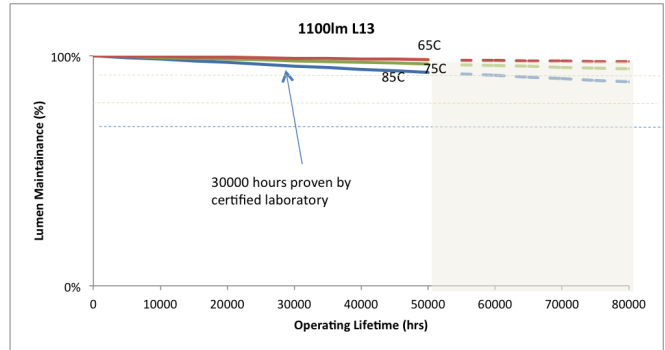

Fortimo LED SLM 2000lm L13

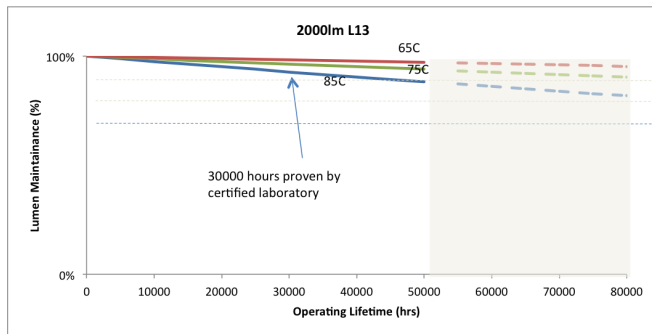

Fortimo LED SLM 3000lm L15

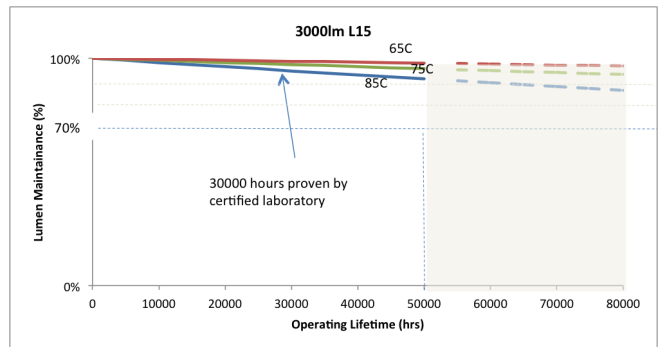

Fortimo LED SLM 3800lm L19

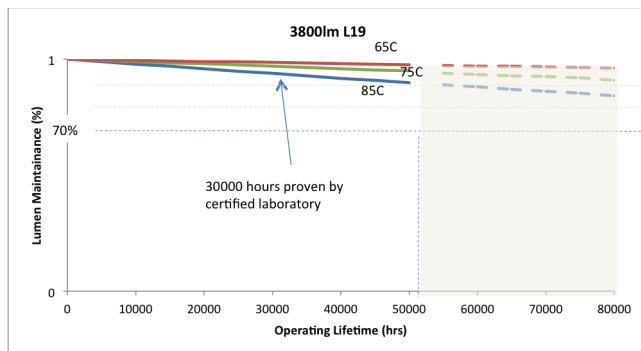

Fortimo LED SLM Gen 4 Crisp White



Measurements showing compliancy to Zhaga book 3 version 1.2 have been done on the 7000lm L23 module.

© 2015 Koninklijke Philips N.V. All rights reserved.
Philips reserves the right to make changes in specifications and/or to discontinue any product at any time without notice or obligation and will not be liable for any consequences resulting from the use of this publication.
philips.com/leddrivers



Philips Lighting North America Corporation
10275 W. Higgins Road, Rosemont IL 60018
Tel: 800-322-2086 Fax: 888-423-1882
Customer/Technical Service: 800-372-3331
OEM Support: 866-915-5886

Imported by: Philips Lighting
A division of Philips Electronics Ltd.
281 Hillmount Rd, Markham, ON, Canada L6C 2S3
Tel. 800-668-9008