



Fortimo LED Line Gen2 Module

Fortimo LED Line 2ft 2200 lm 1R LV2

Fortimo LED Line Gen 2 systems are designed to replace conventional lighting in both fixed and dimmable luminaires. This latest generation is characterized by breakthrough high energy efficiency levels, up to 140 lm/W. Fortimo LED Line systems also offer high quality white light in terms of color rendition and color consistency and are part of the Fortimo future proof promise. The Fortimo LED Line 1R system has been designed with higher lumen output which makes it a better choice for higher ceiling applications. This enables the use of a wide variety of optics resulting in beams ranging from batwing to tight beam distribution, making it the better choice for the illumination of vertical surfaces or areas where high lighting levels are desired.

Benefits

- Increased energy efficiency
- Improved luminaire manufacturability
- Improved temperature management
- Applicable for all fluorescent luminaires
- Systems with Xitanium drivers
- 5-year limited warranty

Features

- Module efficiency up to 140 lm/W
- Introduction of push-in connectors increasing flexibility and enabling usage of bulk wiring and automated wiring
- High quality of white light

Applications

- General lighting applications in office, retail, industry
- 1R is ideal for applications requiring beam shaping



PHILIPS

Commercial product name	12NC
Fortimo LEDline 2ft 2200lm 830 1R LV2	9290 008 80706
Fortimo LEDline 2ft 2200lm 835 1R LV2	9290 008 80806
Fortimo LEDline 2ft 2200lm 840 1R LV2	9290 008 80906
Fortimo LEDline 2ft 2200lm 850 1R LV2	9290 008 81006

Optical characteristics - table per CCT^{1,2}

Fortimo LED line 2ft 2200lm 830 1R LV2

Parameter	Min	Approx.	Max	Unit
Luminous flux ²	1975	2135	2295	lm
Module efficiency	120	132	143	lm/W
Correlated color temperature (CCT) ³		3000		K
Correlated color temperature (CCT) ⁴		3070		K
Color coordinates (CIEx, CIEy) Color coordinates (CIEx, CIEy)		(0.432, 0.402)		-
Color consistency ⁵			3.5	SDCM
CRI	80			-
Radiation angle		120		deg

Fortimo LED line 2ft 2200lm 835 1R LV2

Parameter	Min	Approx.	Max	Unit
Luminous flux ²	2015	2180	2345	lm
Module efficiency	122	134	145	lm/W
Correlated color temperature (CCT) ³		3500		K
Correlated color temperature (CCT) ⁴		3490		K
Color coordinates (CIEx, CIEy)		(0.405, 0.390)		-
Color consistency ⁵			3.5	SDCM
CRI	80			-
Radiation angle		120		deg

Note: Tc nom = 45 °C I nom = 500 mA

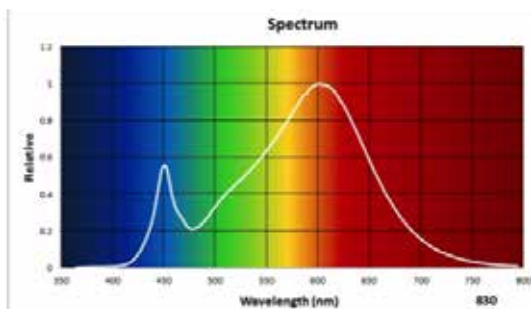

3000K

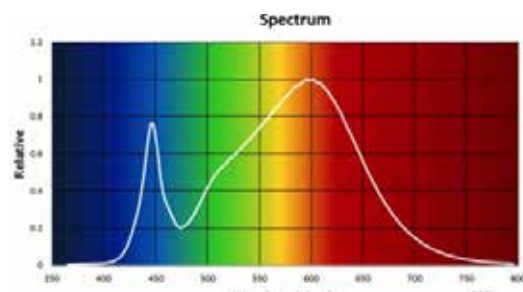

3500K

Fortimo LED line 2ft 2200lm 840 1R LV2

Parameter	Min	Approx.	Max	Unit
Luminous flux ²	2060	2225	2395	lm
Module efficiency	125	137	149	lm/W
Correlated color temperature (CCT) ³		4000		K
Correlated color temperature (CCT) ⁴		4030		K
Color coordinates (CIEx, CIEy)		(0.380, 0.377)		-
Color consistency ⁵			3.5	SDCM
CRI	80			-
Radiation angle		120		deg

Fortimo LED line 2ft 2200lm 850 1R LV2

Parameter	Min	Approx.	Max	Unit
Luminous flux ²	2095	2265	2435	lm
Module efficiency	127	140	152	lm/W
Correlated color temperature (CCT) ³		5000		K
Correlated color temperature (CCT) ⁴		5110		K
Color coordinates (CIEx, CIEy)		(0.342, 0.352)		-
Color consistency ⁵			3.5	SDCM
CRI	80			-
Radiation angle		120		deg

Note: Tc nom = 45 °C I nom = 500 mA

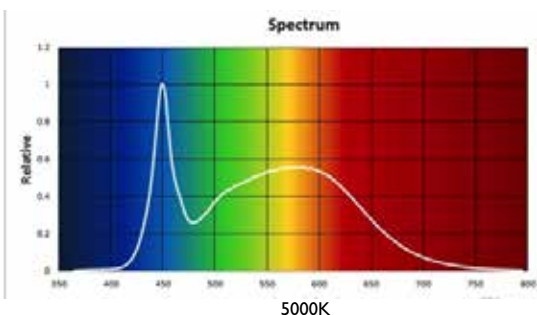
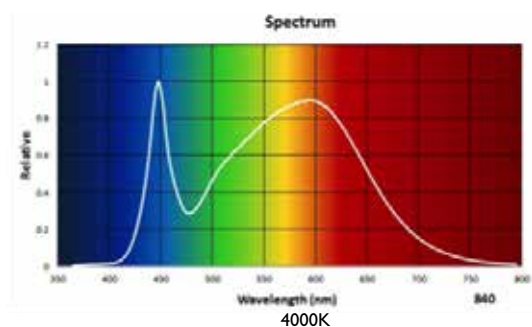

Beam shape

The Philips Fortimo LED Line generates a Lambertian beam shape, which is a pragmatic starting point for OEMs wishing to design secondary optics.

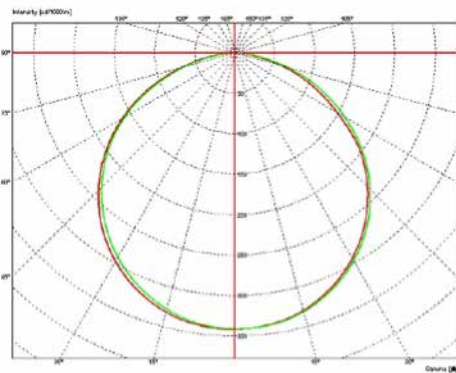

1, 2, 3, 4, 5, can be found on page 6

Electrical characteristics

Parameter	Min	Typ	Max	Unit
Forward voltage	30.9	32.4	33.9	V
Power consumption	15.4	16.2	17.0	W
Minimum dimming for performance	10			%
Number of parallel modules per chain			2	
Bins		2 (E and F)		

Note: Tc nom = 45 °C I nom = 500 mA

Lifetime

Parameter	Min	Typ	Max	Unit
Lumen maintenance B50L70	50000			hrs
$\Delta u/v$ at 6,000 hours			0.007	-
Critical failures		no spec known		%

Note: Tc < 70 °C, I < 600 mA

Parameter	Nominal ⁷	Life ⁸	Max ⁹
Tc [°C]	45	70	80
Current [mA]	500	600	700

Performance at I life and Tc life	Flux [lm]	Efficiency [lm/W]
3000K	2390	124
3500K	2440	126
4000K	2490	128
5000K	2535	131

Abs max ratings

Parameter	Min	Typ	Max	Unit
Current Imax			700	mA
Case temperature Tc max			80	°C
ESD (direct contact)			8	kV
ESD (air)			15	kV
Isolation breakdown voltage	500			Vdc
Ambient temperature	-20			°C

6, 7, 8, 9. can be found on page 6

Wiring

Specification item	Value	Unit	Condition
Input wire cross-section	0.2...0.75	mm ²	solid and fine stranded
	18...24	AWG	
Input wire strip length	6...7	mm	
Tested cable length*	4000	mm	Total length of wiring including LED modules, one way

* Note: connector suited for robot wiring

Mechanical characteristics

Parameter	Min	Typ	Max	Unit
Length	560.4	560.7	561	mm
Width	39.8	40	40.6	mm
Height excl. connector	1.5	1.65	1.8	mm
Height incl. connector	5.65	6	6.35	mm
Warpage (IPC-TM-650)			4.2	mm

Note: Bow & Twist of the PCB after production tested and released according IPC-TM-650 2.4.22

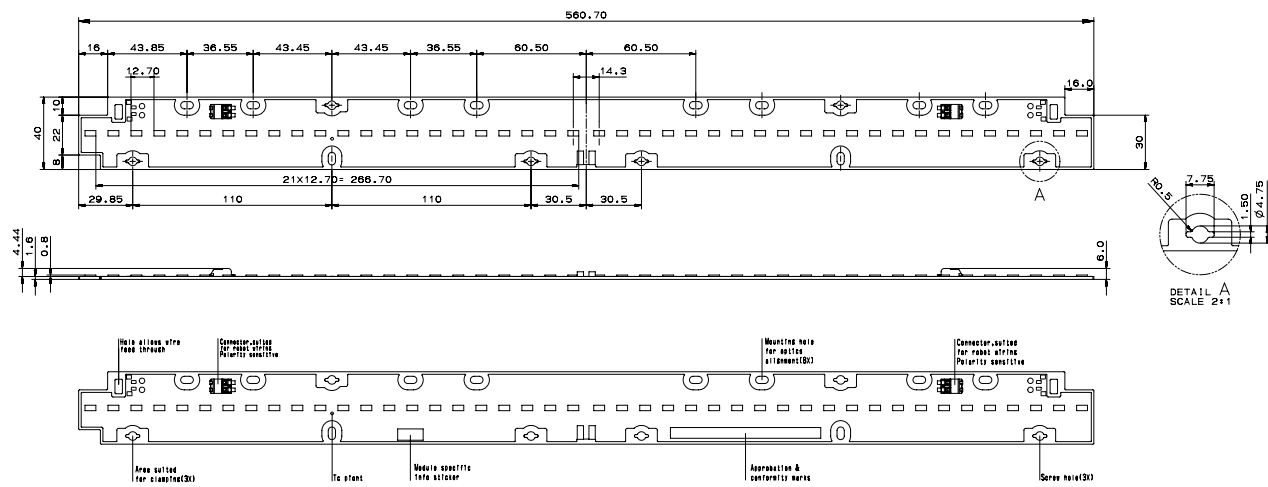

Application information

Compliance and approval

IEC / EN 62031, IEC / EN 62471



Environmental

REACH



Application information

IP rating	IP20
Overheating protection	No protection
Luminaire class	NA

1. Current specifications are subject to change, for the latest specifications, please contact your local Philips sales representative.
2. Photometric testing consistent with CIE 127:2007 2nd Edition
3. CCT for characterisation. Complies with ANSIC78.377A Specifications
4. CCT of Target Color Point
5. Production units will fall between +/- 0.2 of listed value. Note: 3.5 SDCM color consistency specification may not be sufficient for applications that are sensitive to color differences like wall washers, which typically require 2 SDCM.
6. Average rated life is based on engineering data testing and probability analysis. The hours are at the B50, L70 point - 50,000 hours life with 70% lumen maintenance at Tc point of 56° C for 3R and 61° C for 1R
7. Nominal value at which performance is specified
8. Value at which lifetime is specified
9. Maximum value for safety
10. Philips Fortimo _____ Module is a Zhaga certified light engine. For more information visit www.zhagastandard.org
11. Indicates that the LEDs are components recognized with UL and complies with UL8750 Standard for LEDs
12. Restrictions on Hazardous Substances (RoHS) is a European directive (2002/95/EC) designed to limit the content of 6 substances [lead, mercury, cadmium, hexavalent chromium, polybrominated biphenyls (PBB), and polybrominated diphenyl ethers (PBDE)] in electrical and electronic products. For products used in North America compliance to RoHS is voluntary and self-certified

Tuning information

Flux and efficacy versus current

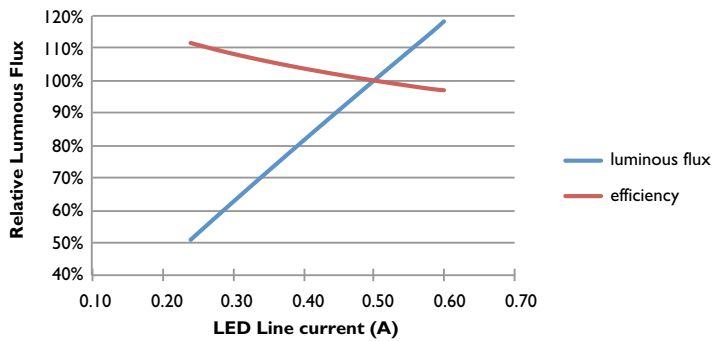

Flux and efficacy versus temperature at Tc

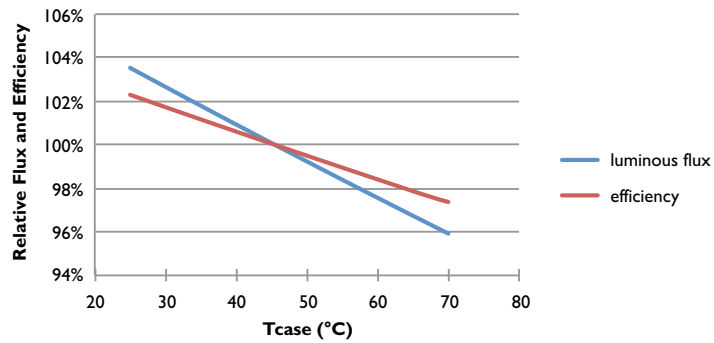

Lumen maintenance

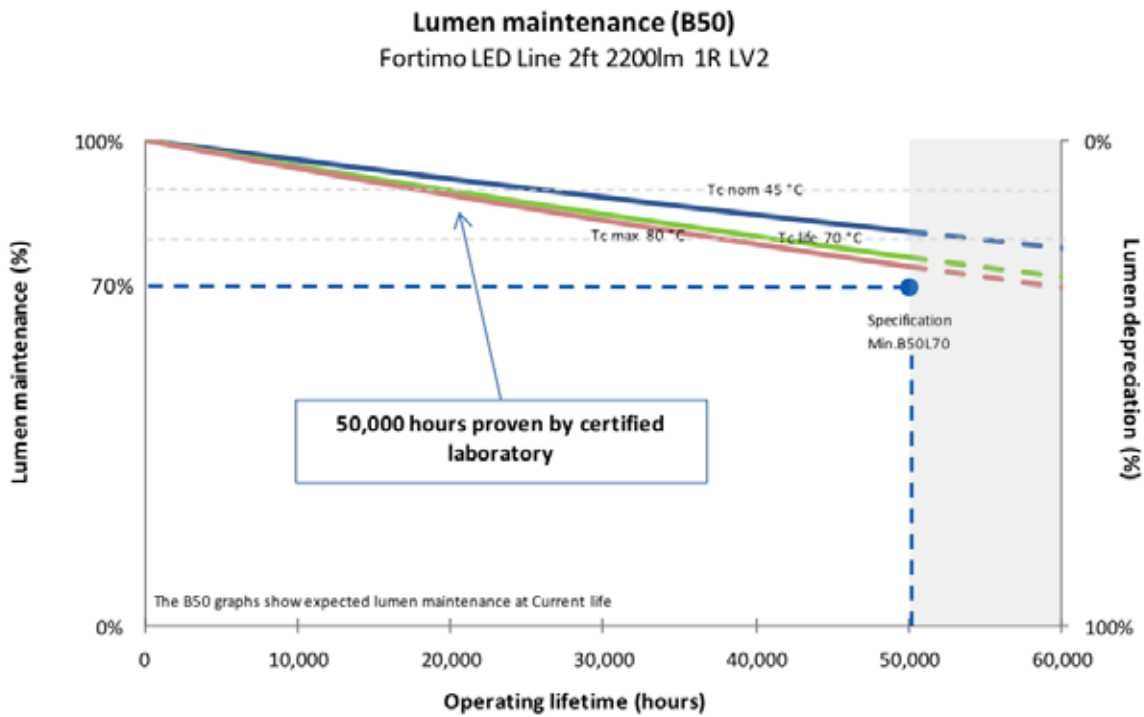

© 2013 Koninklijke Philips N.V.
All rights reserved.
Specifications are subject to change without notice.

LE-6003-A 10/13

Philips Lighting Company
A Division of Philips North America
10275 W. Higgins Road
Rosemont, IL 60018
Tel: 800-322-2086
Fax: 888-423-1882
Customer Support/Customer Care: 800-372-3331
www.philips.com/ledmodulesna