

PHILIPS
HABCO

Landscape

LED lighting



Enjoy perfect light
that **saves energy**

Professional LED Lighting Specification Guide

Experience

The new speed of light

Since 1953, Philips Hadco has built products to a superior standard of quality and craftsmanship using only the finest raw materials and components available. We've built our business to a higher standard and focus on consistency and reliability in every product we develop. We inspect everything we manufacture multiple times, for fit and finish. Each of our designs is precision engineered and backed by ISO 9001 certification. Our comprehensive warranty exceeds industry standards.

This alone doesn't explain how we became the industry leader. There's another important area where we excel.

Service: Smart, Prompt, and Flexible.

At Philips Hadco, we provide a broad selection of styles, finishes, and lamping options in the industry. Our expertise in service helps you navigate through the choices and ensures that you receive what you need, when you need it; even if it requires a custom design. When you choose Philips Hadco, for your landscape lighting needs, we work to assure your lighting project will be on time. That's why more architects and designers depend on Philips Hadco every year, because they know what they'll get – Satisfaction.



Contents

Quick references	2
Visual indexes	2
Applications	6
Mountings & Sizes	10
Finishes & Materials	12
LED Low Voltage	14
Accent lighting	16
Wall Wash lighting	21
Flood lighting	22
Down lighting	23
In-ground lighting	25
Deck lighting	27
Path and walkway lighting	28
Underwater lighting	34
Transformers & Accessories	35
LED Line Voltage	36
Accent lighting	38
Flood lighting	42
Step and Aisle lighting	43
In-ground lighting	46
Bollard lighting	58
Residential lighting	60
Installation processes	64
Indexes	72

LED Low Voltage



What is an LED?

Simply put, an LED, or Light Emitting Diode, is a diode that is chip-mounted in a reflector cup and held in place by a milled steel frame connected to a pair of electrical wires.

When current flows across the junction of the two different materials, light is produced from within the solid crystal chip. Philips Hadco uses bright white LEDs as standard, which are developed by coating a blue LED with a phosphor, and thereby generating a white color.

Why use LED?

- LEDs provide a longevity that is up to 20 times that of standard incandescent lamps, translating to low maintenance.
- LEDs are solid-state devices, meaning no moving parts, glass or filaments to break.
- LEDs are small in size and resistant to vibration or shock.
- LEDs contain no mercury and are environmentally friendly.
- LEDs are more efficient, using up to 90% less energy than other light sources based on watts.

Accent lighting

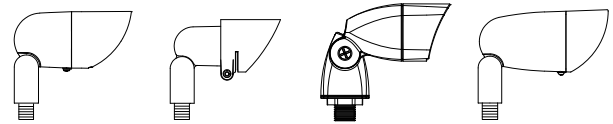

BL5016
pg. 16

BL616
pg. 16

BL9
pg. 17

BUL16
pg. 18

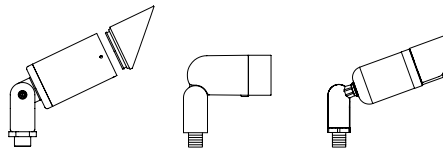

MA5
pg. 18

BL711
pg. 19

BL16
pg. 20

Wall Wash lighting

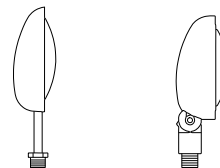

AAL1D
pg. 21

AUL1D
pg. 21

LED Low Voltage

Flood lighting

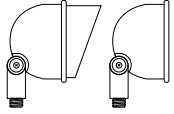

WAML1D/WBML1D
pg. 22

Down lighting

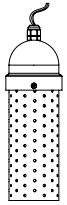

DL1D
pg. 23

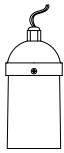

DRL1
pg. 23



DRL1D
pg. 24

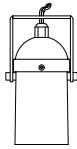

DRL2
pg. 24

In-ground lighting

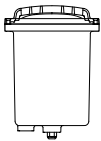

iL116
pg. 25



iUL516
pg. 25

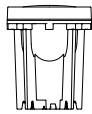

iL9
pg. 26

Deck lighting

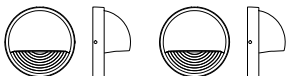

DAL1
pg. 27

DCL1/DUL1
pg. 27

Path and walkway lighting



AL41
pg. 28

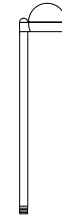

CPL21
pg. 29



CUL2D
pg. 29

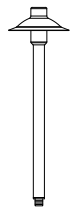

CUL7D
pg. 30

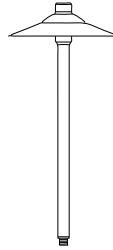

CUL9D
pg. 30

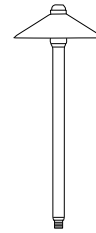

CUL10D
pg. 31



CUL14D
pg. 31

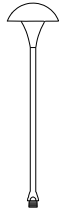

MUL4
pg. 32

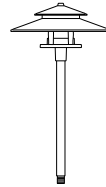

RL4
pg. 32

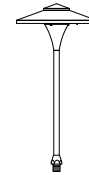

RL9
pg. 33

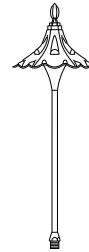

TRL4
pg. 33

Underwater lighting

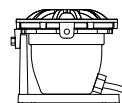

UWL1075
pg. 34

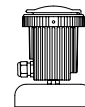

UWUL516
pg. 34

LED Line Voltage



What is an LED?

Simply put, an LED, or Light Emitting Diode, is a diode that is chip-mounted in a reflector cup and held in place by a milled steel frame connected to a pair of electrical wires.

When current flows across the junction of the two different materials, light is produced from within the solid crystal chip. Philips Hadco uses bright white LEDs as standard, which are developed by coating a blue LED with a phosphor, and thereby generating a white color.

Why use LED?

- LEDs provide a longevity that is up to 20 times that of standard incandescent lamps, translating to low maintenance.
- LEDs are solid-state devices, meaning no moving parts, glass or filaments to break.
- LEDs are small in size and resistant to vibration or shock.
- LEDs contain no mercury and are environmentally friendly.
- LEDs are more efficient, using up to 90% less energy than other light sources based on watts.

Accent lighting

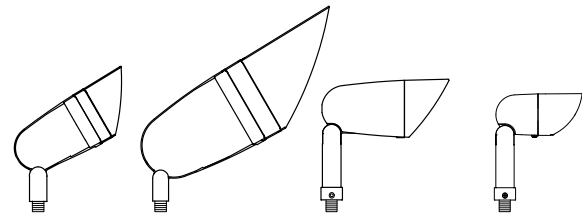

B1
pg. 38

B4
pg. 38

BT1
pg. 39

BT5016
pg. 40

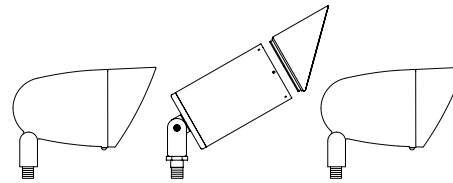

BU3
pg. 40

MA3
pg. 41

B3
pg. 41

Flood lighting

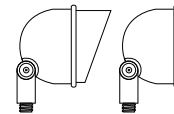

WAM1D/WBM1D
pg. 42

LED Line Voltage

Step and Aisle lighting

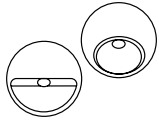

96 Line
(round)
pg. 43

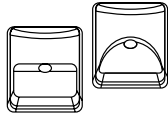

96 Line
(square)
pg. 43

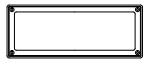

RSF2
pg. 44

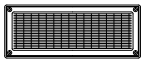

RSS2
pg. 44

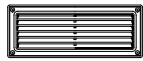

RSC2
pg. 44

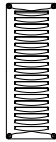

RSV2
pg. 44

In-ground lighting

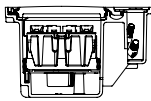

i1.5
pg. 47

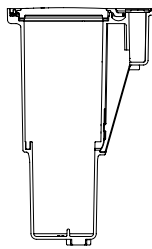

i2.5
pg. 48

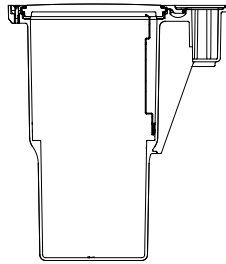

i3.5
pg. 49

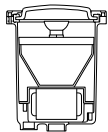

iT216
pg. 50

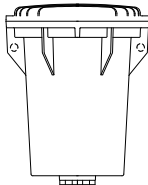

i3
pg. 51



SL23
pg. 52

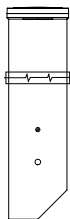

SL25
pg. 53

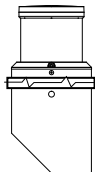

SL33
pg. 54

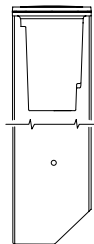

SL34
pg. 55

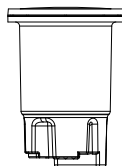

SL43
pg. 56

Bollard lighting

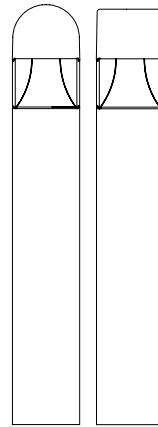

RD6/RF6
pg. 58

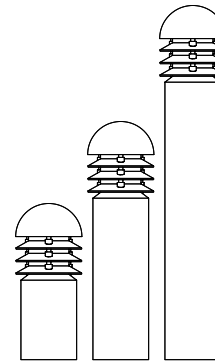

DB14/DB21/DB30
pg. 59

Residential lighting



Palermo
(medium)
pg. 60



Palermo
(large)
pg. 60



Riviera
(medium)
pg. 61



Manor
(medium)
pg. 61

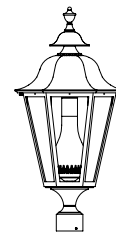

Manor
(large)
pg. 62

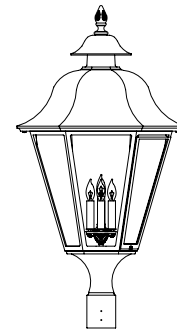

Manor
(extra large)
pg. 62

Applications

Trees, statues, pools, walkways; what features make up your landscape project? Which elements in an environment should be highlighted, and which should be down-played? The answers to those questions will determine the lighting fixtures and techniques you'll ultimately use.

Lighting Styles

- Accent lighting is lighting that focuses attention on a particular object or area. It commands the viewer to take note of a certain subject within the landscape. Examples of accent lighting are spotlighting a statue, path lighting a walkway or highlighting a flower bed with spread lights.
- Fill-in lighting is background lighting. It ties the overall landscape picture together, creating a comfortable transition from one accented area to another. Some examples may be backlighting a tree, washing a wall or fence, or flooding a row of evergreens with soft light.
- Down lighting may seem more natural because we are accustomed to the light of the sun and moon. In fact, most of the lighting that occurs naturally in life is from above. Office lighting, warehouse lighting, sports lighting, and home lighting are all examples of downlighting techniques. Downlighting is also very efficient in that you get to use all the light.
- Up lighting tends to draw more attention and is often more dramatic. Therefore, it is used for accent lighting purposes more often than downlighting.
- Back lighting is used to silhouette a plant, tree, or structure. Many times the shape of a plant is more interesting than the detail. By gently lighting a wall or fence behind the plant, you identify the shape.

Techniques

There are a variety of lighting techniques that in combination create a beautiful and secure environment for anyone.

For each technique there are fixtures that work better than others. Here are some techniques and the fixtures that best create the desired effects:

Accent lighting



Spot lighting

Effect: Focuses an intense beam of light on a particular subject to showcase focal points.

Tip: It's best not to light focal points uniformly or evenly. This gives the subject a washed out appearance and removes details. Statuary should be lit from overhead when possible. If you must light from the ground, place fixtures further out and aim back at the subject. Two levels of light work well; a spot on the facial features and a flood on the body creates a dramatic presentation.

Recommendation: Bullets, Inground lights



Wall Washing

Effect: Gently illuminates a wall or fence to create a backdrop for the main focal points.

Tip: Avoid bright spots by positioning the fixtures 18" to 24" away from the wall.

Recommendation: Wall-washers, Mini Flood lights



Silhouetting

Effect: Displays a dark image of the subject by lighting a vertical surface behind the subject. Effective technique to show shape, but does not show color or texture of the subject. Accomplishes wall washing at the same time.

Tip: Choose a subject that is close to a wall and place the fixture out of sight behind the subject. Flood beam spreads or wall washers work the best.

Recommendation: Bullets, Wall Washers, Mini Flood lights



Shadowing

Effect: Creates a shadow on a vertical surface by placing the fixture in front of the subject.

Tip: Best on open growth plant material. The closer the fixture to the subject, the larger the shadow will be. General illumination lamps create a better effect, use a T-3 or bayonet base lamp instead of an MR or Par lamp.

Recommendation: Bullets, Wall Washers, Mini Flood lights



Grazing

Effect: Enhances texture of a surface by positioning a fixture close to the surface and aiming the beam upward or downward.

Tip: Try grazing on brick, stone, and stucco walls or any interesting masonry. Wide floods work best on walls or wide surfaces. Place fixtures 6" to 8" from the surface. When up lighting, put as much light as possible on the underside of the eave. This will reflect back a good amount of ambient light, many times sufficient to light sidewalks. Remember to aim the lamp with the horizontal beam pattern parallel to the wall. Don't forget the texture of tree trunks.

Recommendation: Bullets, Ingrounds, Mini Flood lights



Keep in Mind...

Often, it is easier to re-lamp a fixture on the ground rather than one mounted in a tree or on the soffit of a building. However, fixtures placed high and aimed down are less likely to be disturbed to need re-aiming. They also do not get covered by leaves, snow, etc. The decision of which to use is determined by the characteristics and lighting goals of each individual job.

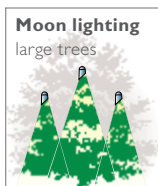

Moon lighting
large trees

Effect: Simulates the light of the full moon filtering through the foliage of a tree. Projects shadows on the ground and lights what is under the tree (paths, sidewalks, flowers, etc.).

Tip: Mount with proper tree mount accessory. Always run wire or conduit up the non-viewing side of the trunk. Best mounting height is approximately 20' and consider composites for their light weight. Aim down as much as possible to prevent glare and mount fixtures in open areas of the foliage to avoid hot spots.

Recommendation: Bullets, Mini Flood lights, Down lights



Moon lighting
small trees

Effect: Down lighting from within the tree, casting shadows, and lighting what is under the tree. Best mounting height no more than 10'.

Tip: For use with smaller ornamental trees to cast light around the base or through the tree.

Recommendation: Down lights, Micro Bullets



Tree lighting
up and down

Effect: Combines simulated full moon light filtering through the tree and up lighting from within to illuminate the canopy. Creates a softer light on the trunk and keeps all fixtures off the ground.

Tip: Mount downlights on tree mount accessory 15' to 25' and use shrouds and/or louvers to reduce glare. Also consider using spread lens to widen the beam of the lamp. Mount uplights in the lowest forks of tree on tree mount accessory. Shrouds and louvers not necessary on uplights. Use wide beam lamps for all fixtures. Run wire up non-viewing side of trunk.

Recommendation: Bullets



Up lighting

Effect: An unnatural, therefore dramatic way of lighting trees and architectural structures. Highlights details on structures and can be used to repeat patterns to create interest.

Tip: For dense foliage trees, place the fixtures outside of the drip line and aim back approximately 45°. Open growth trees can be lit by placing fixtures closer to the trunk. In all cases, get light to the top of the tree. Since a lot of light can be lost with up lighting, take care to aim fixtures so you can recapture the lost light. (Large trees in the background, peaks of structures, eaves to reflect light back). Look for interesting details to highlight on architecture.

Recommendation: Bullets, Mini Flood lights, Inground lights

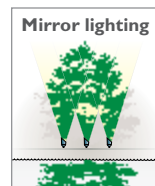

Mirror lighting

Effect: Lights a background scene to reflect it into a nearby body of water.

Tip: Place fixture between water and the scene behind the water. From the primary viewing area, observe what is reflected in the water in the daylight. Then uplight those items to achieve the same view at night. Avoid downlighting (including path lights) around water as the light source will be reflected in the water causing glare.

Recommendation: Bullets, Inground lights

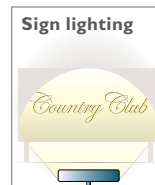

Sign lighting

Effect: Identifies signage after dark: entrances to sub-divisions, country clubs, office complexes, and small shopping centers.

Tip: Choose optics that complement the orientation of the sign. Wide floods for horizontal signs and bullets or ingrounds for vertical signs.

Recommendation: Bullets, Mini Flood lights, Inground lights

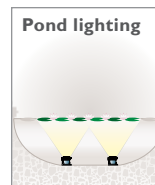

Pond lighting

Effect: Illuminates and identifies water in ponds and water features.

Tip: Water should "look" clean enough to drink. Avoid lighting still, stagnant water with white light. Use colored lenses if water is not clean, or to create different atmospheric effects. Place light fixtures under objects or plant material in the water for interesting effects (lily pads, boulders, art, etc.). For a different approach, light material behind the pond to create the mirror effect and leave the pond dark.

Recommendation: Underwater lights

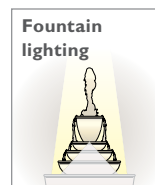

Fountain lighting

Effect: Creates dramatic effects of water movement in fountains and water features while enhancing the structure of the fountain.

Tip: Water must be clean or moving. In most cases it is better to light "through" water than "at" water. Allow the water to fall directly on the fixture. If possible, try lighting tiered bowl fountains from overhead. Otherwise, each bowl should have a fixture in it. Avoid over lighting and lighting evenly around the structure as this tends to wash out the detail.

Recommendation: Bullets, Underwater lights

Applications

In your mind's eye, you've already captured the power and beauty of light. You can rely on Philips Hadco for the broad range of tools you'll need to project that vision.

Quick Tips

- An ice blue lens enhances the colors of evergreen foliage and also "cools off" a halogen lamp like the MR16, giving it the appearance of moonlight.
- When installing low voltage spread lights in a bed of annual flowers, use the S6 adjustable stake so the fixture can be raised as the flowers grow.
- To help conceal the light source, use a cutoff louver such as the ML1 for the BL616 or the ICG16 for the IL116.
- To reduce glare, adjust the shroud on bullets.
- To avoid poisoning trees, use only stainless steel or cadmium-plated steel fasteners when mounting fixtures.
- When attaching low voltage cable to a tree, use a wire tie with a grommet end. This allows the cable to flex slightly off the tree, preventing damage to both.



Security lighting

Light on all walls of the home serves to minimize hiding places for unwelcome visitors.

Up lighting

An ideal place to apply uplighting: Shining skyward toward an area of architectural interest.

Silhouetting

Lighting the wall behind this tree accentuates its interesting shape and branch structure.

Area Lighting



Walkway lighting

Effect: Creates symmetrical patterns of light for illuminating walkways, steps, etc. Used primarily for navigation purposes.

Tip: By lighting only the entrance to a walkway, any turns, and all changes in elevation, you may avoid the runway look and still accomplish the task. Placing fixtures near plant material can create shadows and interest rather than just lighting the hard surface.

Recommendation: Path lights, Spread lights, Beacons

Safety & Security Lighting



Security lighting

Effect: Fills in areas of darkness where intruders could hide. The right combination of low-level lighting in the landscape will improve both security and appearance.

Tip: Effective residential security lighting is not prison yard lighting. The goal is to be able to see movement on the property. This can be accomplished best with lower levels and more sources rather than one or two bright sources (avoid glare).

Recommendation: Bullets, Mini Flood lights, Inground lights, Deck lights, Step lights, Path lights, Spread lights, Beacons



Grazing
The textured beauty of stone masonry becomes a striking feature when grazed with light.

Walkway
The repeated symmetry of this walkway lighting guides visitors while accenting the line of the path in the design, all with minimum glare.

Residential

Shading
This technique allows the designer to paint walls with non-light, generating added dimensions by repeating forms in shadow.

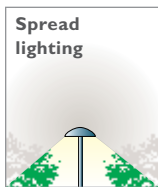

Spread lighting
Effect: Low-level, evenly dispersed illumination to highlight plants, flowers, low shrubs, and ground cover.
Tip: Place shielded fixtures over low plant material, boulders, and plant beds. Partially shielded fixtures may be used in deeper foliage and the additional light will backlight greenery.
Recommendation: Path lights, Spread lights, Beacons, Underwater lights



Down lighting
Effect: Technique of mounting fixtures in trees or on structures. Floods will broadcast light over a wide area creating general ambient light. Spots will dramatically identify focal points. Extremely efficient method of lighting— which means you can often use fewer fixtures. Very natural looking.
Tip: Look for items of interest on the ground that you want to light, then look up for places to mount and conceal fixtures. Select proper beam spreads for what you want to accomplish. Use accessories like spread lenses, louvers, and shrouds to maximize effects and reduce glare.
Recommendation: Bullets, Mini Flood lights, Down lights

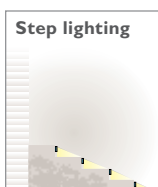

Step lighting
Effect: Lights traffic areas for safety while adding beauty to the steps.
Tip: Every step must be illuminated and visible. Mount fixtures in step risers, underneath railings, or on vertical posts. All changes in elevation and terraces should be lit for safety.
Recommendation: Deck lights, Deck Post lights, Step lights

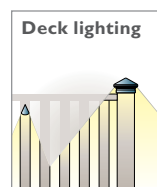

Deck lighting
Effect: Illuminates deck floors and steps while enhancing design.
Tip: Consider placing fixtures under built-in benches for a clean, inconspicuous look. When placing fixtures under handrails, mount fixtures high enough for good light distribution but be careful not to see the source when seated. Run cables under the deck to reduce clutter.
Recommendation: Down lights, Deck lights, Deck Post lights

Mountings & Sizes

Designed to contribute a consistent appearance with complementary style to your home for many years to come. From a distance let your eyes be the judge.

Wall Lighting

With numerous designs to choose from, Philips Hanover Lantern has a style to compliment any architecture. Each series has multiple sizes and mounting options, so you can find the appropriate fixture for your application. With 20 finishes to select from, we can beautifully integrate with your exterior color scheme.

Post Lighting

Philips Hanover Lantern offers an expansive line of posts and designer base wraps to compliment all of our lighting fixtures. Whether you use a single post outside your front entrance, or multiple posts to line your driveway, you will provide security as well as beauty to your property.

Pier Lighting

Create a dramatic entrance to your property with the use of our pier mounted fixtures. Philips Hanover Lantern manufactures a wide range of models and sizes for any application.

Mailboxes & Signs

Add a totally integrated look to your property with the addition of a sign or mailbox. Philips Hanover Lantern offers many standard cast aluminum signs in a variety of shapes and sizes. Our upscale mailboxes, available in your choice of any of our elegant hand applied finishes, are manufactured in a variety of configurations and sizes.



Wall Lighting



Post Lighting



Pier Lighting



Mailboxes & Signs

A fixture size for every application

The entrance to your home or property sets the style and mood of its owners. Choosing a fixture that is properly proportioned to its surroundings is critical. The following series of photographs are used to illustrate this point. Your local lighting showroom can offer expertise in helping you select the correct fixture for your application.



Pier Lighting Manor series is just one of many styles offered in four different sizes. Shown above in a pier mount configuration on a 30" square pier, size and scale of the fixture to its environment is critical. If you have doubts or questions, your local lighting showroom can help determine size.



Post Mount Most home centers offer only smaller sized outdoor lighting fixtures. The Jamestown series fixtures, in the photographs above, clearly illustrate the need for larger scale fixtures. A small size lantern is not recommended for use on a 6' residential post. A 20" high or larger fixture will be more proportional.



Wall Mount Consumers often make the mistake of selecting outdoor lighting fixtures that are too small. South Bend series in the photos above show different size fixtures of the small design in the identical installation. Remember to keep the location of the electrical box in mind for proper height.

* Depicted with 400 pier base mount.

Finishes & Materials

Low & Line Voltage finishes

For LED and Non-LED fixtures.

The proper fit and finish

Some lighting fixtures should be statements unto themselves; others should blend into the environment they serve. A fixture that improperly stands out from its surroundings will distract from the artistry of the application. That's why choosing the right material and finish is just as important as choosing the right lamp.

To maximize your choices, Philips Hadco offers an assortment of materials in a spectrum of finishes, each painstakingly developed to harmonize and endure in naturally occurring environments.

Our ULTEM High-Performance Polymer is a composite material that resists chipping, flaking and fading. Perfect for harsh environments, these composite fixtures are available in Black, Bronze and Verde ... ready to blend into common varieties of soil, mulch or vegetation.

Our die cast aluminum fixtures feature thermoset powder-coat finishes for lasting beauty and durability. In addition to Black, Bronze, Verde and White, other finishes are available for a variety of applications. Garden Green blends into darker vegetation, Sienna matches landscape stone, and Speckled Stone takes it's cues from the color palette of the desert. Each finish makes its own statement of style.

Designed to resemble concrete, our Limestone and Sand Stone finishes are developed with actual aggregate, which is bonded to cast aluminum and sanded for unmatched beauty and durability.

Our spun copper fixtures and cast brass fixtures are natural and will patina over time; or you can choose them pre-aged with oxidized finishes like Antique Copper or Oiled Brass. And for a natural finish that never loses its shine, we offer Stainless Steel.

Don't see your finish here? Don't worry. We have hundreds more standard colors, plus color matching.

Contact your Philips Hadco representative for more details.

Brass

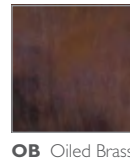

Copper

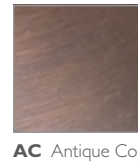
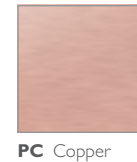

Other



Composite

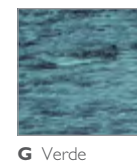
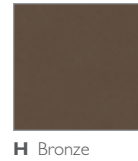
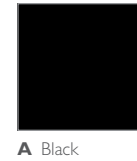

Residential finishes

For LED and Non-LED Residential fixtures only.

Aluminum

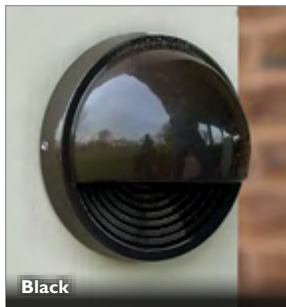

Black



A Black

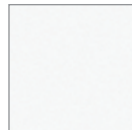

B White



Verde



G Verde



H Bronze



Bronze

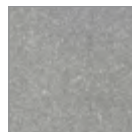

I Grey

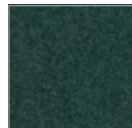

K Garden Green



T Speckled Stone

Finishes



ABS Antique Brass



ACP Antique Copper



ARD Antique Red



ASI Antique Silver



BLK Black



BRZ Bronze



BRN Brown



FGN Forest Green



GRA Granite



IRN Ironstone



RBZ Rustic Bronze



SRT Shadow Rust



VGN Verde



VBZ Verde Bronze



VCP Verde Copper



VTC Vintage Copper



WBZ Weathered Bronze



WHT White

LED Low Voltage

What is an LED?

Simply put, an LED, or Light Emitting Diode, is a diode that is chip-mounted in a reflector cup and held in place by a milled steel frame connected to a pair of electrical wires. When current flows across the junction of the two different materials, light is produced from within the solid crystal chip. Philips Hadco uses bright white LEDs as standard, which are developed by coating a blue LED with a phosphor, and thereby generating a white color.

Why use LED?

- LEDs provide a longevity that is up to 20 times that of standard incandescent lamps, translating to low maintenance.
- LEDs are solid-state devices, meaning no moving parts, glass or filaments to break.
- LEDs are small in size and resistant to vibration or shock.
- LEDs contain no mercury and are environmentally friendly.
- LEDs are more efficient, using up to 90% less energy than other light sources based on watts.





LED Low Voltage

Accent lighting	16
BL5016, BL616, BL9, BUL16, MA5, BL711, CUL16, BL16	
Wall wash lighting	21
AAL1D, AUL1D	
Flood lighting	22
WAML1D/WBML1D	
Down lighting	23
DL1D, DRL1, DRL1D, DRL2	
In-ground lighting	25
iL1116, iUL516, iL9	
Deck lighting	27
DAL1, DCL1/DUL1	
Path and walkway lighting	28
AL41, CPL21, CUL2D, CUL7D, CUL9D, CUL10D, CUL14D, MUL4, RL4, RL9, TRL4	
Underwater lighting	34
UWL1075, UWUL516	
Transformers	35
Mountings & Stakes	35

LED Accent lighting

BL5016

Aluminum Accent



BL5016HS7LED7NFW

- A** Black
- G** Verde
- H** Bronze

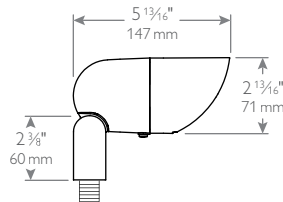

Series	Finish	Mount	Lamp	Optics	CCT
BL5016	<input type="checkbox"/>	S7	<input type="checkbox"/>	<input type="checkbox"/>	<input type="checkbox"/>
BL5016 Aluminum Accent	A Black G Verde H Bronze	S7 Stake	LED7	FL Flood NF Narrow Flood	W Warm

Fixture will be shipped with lamp. Lamp not sold separately.

Features

- 12 Volt
- MR16 LED Lamp
- ½" NPS fitter
- Ships with S7 mounting stake

Housing

Die-cast marine grade aluminum alloy with fully-adjustable swivel arm and vibration-proof locking teeth.

Shroud

Fully-rotatable, double gasketed, die-cast marine grade aluminum alloy.

Finish

Thermoset powder coated in; black, bronze, or hand-rubbed verde antiqued over black.

Optics

Clear tempered glass, affixed at 10° angle for natural cleaning.

LED

- 25,000 hour life (no mercury).
- 7W lamp with 24° or 36° beam spread.
- Color temp (CCT): warm white (3,000K nominal).
- Lamp only sold integral to BL5016.

Wiring

Pre-wired with a 3ft. pigtail for easy hookup to the low voltage supply cable.

Socket

Bi-pin type (GU5.3).

Labels

ETL and cETL listed.

BL616

Aluminum Accent



BL616AS7LED7NFW

- A** Black
- G** Verde
- H** Bronze

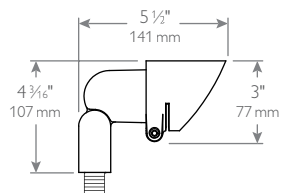

Series	Finish	Mount	Lamp	Optics	CCT
BL616	<input type="checkbox"/>	S7	<input type="checkbox"/>	<input type="checkbox"/>	<input type="checkbox"/>
BL616 Aluminum Accent	A Black G Verde H Bronze	S7 Stake	LED7	FL Flood NF Narrow Flood	W Warm

Fixture will be shipped with lamp. Lamp not sold separately.

Features

- 12 Volt
- MR16 LED Lamp
- ½" NPS fitter
- Ships with S7 mounting stake

Housing

Die-cast aluminum with fully-adjustable swivel arm with vibration-proof locking teeth.

Shroud

Gasketed, cast aluminum.

Finish

Thermoset powder coated in; black, bronze, or hand-rubbed verde antiqued over black.

Optics

Clear tempered glass.

LED

- 25,000 hour life (no mercury).
- 7W lamp with 24° or 36° beam spread.
- Color temp (CCT): warm white (3,000K nominal).
- Lamp only sold integral to BL616.

Wiring

Pre-wired with a 3ft. pigtail for easy hookup to the low voltage supply cable.

Socket

Bi-pin type (GU5.3).

Labels

ETL and cETL listed.

LED Accent lighting

BL9

Aluminum Accent

Series	Lamping	CCT	Finish	Mount
BL9	D			S7
BL9 Low Voltage Bullet lighting	D LED	W Warm (3000K) C Cool (4000K)	A Black H Bronze	S7 Stake

Features

- 12 Volt
- Ships with S7 mounting stake

Housing

A 360° die-cast aluminum housing for driver with thermal management creates continuity with housing by repeating similar shape. All gaskets are 100% molded silicone.

Shroud

A360° die-cast aluminum, tool-less twist off/on.

Finish

Thermoset polyester powder coat is electrostatically applied after a five-stage conversion cleaning process and bonded by heat fusion thermosetting.

Mounting

½"-14 NPSM male threads to screw onto mounting stake, or other mounting accessory, sold separately.

Controls

12 Volt Class 2 driver with integral switch provides simple customer access to the adjustment between 4 present light levels.

Optics

Flat glass, low iron tempered clear glass, c-channel gasket slips onto lens without tools or RTV. Zoomable optic / Injection molded acrylic (PMMA) clear, highly polished molded with select surfaces textured. Zoomable lens provides Narrow 15° to Medium 35° beam pattern depending on the position. Inter-changeable lens provides Wide 60 flood output.

LED

Single Luxeon M LED.

IP66 rating

Dust tight and sealed against direct jets of water.

Labels

ETL Listed to U.S. safety standards for wet locations. cETL listed to Canadian safety standards for wet locations. Manufactured to ISO 9001:2008 Standards 5-year limited warranty.



- A** Black
- H** Bronze

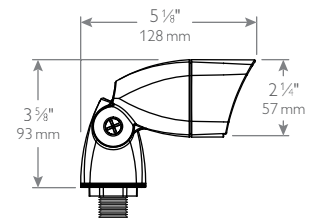

BL9 shown in photograph

LED Accent lighting

BUL16

Composite Accent



BUL16HS7LED7NFW

- A** Black
- G** Verde
- H** Bronze

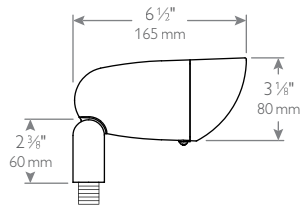

Series	Finish	Mount	Lamp	Optics	CCT
BUL16	<input type="checkbox"/>	S7	LED7	<input type="checkbox"/>	W
BUL16 Composite Accent	A Black G Verde H Bronze	S7 Stake	LED7	NF Narrow Flood FL Flood	W Warm

Fixture will be shipped with lamp. Lamp not sold separately.

Features

- 12 Volt
- MR16 LED Lamp
- 1/2" NPS fitter
- Ships with S7 mounting stake

Housing

One-piece injection molded ULTEM High Performance Polymer with fully-adjustable swivel arm and vibration-proof locking teeth.

Shroud

Fully-rotatable, gasketed, ULTEM High Performance Polymer composite.

Finish

Color impregnated material in; black, bronze, or hand-rubbed verde antiqued over black.

Optics

Clear tempered glass affixed at 10° angle for natural cleaning.

LED

- 25,000 hours life (no mercury).
- 7W lamp with 24° or 36° beam spread.
- Color temp (CCT): warm white (3,000K nominal).
- Lamp only sold integral to BUL16.

Wiring

Pre-wired with a 3ft. pigtail for easy hookup to the low voltage supply cable.

Socket

Bi-pin type (GU5.3).

Labels

ETL and cETL listed.

MA5

Aluminum Accent



MA5NFDHWHL S7

- A** Black
- H** Bronze

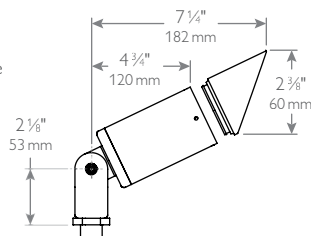

Series	Optics	Source	CCT	Finish	Shroud	Mount
MA5	<input type="checkbox"/>	<input type="checkbox"/>	<input type="checkbox"/>	<input type="checkbox"/>	<input type="checkbox"/>	S7
MA5 Aluminum Accent	SP Spot NF Narrow Flood FL Flood	DL low-output DH high-output	W Warm C Cool	A Black H Bronze	- None L Long 45°	S7 Stake



Features

- 12 Volt
- 6.2 total watts (high power)
- 5.1 total watts (low power)
- 1/2" NPS fitter
- Ships with S7 mounting stake

Housing

Precision machined aluminum from 6061-T6 material. Stainless Steel fasteners.

Shroud

Optional Long 45°

Finish

Thermoset powder coated in; black or bronze.

Optics

- Three beam spread:
- Spot - 23°
 - Medium - 30°
 - Flood - 54°

LED

- 35,000 hours life at 30°C ambient temperature and 70% lumen maintenance.
- Color temp (CCT): 3,000K or 4,000K

Wiring

Pre-wired with a 3ft. pigtail for easy hookup to the low voltage supply cable.

Electrical

Input voltage range (VAC): 10 - 14, regulated to 12V DC.

IP65 rating

Completely dust-tight and sealed to withstand low pressure jets of water from any direction.

Labels

ETL and cETL listed.

LED Accent lighting

BL711

Aluminum Accent



BL711HS7LED7NFW

- A Black
- H Bronze

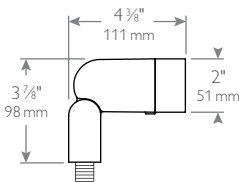

Series	Finish	Mount	Lamp	CCT
BL711	<input type="checkbox"/>	S7	LED2	W
BL711 Composite Accent	A Black H Bronze	S7 Stake	LED2	W Warm

Fixture will be shipped with lamp. Lamp not sold separately.

Features

- 12 Volt
- T3 LED Lamp
- 1/2" NPS fitter
- Ships with S7 mounting stake

Shroud

Gasketed, cast aluminum.

Finish

Thermoset powder coated in black or bronze.

Housing

Die-cast aluminum with fully adjustable swivel arm and vibration proof locking teeth.

Optics

Clear tempered glass affixed at 10° angle for natural cleaning.

LED

- 15,000 hours life (no mercury).
- 2W lamp.
- Color temp (CCT): warm white (3,000K nominal).
- Lamp only sold integral to BL711.

Wiring

Pre-wired with a 3 ft. pigtail for easy hookup to the low voltage supply cable.

Socket

Bi-pin type (G4).

Labels

ETL and cETL listed.

CUL16

Copper Accent



CUL16S7LED7NFW

- Copper

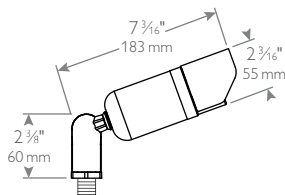

Series	Mount	Lamp	Optics	CCT
CUL16	S7	LED7	<input type="checkbox"/>	W
CUL16 Copper Bullet	S7 Stake	LED7	NF Narrow Flood F Flood	W Warm

Fixture will be shipped with lamp. Lamp not sold separately.

Features

- 12 Volt
- MR16 LED Lamp
- 1/2" NPS fitter
- Ships with S7 mounting stake

Shroud

Fully rotatable.

Finish

Natural copper will age to a fine patina.

Housing

Machined solid copper with fully-adjustable natural brass swivel arm and brass fastener.

Optics

Clear tempered glass.

LED

- 25,000 hours life (no mercury).
- 7W lamp with 24° or 36° beam spread.
- Color temp (CCT): warm white (3,000K nominal).
- Lamp only sold integral to CUL16.

Wiring

Pre-wired with a 3 ft. pigtail for easy hookup to the low voltage supply cable.

Socket

Bi-pin type (G4).

Labels

ETL and cETL listed.

LED Accent lighting

BL16

Composite Accent



BL16HS7LED7NFW

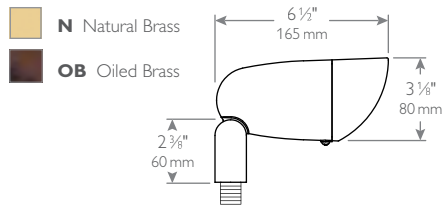

Series	Finish	Mount	Lamp	Optics	CCT
BL16	<input type="checkbox"/>	S7	LED7	<input type="checkbox"/>	W
BL16 Composite Accent	N Natural Brass OB Oiled Brass	S7 Stake	LED7	NF Narrow Flood FL Flood	W Warm

Fixture will be shipped with lamp. Lamp not sold separately.

Features

- 12 Volt
- MR16 LED Lamp
- 1/2" NPS fitter
- Ships with S7 mounting stake

Housing

Die-cast brass with fully-adjustable swivel arm and vibration-proof locking teeth.

Shroud

Fully-rotatable, gasketed, die-cast brass.

Finish

Natural brass or oiled brass. Oiled brass finish is chemically treated and appearance will vary between production runs. Finish will continue to patina over time.

Optics

Clear tempered glass affixed at 10° angle for natural cleaning.

LED

- 25,000 hours life (no mercury).
- 7W lamp with 24° or 36° beam spread.
- Color temp (CCT): warm white (3,000K nominal).
- Lamp only sold integral to BL16.

Wiring

Pre-wired with a 3ft. pigtail for easy hookup to the low voltage supply cable.

Socket

Bi-pin type (GU5.3).

Labels

ETL and cETL listed.



LED Wall Wash lighting

AAL1D

Aluminum Wall Washer

Series	CCT	Finish	Mount
AAL1D	<input type="checkbox"/>	<input type="checkbox"/>	S7
AAL1D Aluminum Wall Washer	C3 Cool (high power) C2 Cool (low power) W3 Warm (high power) W2 Warm (low power)	A Black	S7 Stake

Features

- 12 Volt
- 3.8 total watts (high power)
- 2.4 total watts (low power)
- 1/2" NPS fitter
- Ships with S7 mounting stake

Housing

Cast aluminum construction with fully-adjustable swivel arm with vibration-proof locking teeth.

Finish

Thermoset powder coated in; black.

Optics

Clear polycarbonate lens. 150° LED spread.

LED

- 50,000 hours life at 25°C ambient temperature and 70% lumen maintenance.
- Color temp (CCT): 3,000K or 4,000K

Wiring

Pre-wired with a 3ft. pigtail for easy hookup to the low voltage supply cable.

Electrical

Input voltage range (VAC): 10.8 - 13.2, regulated to 12V DC.

IP66 rating

Completely dust-tight and sealed against direct jets of water.

Labels

ETL and cETL listed.



AAL1DW3AS7

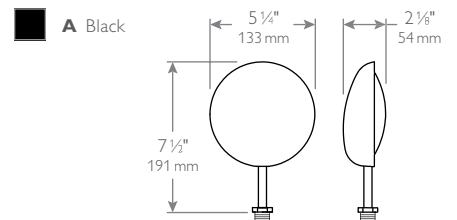

AUL1D

Composite Wall Washer

Series	CCT	Finish	Mount
AAL1D	<input type="checkbox"/>	<input type="checkbox"/>	S7
AAL1D Aluminum Wall Washer	C3 Cool (high power) C2 Cool (low power) W3 Warm (high power) W2 Warm (low power)	G Verde	S7 Stake

Features

- 12 Volt
- 3.8 total watts (high power)
- 2.4 total watts (low power)
- 1/2" NPS fitter
- Ships with S7 mounting stake

Housing

Injection molded ULTEM High Performance Polymer composite with adjustable swivel arm and vibration-proof locking teeth.

Finish

Color impregnated material in black, hand-rubbed verde antiqued over black.

Optics

Clear polycarbonate lens. 150° LED spread.

LED

- 50,000 hours life at 25°C ambient temperature and 70% lumen maintenance.
- Color temp (CCT): 3,000K or 4,000K

Wiring

Pre-wired with a 3ft. pigtail for easy hookup to the low voltage supply cable.

Electrical

Input voltage range (VAC): 10.8 - 13.2, regulated to 12V DC.

IP66 rating

Completely dust-tight and sealed against direct jets of water.

Labels

ETL and cETL listed.



AAL1DW3GS7

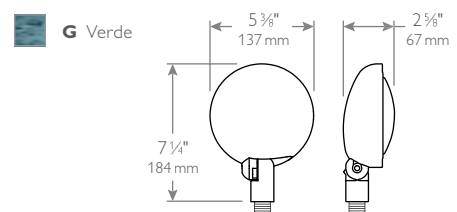

LED Flood lighting

WAML1D/WBML1D

Aluminum Flood light



WAML1DW3-HS7

- A** Black
- B** White
- G** Verde
- H** Bronze

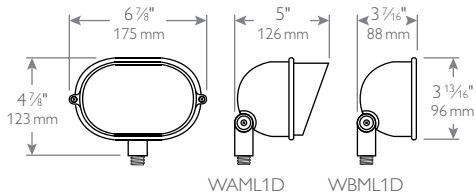

Series	CCT	Lens	Finish	Mount
<input type="checkbox"/>	<input type="checkbox"/>	<input type="checkbox"/>	<input type="checkbox"/>	<input type="checkbox"/> S7
WAML1D Aluminum Spot light with shroud	C3 Cool (high power) C2 Cool (low power)	- Clear Lens F Frosted Lens	A Black B White G Verde H Bronze	S7 Stake
WBML1D Aluminum Spot light without shroud	W3 Warm (high power) W2 Warm (low power)			

Features

- 12 Volt
- 3.8 total watts (high power)
- 2.4 total watts (low power)
- 1/2" NPS fitter
- > 80 CRI
- Ships with S7 mounting stake

Housing

Die-cast aluminum with fully-adjustable swivel arm, with vibration-proof locking teeth.

Shroud

Gasketed, cast aluminum available (WAML1D).

Finish

Thermoset powder coated in; black, white, or hand-rubbed verde antiqued over black.

Optics

Clear or frosted tempered glass. 150° LED spread (equivalent to wide flood).

LED

- 50,000 hours life at 25°C ambient temperature and 70% lumen maintenance.
- Color temp (CCT): cool white (4,000K) or warm white (3,000K)

Wiring

Pre-wired with a 3 ft. pigtail for easy hookup to the low voltage supply cable.

Electrical

Input voltage range (VAC): 10.8 - 13.2, regulated to 12V DC. Integral surge protector (magnetic low voltage transformer required).

IP66 rating

Completely dust-tight and sealed against direct jets of water.

Labels

ETL and cETL listed.



WAML1D shown in photograph

LED Down lighting

DL1D Aluminum Down light

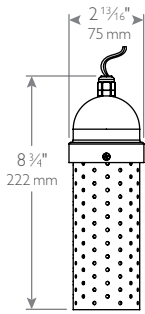

G Verde

Series	CCT	Finish
DL1D	<input type="checkbox"/>	G
DL1D Aluminum Down light	C3 Cool (6.4W) C2 Cool (3.7W) W3 Warm (6.4W) W2 Warm (3.7W)	G Verde

Features

- 12 Volt
- 3.8 total watts (high power)
- 2.4 total watts (low power)

Housing

Cast aluminum top cap with aluminum body and 5 ft. stainless suspension cable.

Finish

Thermoset powder coated in; hand-rubbed verde antiqued over black.

LED

- 50,000 hours life at 25°C ambient temperature and 70% lumen maintenance.
- Color temp (CCT): 3,000K or 4,000K.

Wiring

Pre-wired with a 8 ft. pigtail for easy hookup to the low voltage supply cable.

Electrical

Input voltage range (VAC): 10.8 - 13.2, regulated to 12V DC.

IP66 rating

Completely dust-tight and sealed against direct jets of water.

Labels

ETL and cETL listed.

DRL1 Aluminum Down light

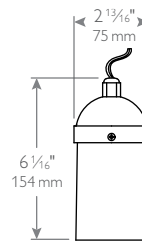

A Black **G** Verde

Series	Finish	Lamp	Optics	CCT
DRL1	<input type="checkbox"/>	LED7	<input type="checkbox"/>	<input type="checkbox"/>
DRL1 Aluminum Down light	A Black G Verde	LED7	FL Flood NF Narrow Flood	W Warm

Fixture will be shipped with lamp. Lamp not sold separately.

Features

- 12 Volt
- MR16 LED Lamp

Housing

Cast aluminum top cap with aluminum body and 5 ft. stainless suspension cable.

Finish

Thermoset powder coated in; black or hand-rubbed verde antiqued over black.

Optics

Clear tempered glass.

LED

- 25,000 hours life (no mercury).
- 7W lamp with 24° or 36° beam spread
- Color temp (CCT): warm white (3,000K nominal).
- Lamp only sold integral to DRL1.

Wiring

Pre-wired with a 8 ft. pigtail for easy hookup to the low voltage supply cable.

Socket

Bi-pin type (GU5.3).

Labels

ETL and cETL listed.

LED Down lighting

DRL1D

Aluminum Down light

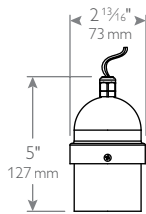

A Black **G** Verde

Series	CCT	Finish
DRL1D	<input type="checkbox"/>	<input type="checkbox"/>
DRL1D Aluminum Down light	C3 Cool (6.4W) C2 Cool (3.7W) W3 Warm (6.4W) W2 Warm (3.7W)	A Black G Verde

Features

- 12 Volt
- 3.8 total watts (high power)
- 2.4 total watts (low power)

Housing

Cast aluminum top cap with aluminum body and 5 ft. stainless suspension cable..

Finish

Thermoset powder coated in; black or hand-rubbed verde antiqued over black.

LED

- 50,000 hours life at 25°C ambient temperature and 70% lumen maintenance.
- Color temp (CCT): 3,000K or 4,000K.

Wiring

Pre-wired with a 8 ft. pigtail for easy hookup to the low voltage supply cable.

Electrical

Input voltage range (VAC): 10.8 - 13.2, regulated to 12V DC.

IP66 rating

Completely dust-tight and sealed against direct jets of water.

Labels

ETL and cETL listed.

DRL2

Aluminum Down light

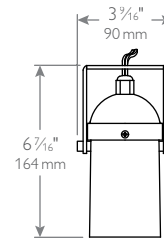

A Black

Series	Finish	Lamp	Optics	CCT
DRL2	<input type="checkbox"/>	<input type="checkbox"/>	<input type="checkbox"/>	<input type="checkbox"/>
DRL2 Aluminum Down light	A Black	LED7	FL Flood NF Narrow Flood	W Warm

Fixture will be shipped with lamp. Lamp not sold separately.

Features

- 12 Volt
- MR16 LED Lamp

Housing

Cast aluminum top cap with aluminum body and adjustable mounting yoke.

Finish

Thermoset powder coated in black.

Optics

Clear tempered glass.

LED

- 25,000 hours life (no mercury).
- 7W lamp with 24° or 36° beam spread
- Color temp (CCT): warm white (3,000K nominal).
- Lamp only sold integral to DRL2.

Wiring

Pre-wired with a 3 ft. pigtail for easy hookup to the low voltage supply cable.

Socket

Bi-pin type (GU5.3).

Labels

ETL and cETL listed.

LED In-ground lighting

iL116 Composite Inground

Series	Rock guard	Finish	Lamp	Optics	CCT
iL116	<input type="checkbox"/>	<input type="checkbox"/>	LED7	<input type="checkbox"/>	<input type="checkbox"/>
iL116 Composite Inground	- None G Guard	N Natural Cast Bronze H Bronze	LED7	NF Narrow Flood FL Flood	W Warm

Fixture will be shipped with lamp. Lamp not sold separately.

Features

- 12 Volt
- MR16 LED Lamp

Housing

Single-piece compression molded, fiberglass reinforced polyester composite housing.

Trim ring

Compression molded polyester or natural cast bronze.

LED

- 25,000 hours life (no mercury).
- 7W lamp with 24° or 36° beam spread.
- Color temp (CCT): warm white (3,000K nominal).
- Lamp only sold integral to iL116.

Optics

Clear convex, tempered soda-lime glass for high impact resistance. 2,200-pound live-load rated, standard walkover.

Rock guard

Optional rock guard is directional for glare control. Compression molded polyester

Wiring

Pre-wired with 3 ft. pigtail for easy hookup to the low voltage supply cable.

Aiming

15° either side of vertical and full 360° rotation. Angle degree marks for precise vertical aiming.

IP66/68 rating

Dust-tight and dual rated – sealed against direct jets of water and against continuous immersion up to a depth of 1 meter (3.28 feet).

Labels

ETL and cETL listed.

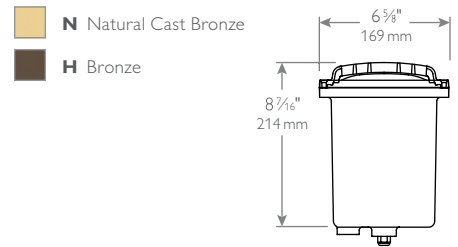

Series	Finish	Lamp	Optics	CCT
iUL516	H	LED7	<input type="checkbox"/>	W
iUL516 Composite Inground	H Bronze	LED7	NF Narrow Flood FL Flood	W Warm

Fixture will be shipped with lamp. Lamp not sold separately.

Features

- 12 Volt
- MR16 LED Lamp

Housing

Single-piece injection molded fiberglass reinforced ULTEM High Performance Polymer.

Finish

Color impregnated composite material in; bronze.

Optics

Convex lens is clear, high temperature tempered glass furnished with silicone O-ring for watertight seal.

LED

- 25,000 hours life (no mercury).
- 7W lamp with 24° or 36° beam spread.
- Color temp (CCT): warm white (3,000K nominal).
- Lamp only sold integral to iUL516.

Wiring

Pre-wired with a 3 ft. pigtail for easy hookup to the low voltage supply cable.

Socket

Bi-pin type (GU5.3).

Labels

ETL and cETL listed.

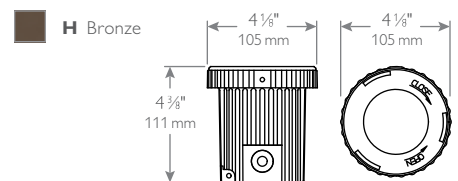

LED In-ground lighting

iL9

Composite Inground



iL9DWA

A Black

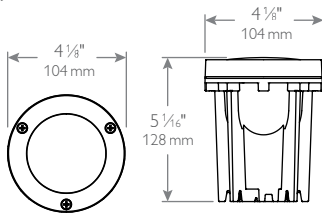

Series	Lamping	CCT	CCT
iL9	D	<input type="checkbox"/>	A
iL9 Low Voltage Inground lighting	D LED	W Warm (3000K) C Cool (4000K)	A Black

Features

- 12 Volt

Housing

Black Injection molded, glass filled polyester, molded-in fins for thermal performance as well as to discourage heaving and twisting after install. Molded-in brass inserts for repeatable opening / closing. Lens ring secured with three (3) screws that clamp lens and gasket into place, flush for ADA compliance and repeatable sealing.

LED

Single Luxeon M LED.

Finish

Composite is textured, pressure formed, black molded-in-color.

Controls

12 Volt Class 2 driver with integral switch provides simple customer access to the adjustment between 4 present light levels.

Optics

Low iron-tempered clear glass, molded gasket slips onto lens without tools or RTV. Zoomable optic / Injection molded acrylic (PMMA) clear, highly polished molded with select surfaces textured. Inter-changeable lens provides Narrow 15° to Medium 35° beam pattern depending on the position, Inter-changeable lens provides Wide 60° flood output.

IP67 rating

Dust-tight and sealed against direct jets of water and against continuous immersion up to a depth of 1 meter (3.28 feet).

Labels

ETL Listed to U.S. safety standards for wet locations. cETL listed to Canadian safety standards for wet locations. Manufactured to ISO 9001:2008 Standards 5-year limited warranty.



iL9 shown in photograph

LED Deck lighting

DAL1

Aluminum or Stainless Steel Deck light

Series	Finish	Lamp	CCT
DAL1		LED2	W
DAL1 Aluminum or Stainless Steel Deck light	A Black B White G Verde H Bronze SS Stainless Steel	LED2 LED	W Warm (3000K)

Fixture will be shipped with lamp. Lamp not sold separately.

Features

- 12 Volt
- T3 LED lamp
- 1.2 total Watts
- >80 CRI

Housing

A, B, G, & H: Cast aluminum construction with stainless steel set screws.
SS: Stainless steel housing with stainless steel set screws.

Finish

A, B, G, & H: Thermoset powder coated in; black, white, bronze, or hand-rubbed verde antiqued over black.
SS: Stainless steel with brushed matte finish.

Optics

Frosted annealed glass.

LED

- 15,000 hours life at 25°C ambient temperature and 70% lumen maintenance.
- Color temp (CCT): warm white (3,000K nominal).

Wiring

Pre-wired with a 6 ft. pigtail for easy hookup to the low voltage supply cable.

Electrical

Input voltage range (VAC): 11 - 15 (magnetic low voltage transformer required).

IP67 rating

Completely dust-tight and sealed against direct jets of water.

Labels

ETL and cETL listed.

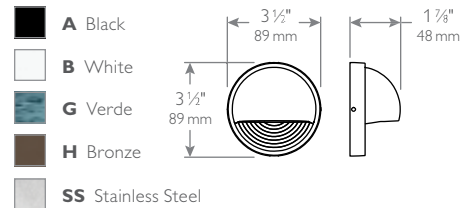

Series	Finish	Lamp	CCT
		LED2	W
DUL1 Composite Deck light	A Black G Verde H Bronze	LED2 LED	W Warm (3000K)
DCL1 Brass Deck light	N Natural Brass	LED2 LED	W Warm (3000K)

Fixture will be shipped with lamp. Lamp not sold separately.

Features

- 12 Volt
- T3 LED lamp
- 1.2 total Watts
- >80 CRI

Housing

A, G, H: Injection fiberglass reinforced molded ULTEM High Performance Polymer housing with stainless steel set screws.
N: Solid die-cast brass housing and backplate with stainless steel set screws.

Finish

A, G & H: Color impregnated composite material in; black, bronze or hand-rubbed verde antiqued over black.
N: Natural brass.

Optics

Frosted annealed glass.

LED

- 15,000 hours life at 25°C ambient temperature and 70% lumen maintenance.
- Color temp (CCT): warm white (3,000K nominal).

Wiring

Pre-wired with a 6 ft. pigtail for easy hookup to the low voltage supply cable.

Electrical

Input voltage range (VAC): 11 - 15 (magnetic low voltage transformer required).

IP67 rating

Completely dust-tight and sealed against direct jets of water.

Labels

ETL and cETL listed.

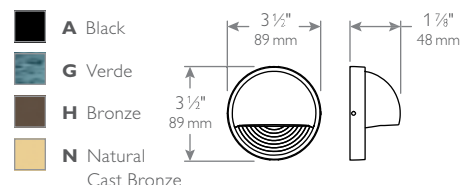

LED Path and walkway lighting

AL41

Aluminum Path light



AL41-GS7LED2W

A Black **G** Verde

Series	Finish	Mount	Lamp	CCT
AL41	<input type="checkbox"/>	S7	LED2	W
AL41 Aluminum Path light	A Black G Verde	S7 Stake	LED2 LED	W Warm (3000K)

Fixture will be shipped with lamp. Lamp not sold separately.

Features

- 12 Volt
- T3 LED lamp
- 1.2 total watts
- ½" NPS fitter
- Ships with S7 mounting stake

Housing

Cast aluminum with stainless steel fasteners.

Finish

Thermoset powder coated in; black or hand-rubbed verde antiqued over black.

Finial

Clear seeded glass finial sparkles when illuminated.

LED

- Delivers 70% lumen maintenance at 15,000 hours.
- Color temp (CCT): warm white (3,000K nominal).

Wiring

Pre-wired with a 3 ft. pigtail for easy hookup to the supply cable.

Electrical

Input voltage range (VAC): 10.8 - 13.2, regulated to 12V DC. Integral surge protector (magnetic low voltage transformer required).

IP66 rating

Dust tight and sealed against direct jets of water.

Labels

ETL and cETL listed.

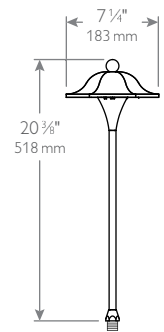

AL41 shown in photograph

LED Path and walkway lighting

CPL21

Aluminum Path light

Series	Finish	Mount	Lamp	CCT
CPL21		S7	LED2	W
CPL21 Aluminum Path light	A Black H Bronze	S7 Stake	LED2 LED	W Warm (3000K)

Fixture will be shipped with lamp. Lamp not sold separately.

Features

- 12 Volt
- T3 LED lamp
- 1.2 total watts
- ½" NPS fitter
- Ships with S7 mounting stake

Housing

Cast aluminum with stainless steel fasteners.

Finish

Thermoset powder coated in; black or bronze.

LED

- Delivers 70% lumen maintenance at 15,000 hours.
- Color temp (CCT): warm white (3,000K nominal).

Optics

Clear tempered flat glass lens.

Wiring

Pre-wired with a 3ft. pigtail for easy hookup to the supply cable.

Electrical

Input voltage range (VAC): 10.8 - 13.2, regulated to 12V DC. Integral surge protector (magnetic low voltage transformer required).

IP66 rating

Dust tight and sealed against direct jets of water.

Labels

ETL and cETL listed.

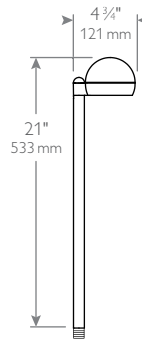

A Black **H** Bronze

CPL21-HS7LED2W

LED Low Voltage

Series	CCT	Mount
CUL2D		S7
CUL2D Copper Path light	W Warm C Cool	S7 Stake

Features

- 12 Volt
- 3.6 total watts
- ½" NPS fitter
- Stem (included)
- > 80 CRI
- Ships with S7 mounting stake

Housing

Spun solid copper roof and solid copper stem. Machined copper or brass threaded adapter for tool-less relamping.

Finish

Natural copper will patina with age. Reflective white powdercoat on underside of roof.

LED

- 50,000 hours life at 25°C ambient temperature and 70% lumen maintenance.
- Color temp (CCT): 92 lumen cool white (4,000K nominal) or 80 lumen warm white (3,000K nominal).

Optics

Frosted borosilicate glass.

Wiring

Pre-wired with a 6ft. pigtail for easy hookup to the supply cable.

Electrical

Input voltage range (VAC): 11 - 15 (magnetic low voltage transformer required).

IP67 rating

Dust tight and sealed against direct jets of water.

Labels

ETL and cETL listed.

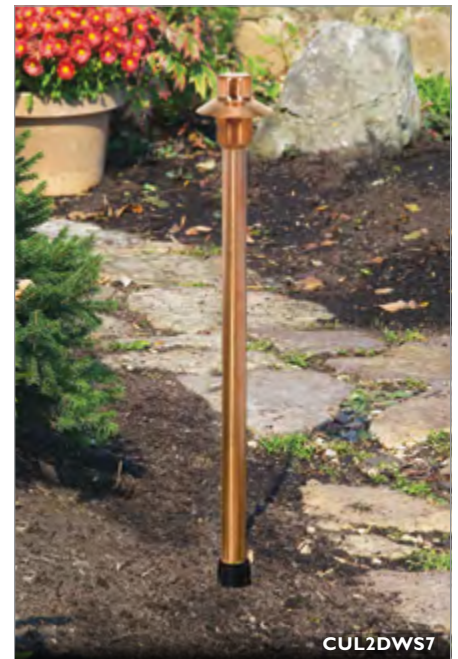
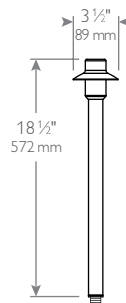

Copper

CUL2DWS7

LED Path and walkway lighting

CUL7D

Copper Path light



CUL7DWS7

Copper

Series	CCT	Mount
CUL7D	<input type="checkbox"/>	S7
CUL7D Copper Path light	W Warm C Cool	S7 Stake

Features

- 12 Volt
- 3.6 total watts
- ½" NPS fitter
- Stem (included)
- > 80 CRI
- Ships with S7 mounting stake

Housing

Spun solid copper roof and solid copper stem. Machined copper or brass threaded adapter for tool-less relamping.

Finish

Natural copper will patina with age. Reflective white powdercoat on underside of roof.

LED

- 50,000 hours life at 25°C ambient temperature and 70% lumen maintenance.
- Color temp (CCT): 92 lumen cool white (4,000K nominal) or 80 lumen warm white (3,000K nominal).

Optics

Frosted borosilicate glass.

Wiring

Pre-wired with a 6 ft. pigtail for easy hookup to the supply cable.

Electrical

Input voltage range (VAC): 11 - 15 (magnetic low voltage transformer required).

IP67 rating

Dust tight and sealed against direct jets of water.

Labels

ETL and cETL listed.

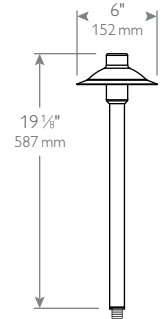

CUL9D

Copper Path light



CUL9DWS7

Copper

Series	CCT	Mount
CUL9D	W	S7
CUL9D Copper Path light	W Warm C Cool	S7 Stake

Features

- 12 Volt
- 3.6 total watts
- ½" NPS fitter
- Stem (included)
- > 80 CRI
- Ships with S7 mounting stake

Housing

Spun solid copper roof and solid copper stem. Machined copper or brass threaded adapter for tool-less relamping.

Finish

Natural copper will patina with age. Reflective white powdercoat on underside of roof.

LED

- 50,000 hours life at 25°C ambient temperature and 70% lumen maintenance.
- Color temp (CCT): 92 lumen cool white (4,000K nominal) or 80 lumen warm white (3,000K nominal).

Optics

Clear/frosted borosilicate glass.

Wiring

Pre-wired with a 6 ft. pigtail for easy hookup to the supply cable.

Electrical

Input voltage range (VAC): 11 - 15 (magnetic low voltage transformer required).

IP67 rating

Dust tight and sealed against direct jets of water.

Labels

ETL and cETL listed.

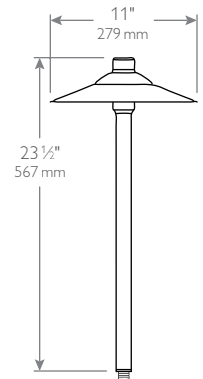

LED Path and walkway lighting

CUL10D

Copper Path light

Series	CCT	Mount
CUL10D	<input type="checkbox"/>	S7
CUL10D Copper Path light	W Warm C Cool	S7 Stake

Features

- 12 Volt
- 3.6 total watts
- ½" NPS fitter
- Stem (included)
- > 80 CRI
- Ships with S7 mounting stake

Housing

Spun solid copper roof and solid copper stem. Machined copper or brass threaded adapter for tool-less relamping.

Finish

Natural copper will patina with age. Reflective white powdercoat on underside of roof.

LED

- 50,000 hours life at 25°C ambient temperature and 70% lumen maintenance.
- Color temp (CCT): 92 lumen cool white (4,000K nominal) or 80 lumen warm white (3,000K nominal).

Optics

Clear/frosted borosilicate glass.

Wiring

Pre-wired with a 6 ft. pigtail for easy hookup to the supply cable.

Electrical

Input voltage range (VAC): 11 - 15 (magnetic low voltage transformer required).

IP67 rating

Dust tight and sealed against direct jets of water.

Labels

ETL and cETL listed.

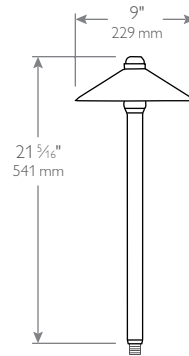

CUL10DWS7

 Copper

CUL14D

Copper Path light

Series	CCT	Mount
CUL14D	<input type="checkbox"/>	S7
CUL14D Copper Path light	W Warm C Cool	S7 Stake

Features

- 12 Volt
- 3.6 total watts
- ½" NPS fitter
- Stem (included)
- > 80 CRI
- Ships with S7 mounting stake

Housing

Spun solid copper roof and solid copper stem. Machined copper or brass threaded adapter for tool-less relamping.

Finish

Natural copper will patina with age. Reflective white powdercoat on underside of roof.

LED

- 50,000 hours life at 25°C ambient temperature and 70% lumen maintenance.
- Color temp (CCT): 92 lumen cool white (4,000K nominal) or 80 lumen warm white (3,000K nominal).

Optics

Frosted borosilicate glass.

Wiring

Pre-wired with a 6 ft. pigtail for easy hookup to the supply cable.

Electrical

Input voltage range (VAC): 11 - 15 (magnetic low voltage transformer required).

IP67 rating

Dust tight and sealed against direct jets of water.

Labels

ETL and cETL listed.

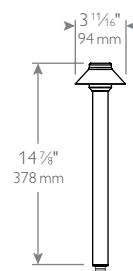

CUL14DWS7

 Copper

LED Path and walkway lighting

MUL4

Aluminum Path light



MUL4-GS7LED2W

A Black
 G Verde
 H Bronze

Series	Finish	Mount	Lamp	CCT
MUL4	<input type="checkbox"/>	S7	LED2	W
MUL4 Aluminum Path light	A Black G Verde H Bronze	S7 Stake	LED2 LED	W Warm (3000K)

Fixture will be shipped with lamp. Lamp not sold separately.

Features

- 12 Volt
- T3 LED lamp
- 1.2 total watts
- ½" NPS fitter
- Ships with S7 mounting stake

Housing

Cast aluminum with stainless steel fasteners.

Finish

Thermoset powder coated in; black, bronze or hand-rubbed verde antiqued over black.

LED

- Delivers 70% lumen maintenance at 15,000 hours.
- Color temp (CCT): warm white (3,000K nominal).

Wiring

Pre-wired with a 3 ft. pigtail for easy hookup to the supply cable.

Electrical

Input voltage range (VAC): 10.8 - 13.2, regulated to 12V DC. Integral surge protector (magnetic low voltage transformer required).

IP66 rating

Dust tight and sealed against direct jets of water.

Labels

ETL and cETL listed.

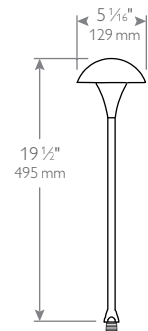

RL4

Aluminum Path light



RL4-AS7LED2W

A Black
 H Bronze

Series	Finish	Mount	Lamp	CCT
RL4	<input type="checkbox"/>	S7	LED2	W
RL4 Aluminum Path light	A Black H Bronze	S7 Stake	LED2 LED	W Warm (3000K)

Fixture will be shipped with lamp. Lamp not sold separately.

Features

- 12 Volt
- T3 LED lamp
- 1.2 total watts
- ½" NPS fitter
- Ships with S7 mounting stake

Housing

Cast aluminum construction.

Finish

Thermoset powder coated in; black or bronze.

LED

- Delivers 70% lumen maintenance at 10,000 hours.
- Color temp (CCT): warm white (3,000K nominal).

Optics

Frosted tempered glass.

Wiring

Pre-wired with a 3 ft. pigtail for easy hookup to the supply cable.

Electrical

Input voltage range (VAC): 10.8 - 13.2, regulated to 12V DC. Integral surge protector (magnetic low voltage transformer required).

IP66 rating

Dust tight and sealed against direct jets of water.

Labels

ETL and cETL listed.

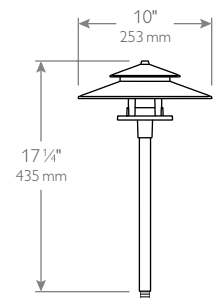

LED Path and walkway lighting

RL9

Aluminum Path light

Series	Finish	Mount	Lamp	CCT
RL9	<input type="checkbox"/>	S7	LED2	W
RL9 Aluminum Path light	A Black H Bronze	S7 Stake	LED2 LED	W Warm (3000K)

Fixture will be shipped with lamp. Lamp not sold separately.

Features

- 12 Volt
- T3 LED lamp
- 1.2 total watts
- 1/2" NPS fitter
- >80 CRI
- Ships with S7 mounting stake

Housing

Cast aluminum with stainless steel fasteners.

Finish

Thermoset powder coated in; black or bronze.

LED

- 15,000 hours life at 25°C ambient temperature and 70% lumen maintenance.
- Color temp (CCT): warm white (3,000K nominal).

Wiring

Pre-wired with a 3 ft. pigtail for easy hookup to the supply cable.

Electrical

Input voltage range (VAC): 11 - 15 (magnetic low voltage transformer required).

IP67 rating

Dust tight and sealed against direct jets of water.

Labels

ETL and cETL listed.

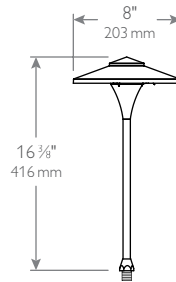

RL9-HS7LED2W

- A** Black
- H** Bronze

TRL4

Aluminum Path light

Series	Finish	Mount	Lamp	CCT
TRL4	G	S7	LED2	W
TRL4 Aluminum Path light	G Verde	S7 Stake	LED2 LED	W Warm (3000K)

Fixture will be shipped with lamp. Lamp not sold separately.

Features

- 12 Volt
- T3 LED lamp
- 3.8 total watts
- 1/2" NPS fitter
- Ships with S7 mounting stake

Housing

Cast aluminum with stainless steel fasteners.

Finish

Thermoset powder coated in; hand-rubbed verde antiqued over black.

LED

- Delivers 70% lumen maintenance at 15,000 hours.
- Color temp (CCT): warm white (3,000K nominal).

Optics

Frosted borosilicate glass.

Wiring

Pre-wired with a 3 ft. pigtail for easy hookup to the supply cable.

Electrical

Input voltage range (VAC): 10.8 - 13.2, regulated to 12V DC. Integral surge protector (magnetic low voltage transformer required).

IP66 rating

Dust tight and sealed against direct jets of water.

Labels

ETL and cETL listed.

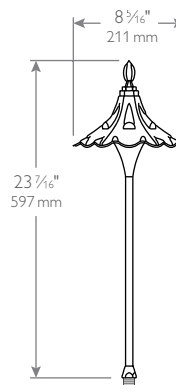

TRL4-GS7LED2W

- G** Verde

LED Underwater lighting

UWL1075

Cast Bronze Underwater



UWL1075-NLED7NFW

H Bronze

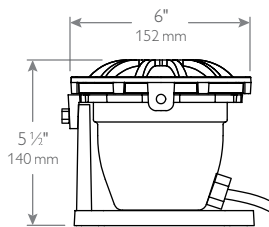

Series	Finish	Lamp	Optics	CCT
UWL516	H			
UWL516 Composite Underwater	H Bronze	LED7 LED	NF Narrow Flood FL Flood	W Warm (3000K)

Fixture will be shipped with lamp. Lamp not sold separately.

Features

- 12 Volt
- 50 watt max
- MR16 LED lamp

Housing

Cast nickel bronze guard, spun stainless steel housing, stainless steel fasteners.

Base

Cast nickel bronze swivel base.

LED

- 7W lamp with 24° or 36° beam spread.
- Delivers 70% lumen maintenance at 25,000 hours.
- Color temp (CCT): warm white (3,000K nominal).
- Lamp only sold integral to UWL1075 fixture.

Finish

Natural finish.

Optics

Tempered clear convex glass (see accessories for optional colored lenses).

Wiring

Pre-wired with a 10ft. SVO cord for hard wiring to the low voltage supply cable.

Socket

Bi-pin (GY6.5).

Labels

ETL and cETL listed.

Note: Underwater fixtures are not for use in swimming pools or spas due to exposed wiring. Hand tighten screws, avoid over tightening. Consult factory for pool and spa rated transformers.

UWUL516

Composite Underwater



UWUL516-HLED7NFW

H Bronze

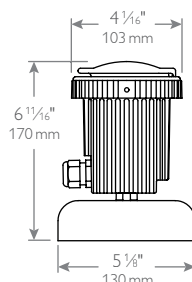

Series	Finish	Lamp	Optics	CCT
UWUL516	H	LED7		W
UWUL516 Composite Underwater	H Bronze	LED7 7W LED	NF Narrow Flood FL Flood	W Warm (3000K)

Fixture will be shipped with lamp. Lamp not sold separately.

Features

- 12 Volt
- 50 watt max
- MR16 LED lamp

Housing

Injection molded fiberglass reinforced ULTEM® high performance polymer.

Base

Weighted concrete with swivel to allow up to 90° aiming.

Ring

Single-piece injection molded ULTEM® high performance polymer with gasketed lens. Twist-off operation for ease of maintenance.

Finish

Color impregnated bronze composite.

LED

- 7W lamp with 24° or 36° beam spread.
- Delivers 70% lumen maintenance at 25,000 hours.
- Color temp (CCT): warm white (3,000K nominal).
- Lamp only sold integral to UWUL516 fixture.

Optics

Tempered clear glass with high impact polycarbonate clear lens guard.

Wiring

Pre-wired with a 10ft. STWA cord for hard wiring to the low voltage supply cable.

Socket

Bi-pin (GU5.3).

Labels

ETL and cETL listed.

Note: Underwater fixtures are not for use in swimming pools or spas due to exposed wiring. Hand tighten screws, avoid over tightening. Consult factory for pool and spa rated transformers.

LED Transformers & Accessories

12 & 15 Volt Transformers



TC152-12
Standard Transformer



TC___-15
Stainless Steel Transformers



TSS___-15
Stainless Steel Transformers

Catalog Number	Description	Height	Width	Depth	PC3	PC15	T5	T6
TC152-12 TC152-12TP	Standard Transformers 150VA, 12V TAP, painted	11 1/2"	3 3/4"	3 1/4"	-	-	-	-
	150VA, 12V TAP, painted, w/timer, PC	11 1/2"	3 3/4"	3 1/4"	-	-	-	-
TC354-15 TC654-15 TC954-15	Stainless Steel Transformers 300VA, 15V Multitap, painted, hinged door	11 3/8"	6 3/8"	5 5/8"	◆	◆	◆	◆
	600VA, 15V Multitap, painted, hinged door	12 5/8"	7 1/2"	6"	◆	◆	◆	◆
	900VA, 15V Multitap, painted, hinged door	14"	8 7/8"	7"	◆	◆	◆	◆
TSS354-15 TSS654-15 TSS954-15	Stainless Steel Transformers 300VA, 15V Multitap, stainless, hinged door	11 3/8"	6 3/8"	5 5/8"	◆	◆	◆	◆
	600VA, 15V Multitap, stainless, hinged door	12 5/8"	7 1/2"	6"	◆	◆	◆	◆
	900VA, 15V Multitap, stainless, hinged door	14"	8 7/8"	7"	◆	◆	◆	◆

Accessory compatibility is model specific. Please see accessory descriptions below.

12 & 15 Volt Transformers Accessories



T5
Plug-in analog transformer time clock.



T6
Plug-in digital transformer time clock with battery back-up.



PC3
Plug-in photo cell, 3" (78mm) lead for direct mount to transformer housing.



PC15
Plug-in photo cell, 15ft. (46.8m) lead for remote mount.

Mounting Stakes Accessories



S3 Impact-resistant PVC stake
Mounting stake suitable for wet locations and constructed of heavy wall, impact-resistant PVC with threaded 1/2" (13mm) NPT hub and ground wire.



S7 Two-piece low voltage stake
Mounting stake is constructed of non-corrosive PVC with integral 1/2" (13mm) NPS fitter. Includes ABS, removable 1/2" (13mm) NPS fitter.
1 3/8" (35mm) O.D. x 9 1/2" (241mm) long

LED Line Voltage

What is an LED?

Simply put, an LED, or Light Emitting Diode, is a diode that is chip-mounted in a reflector cup and held in place by a milled steel frame connected to a pair of electrical wires. When current flows across the junction of the two different materials, light is produced from within the solid crystal chip. Philips Hadco uses bright white LEDs as standard, which are developed by coating a blue LED with a phosphor, and thereby generating a white color.

Why use LED?

- LEDs provide a longevity that is up to 20 times that of standard incandescent lamps, translating to low maintenance.
- LEDs are solid-state devices, meaning no moving parts, glass or filaments to break.
- LEDs are small in size and resistant to vibration or shock.
- LEDs contain no mercury and are environmentally friendly.
- LEDs are more efficient, using up to 90% less energy than other light sources based on watts.



LED Line Voltage

Accent lighting	38
B1, B4, BT1, BT5016, BU3, MA3, B3	
Flood lighting	42
WAM1D/WBM1D	
Step and Aisle lighting	43
96 Line, RSF2, RSS2, RSC2, RSV2	
In-ground lighting	46
i1.5, i2.5, i3.5, iT216, i3, SL-23, SL-25, SL-33, SL-34, SL-43	
Bollard lighting	58
RD6/RF6, DB14/DB21/DB30	
Residential lighting	60
Palermo, Riviera, Manor	

LED Accent lighting

B1

Aluminum Bullet



B1ALED7NFWS

- A Black
- G Verde
- H Bronze

Series	Finish	Lamp	Optics	CCT	Shroud
B1	<input type="checkbox"/>	LED7	NF	W	<input type="checkbox"/>
B1 Aluminum Bullet	A Black G Verde H Bronze	LED7 8W	NF Narrow Flood	W Warm	S Short L Long

Fixture will be shipped with lamp. Lamp not sold separately.

Features

- 120 Volt
- PAR20 LED Lamp
- 1/2" NPS fitter
- Shroud required

Housing

Die-cast aluminum with fully-adjustable swivel arm with vibration-proof locking teeth.

Shroud

Die-cast aluminum, provided with lens and silicone O-ring. Either long or short shroud is required.

LED

- 25,000 hours life (no mercury).
- 8W lamp with 25° beam spread.
- Color temp (CCT): cool white (4,000K nominal) or warm white (2,700K nominal). Lamp only sold integral to B1.

Finish

Thermoset powder coated in; black, bronze or hand-rubbed verde antiqued over black.

Optics

Provided with optional shrouds only.

Wiring

Pre-wired with high temperature #18 wire.

Socket

High temp porcelain medium base.

Labels

ETL and cETL listed.

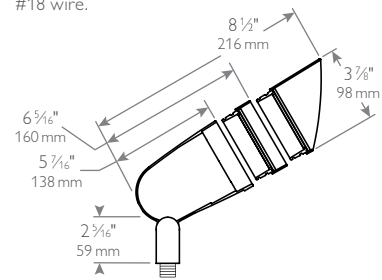

B4

Aluminum Bullet



B4ALED18NFWS

- A Black
- G Verde
- H Bronze

Series	Finish	Lamp	Optics	CCT	Shroud
B4	<input type="checkbox"/>	LED18	NF	W	<input type="checkbox"/>
B4 Aluminum Bullet	A Black G Verde H Bronze	LED18 19W	NF Narrow Flood	W Warm	S Short L Long

Fixture will be shipped with lamp. Lamp not sold separately.

Features

- 120 Volt
- PAR38 LED Lamp
- 1/2" NPS fitter

Housing

Die-cast aluminum with fully-adjustable swivel arm and vibration-proof locking teeth.

Shroud

Die-cast aluminum, provided with lens and silicone O-ring. Either long or short shroud is required.

LED

- 25,000 hours life (no mercury).
- 19W lamp with 25° beam spread. Color temp (CCT): warm white (3,000K nominal). Lamp only sold integral to B4.

Finish

Thermoset powder coated in; black, bronze or hand-rubbed verde antiqued over black.

Optics

Clear flat tempered glass included with shroud.

Labels

ETL and cETL listed.

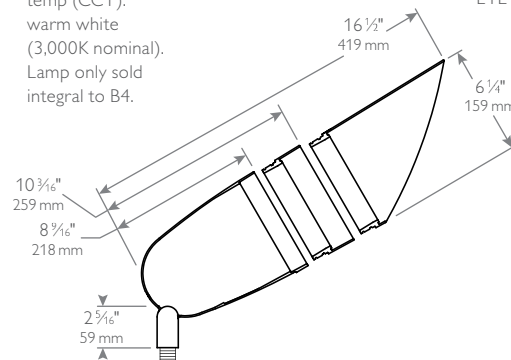

LED Accent lighting

BT1 Aluminum Bullet

Series	Finish	Lamp	Optics	CCT	Shroud
BT1	<input type="checkbox"/>	<input type="checkbox"/>	<input type="checkbox"/>	<input type="checkbox"/>	<input type="checkbox"/>
BT1 Aluminum Bullet	A Black H Bronze	LED7 7W	FL Flood NF Narrow Flood	W Warm	S Short L Long

Fixture will be shipped with lamp. Lamp not sold separately.



BT1ALED7FLCL

Features

- 120 Volt
- MR16 LED Lamp
- ½" NPS fitter
- Integral stepdown transformer

Housing

Die-cast aluminum with fully-adjustable swivel arm and vibration-proof locking teeth.

Shroud

Fully-rotatable, gasketed, cast aluminum.

LED

- 25,000 hours life (no mercury).
- 7W lamp with 25° or 35° beam spread.
- Color temp (CCT): warm white (3,000K nominal). Lamp only sold integral to BT1.

Finish

Thermoset powder coated in; black or bronze.

Optics

Clear, tempered glass.

Wiring

Pre-wired with #18AWG black, white and ground wire.

Electrical

Stepdown transformer reduces line voltage to 12V. Transformer is potted/encapsulated and features thermal overload protection. Can be used with energy-efficient halogen lamp

Socket

Ceramic bi-pin (GU5.3).

Labels

ETL and cETL listed.

- A** Black
- H** Bronze

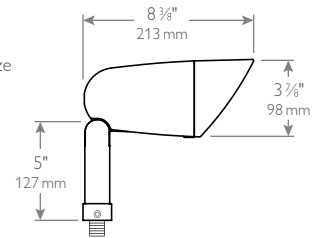

B4 shown in photograph

LED Accent lighting

BT5016

Aluminum Bullet



BT5016HLED4NFW

- A Black
- H Bronze

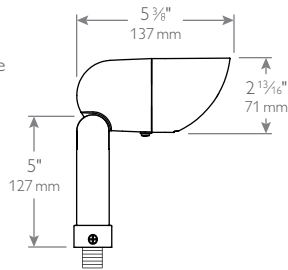

Series	Finish	Lamp	Optics	CCT
BT5016	<input type="checkbox"/>	<input type="checkbox"/>	<input type="checkbox"/>	<input type="checkbox"/>
BT5016 Aluminum Bullet	A Black H Bronze	LED7 7W	FL Flood NF Narrow Flood	W Warm

Fixture will be shipped with lamp. Lamp not sold separately.

Features

- 120 Volt
- MR16 LED Lamp
- 1/2" NPS fitter
- Integral stepdown transformer

Housing

Die-cast marine-grade aluminum with fully-adjustable swivel arm and vibration-proof locking teeth.

Shroud

Fully-rotatable, gasketed, cast marine-grade aluminum.

LED

- 25,000 hours life (no mercury).
- 7W lamp with 25° or 35° beam spread.
- Color temp (CCT): warm white (3,000K nominal). Lamp only sold integral to BT5016.

Finish

Thermoset powder coated in; black or bronze.

Optics

Clear tempered glass affixed at 10° angle for natural cleaning.

Wiring

Pre-wired with #18 AWG black, white and ground wire.

Electrical

Stepdown transformer reduces line voltage to 12V. Transformer is potted/encapsulated and features thermal overload protection. Can be used with energy-efficient halogen lamp.

Socket

Ceramic bi-pin (GU5.3).

Labels

ETL and cETL listed.

BU3

Composite Bullet



BU3GLED13NFW

- A Black
- G Verde
- H Bronze

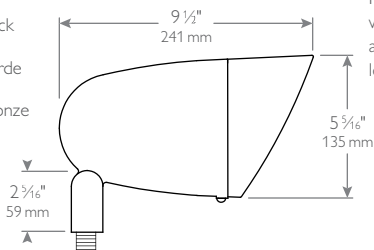

Series	Finish	Lamp	Optics	CCT
BU3	<input type="checkbox"/>	LED13	NF	<input type="checkbox"/>
BU3 Aluminum Bullet	A Black G Verde H Bronze	LED13 13W	NF Narrow Flood	W Warm C Cool

Fixture will be shipped with lamp. Lamp not sold separately.

Features

- 120 Volt
- PAR30 LED Lamp
- 1/2" NPS fitter
- Long shroud included

Housing

One-piece injection molded Ultem High Performance Polymer with fully-adjustable swivel arm and vibration-proof locking teeth.

LED

- 25,000 hours life (no mercury).
- 13W lamp with 25° beam spread. Color temp (CCT): cool white (4,000K nominal) or warm white (2,700K nominal). Lamp only sold integral to BU3.

Finish

Color impregnated material in black, bronze, or hand-rubbed verde antiqued over black.

Wiring

Pre-wired with high temperature #18 wire.

Socket

High temperature porcelain medium base..

Labels

ETL and cETL listed.

LED Accent lighting

MA3 Aluminum Bullet

Series	Optics	Source	CCT	Finish	Shroud
MA3	<input type="checkbox"/>	<input type="checkbox"/>	<input type="checkbox"/>	<input type="checkbox"/>	<input type="checkbox"/>
MA3 Aluminum Bullet	SP Spot FL Flood	D LED	W Warm C Cool	A Black H Bronze	L Long 45° (optional)

Features

- 120 Volt
- 6.4 total watts
- ½" NPS fitter

Housing

Precision machined aluminum from 6061-T6 material. Stainless Steel fasteners.

LED

- 35,000 hours life (at 30°C ambient temperature and 70% lumen maintenance).
- Color temp (CCT): 3,000K or 4,000K

Finish

Thermoset powder coated in; black or bronze.

Optics

Two beam spreads (spot - 20°, flood - 40°).

Wiring

Pre-wired with high temperature #18 wire. Input voltage range (VAC) 120-277.

IP65 rating

Completely dust-tight and sealed to withstand low pressure jets of water from any direction.

Labels

ETL and cETL listed.

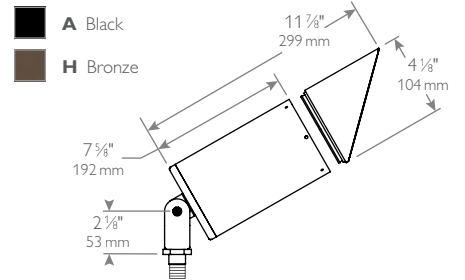

B3 Aluminum Bullet

Series	Finish	Lamp	Optics	CCT
B3	<input type="checkbox"/>	LED13	NF	<input type="checkbox"/>
B3 Aluminum Bullet	A Black G Verde H Bronze	LED13 13W	NF Narrow Flood	W Warm C Cool

Fixture will be shipped with lamp. Lamp not sold separately.

Features

- 12 Volt
- PAR30 LED Lamp
- ½" NPS fitter

Housing

One-piece injection molded Ultem High Performance Polymer with fully-adjustable swivel arm and vibration-proof locking teeth.

Shroud

Long shroud included.

LED

- 25,000 hours life (no mercury).
- 13W lamp with 25° beam spread. Color temp (CCT): warm white (2,700K nominal). Lamp only sold integral to B3.

Finish

Color impregnated material in black or bronze, hand-rubbed verde antiqued over black.

Wiring

Pre-wired with high temperature #18 wire.

Socket

High temperature porcelain medium base.

Labels

ETL and cETL listed.

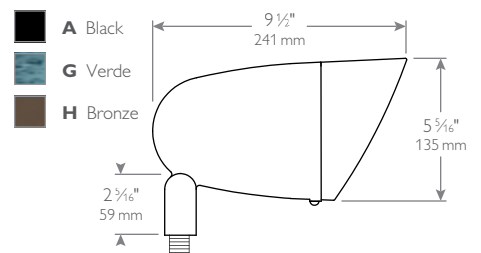

LED Flood lighting

WAM1D/WBM1D

Aluminum Flood light



- A** Black
- B** White
- G** Verde
- H** Bronze

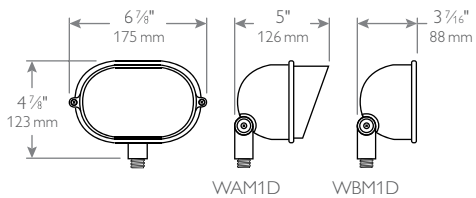

Series	CCT	Lens	Finish
<input type="text"/>	<input type="text"/>	<input type="text"/>	<input type="text"/>
WAM1D Aluminum Flood light with shroud WBM1D Aluminum Flood light without shroud	W Warm C Cool	F Frosted Lens - Clear Lens	A Black B White G Verde H Bronze

Features

- 120 Volt
- 9.1 total watts at 120 VAC
- 13 total watts at 277 VAC
- 1/2" NPS fitter
- 481 lumens
- >80 CRI

Housing

Die-cast aluminum with fully-adjustable swivel arm with vibration-proof locking teeth.

Shroud

Gasketed, cast aluminum available (WAM1D).

Finish

Thermoset powder coated in; black, white, bronze or hand-rubbed verde antiqued over black.

LED

- 50,000 hours life at 25°C ambient temperature and 70% lumen maintenance.
- Color temp (CCT): cool white (4,000K) or warm white (3,000K).

Optics

Clear or frosted tempered glass. 150° LED spread (equivalent to wide flood).

Wiring

Pre-wired with #18 AWG black, white and ground wire.

Electrical

Smart Select Electronic Driver 120 to 277 VAC input; 50-60Hz; auto-sensing.

IP66 rating

Completely dust-tight and sealed against direct jets of water.

Labels





ETL and cETL listed.



WAM1D shown in photograph

LED Step and Aisle lighting

96 Line Aluminum Step light

Faceplates	Mounting	Wattage	Voltage	Finish
				
Composite 960C Round in white 961C Round in black 962C Square in white 963C Square in black	S Wall or Ceiling Surface Mount	4 4W LED 3000K (85 CRI)	UNIV 120V-277V (50 or 60 Hz)	BLP Black* BRP Bronze Paint WP White Paint NP Black OC Optional Color Paint Specify RAL designation SC Special Color Paint Must supply color chip.
Aluminum 960A Round 962A Square				

The 96 Line is UL and CUL listed for Wet Locations.
 * Standard color of composite material.



Four incredible watts of illumination

A remarkable advancement in architectural lighting built around the latest in LED technology – the 96 Line. With an integrated optical system that relies on a single four-watt LED, this minimally scaled luminaire achieves a remarkable level of illumination. In pedestrian thoroughfares, and along stairways, 96 Line is an exciting design option.

The die cast aluminum base and LED optical system are an integrated package. To replace the LED, simply remove the faceplate, and install a new module. Plug and play. Fast, simple, easy does it.

An integrated LED, driver and optic allows the 96 Line to achieve maximum performance from minimal power.

Integral leveling bubble simplifies installation, assuring perfect alignment of each 96 Line steplight.

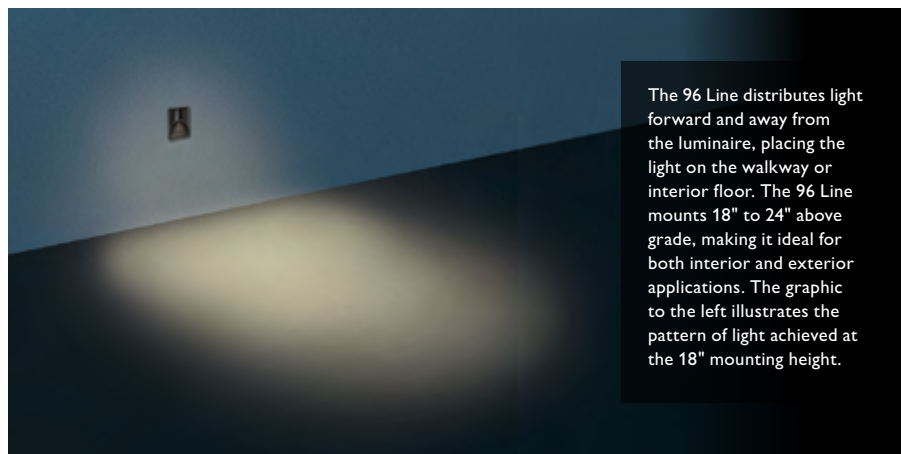
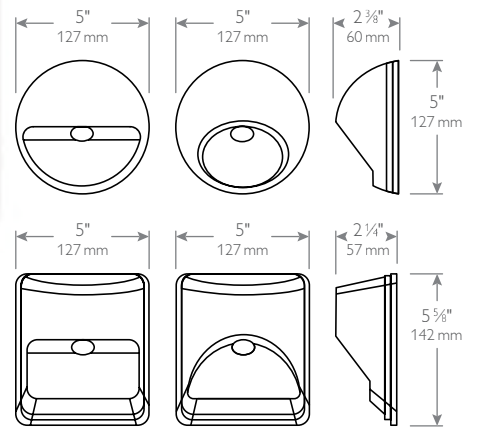

Subtle downlight wall washing with wide and uniform distribution are noteworthy characteristics of the 96 Line.

Mounting

Mounting over a 3.5" or 4" recessed octagonal box

Mounting over a 4" Recessed Square Box

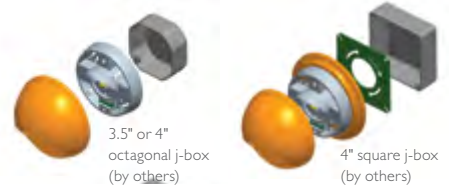

Two choices of faceplates

A composite injection-molded version with an integral black finish, or die cast aluminum in the 960 and 962 styles. All faceplates are lightly textured and are provided with a UV-resistant, semi-gloss finish in standard, optional or special colors. Featuring soft corners, uniform distribution, concealed mounting hardware and consistent visual styling cues, the 96 Line is a smart and practical choice for step and aisle lighting.



LED Step lighting

RSF2

Polycarbonate Step light

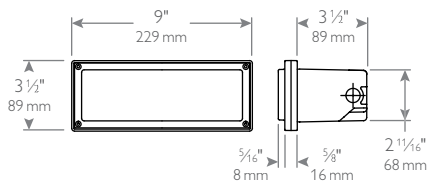
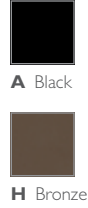

RSS2

Polycarbonate Step light

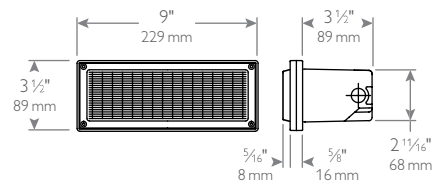
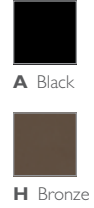

RSC2

Aluminum or Cast Bronze Step light

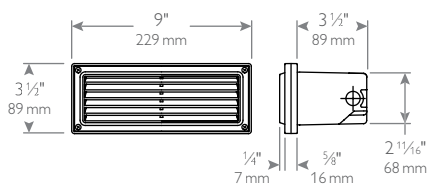
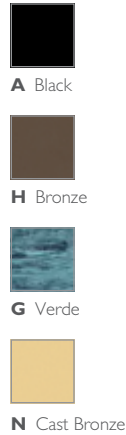

RSV2

Aluminum or Cast Bronze Step light

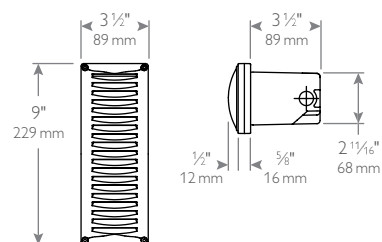
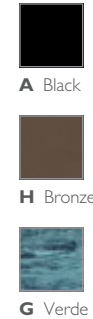

LED Step lighting

RS Step lights

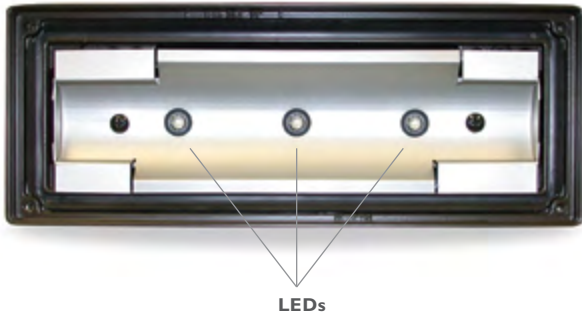

Photometry

Three 1W LEDs
2 foot mounting height

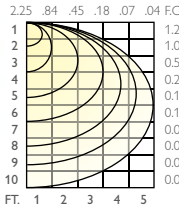

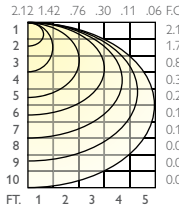

Photometry

Five 1W LEDs
2 foot mounting height

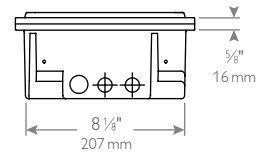

Bottom view of all



Series	Finish	Optics	Lamp	Lens	Voltage
<input type="checkbox"/>	<input type="checkbox"/>	<input type="checkbox"/>	<input type="checkbox"/>	<input type="checkbox"/>	<input type="checkbox"/> E
RSF2 Polycarbonate Step light	A Black H Bronze	L5 Opal lens	D3 (3) 1W LEDs D5 (5) 1W LEDs	W Warm amber	E 120V
RSS2 Polycarbonate Step light	A Black H Bronze	K5	D3 (3) 1W LEDs D5 (5) 1W LEDs	- None	E 120V
RSC2 Aluminum or Cast Bronze Step light RSV2 Aluminum or Cast Bronze Step light	A Black G Verde H Bronze	K5 Aluminum or Cast Bronze louvers	D3 (3) 1W LEDs D5 (5) 1W LEDs	W Warm amber	E 120V
Series	Finish	Option			
<input type="checkbox"/> RS2	<input type="checkbox"/>	<input type="checkbox"/>			
RS2	A Black G Verde H Bronze N Cast Bronze	HO Housing only (pre-shipment)			

* Use when Housing Only (**HO**) is ordered for pre-shipment to complete catalog number of fixture without housing.

Housing

Die-cast aluminum back box contains less than 0.3% copper to prevent corrosion in concrete or masonry applications.

Trim ring

- Die-cast aluminum trim contains less than 0.3% copper to resist corrosion.
- Cast bronze fixture has polycarbonate, color-impregnated, dark bronze finish (RSC2 & RSV2).

Reflector

Specular aluminum formed reflector.

Faceplates

Cast louver

- Die-cast copper-free aluminum with 45° cutoff, with frosted tempered glass.
- Cast bronze louver is natural cast bronze with frosted tempered glass (RSC2 and RSV2 only).
- Amber Lens option (3000k)

Opal lens

- Opal UV stabilized injection molded polycarbonate with frosted glass siliconed on inside for durability.

Louvers

- Clear UV stabilized injection molded polycarbonate with 45° louvered screen insert.

Finish

Polycarbonate

Color impregnated composite material in; black or bronze (RSF2 / RSS2).

- Aluminum parts have zinc-rich primer and for durability a thermoset powder coat in; black, bronze or hand-rubbed verde antiqued over black (RSC2 / RSV2).

Natural cast bronze finish (RSC2).

LED

- Delivers 70% lumen maintenance at 50,000 hours.
- Cool white (6,300K nominal).
- Amber lens option (3,000K).
- (3) 1W LEDs: 4W total.
- (5) 1W LEDs: 5W total.

ADA compliant

Compliant when used in indoor and outdoor wall applications.

Wiring

Supply wires connect directly to the quick connect on the integral power supply.

Accessories

All units supplied with mounting hardware for concrete pour installation. If other mounting kits are required, order accessory.

Construction mounting kits



- MAKM** Masonry kit
- MAKNS** New Stud Wall kit
- MAKES** Existing Stud Wall kit

IP66 rating

Dust tight and sealed against direct jets of water.

Labels

ETL and cETL listed.

LED In-ground lighting

LED Line Voltage



11.5 shown in photograph

LED In-ground lighting

i1.5

Composite Inground with Trim Ring

Integrated Lamp

Series	Finish	Lamping	Optics	CCT	Voltage
i1.5		LED			
i1.5 Composite Inground	N Cast Bronze SS Stainless Steel	LED10 10W MR16 Bi-Pin	SP Spot	W Warm	120 120V
			FL Flood	W Warm C Cool	277 277V
		LED13 13W PAR30 Short	SP Spot	W Warm	120 120V
			FL Flood	W Warm C Cool	

Fixtures with PAR30 LED lamp will be shipped with fixture loose, not installed.
Fixtures with MR16 lamp will be shipped with lamp installed. Lamps not sold separately.

Integrated Module

Series	Finish	Output	CCT
i1.5			
i1.5 Inground Trim Ring	N Cast Bronze SS Stainless Steel	SP Spot	W Warm
		NF Narrow Flood	C Cool
		FL Flood	

Must order LEDADP, Adaptor Ring if ordering an internal accessory.

Features

- 120 Volt
- MR16 LED Lamp
- PAR30S LED Lamp
- LED module

Housing

Single-piece compression molded, fiberglass reinforced polyester composite housing. Separate sealed compartments. Potted factory seal with anti-wicking wiring. Hinged lens ring with captive lens and fasteners. Only two fasteners required to secure lens ring. UL Listed silicone-filled wire nuts provided—no encapsulant required.

Trim ring

Natural cast bronze or cast stainless steel. Secured with stainless steel screws (supplied standard).

Rock guard



Natural cast bronze or cast stainless steel. Secured with stainless steel screws (sold separately).

Half dome



Field adjustable for directional glare control. Natural cast bronze or cast stainless steel. Secured with stainless steel screws (sold separately).

Lens

Clear convex, tempered borosilicate for high-impact resistance. 3,000lb live-load rated, drive-over.

LED lamp

- 25,000 hours life (no mercury).
- 10W with 15° or 36° beam spread.
- 13W with 22° or 25° beam spread (only sold integral to i1.5 fixture).
- Color temp. (CCT): cool white (4,000K nominal) or warm white (2,700K nominal).

LED module

3,000K or 4,000K CCT. 17 Total Watts consumed. Approx. 50,000 hours of operation life at 25°C ambient temperature and 70% lumen maintenance.

Socket

EnduraLED: MR16 Bi-pin. EnduraLED: Medium Base.

Optics

Available with spot, narrow flood or flood beam pattern. EnduraLED lamps: spot or flood beam pattern.

Gasket

Single-piece wrap around molded 100% silicone for lens assembly. Gasket for junction box cover is single-piece die-cut neoprene.

Aiming

15° either side of vertical and full 360° rotation. Angle degree marks for precise vertical aiming with tool-less aiming.

ADA compliant

Compliant when used in concrete and flush-mounted with CPS15.

Electrical

LED module is a key-slotted ballast assembly with quick disconnects mounted to cast aluminum bracket for easy maintenance. e-Vision electronic ballasts automatically detect 120-277 volts, 50/60 Hz, HPF. Ballasts provide ± 5% lamp power regulation with ± 10% input voltage regulation. Incandescent (MR16) - utilizes stepdown transformer.

IP66/68 rating

Dust-tight and dual rated – sealed against direct jets of water and against continuous immersion up to a depth of 1 meter (3.28 feet).

Labels

ETL and cETL listed.



- N Cast Bronze
- SS Stainless Steel

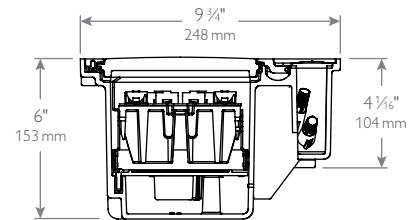

LED In-ground lighting

i2.5

Composite Inground with Trim Ring



i2.5NLED12SPW

- N** Cast Bronze
- SS** Stainless Steel

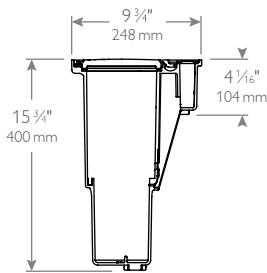

Series	Finish	Lamping	Optics	CCT
i2.5	<input type="checkbox"/>	<input type="checkbox"/>	<input type="checkbox"/>	<input type="checkbox"/>
i2.5 Composite Inground	N Cast Bronze SS Stainless Steel	-	SP Spot	W Warm*
			NF Narrow Flood	C Cool*
			FL Flood	
		LED12 12W	SP Spot	W Warm
			NF Narrow Flood	C Cool
		LED13 13W PAR30 Long	NF Narrow Flood	W Warm

* Must order LEDADP, Adaptor Ring if ordering an internal accessory.
Fixtures with PAR30 LED lamp will be shipped with fixture loose, not installed.
Lamps not sold separately.

Features

- 120 Volt
- PAR30L LED
- 17 total watts

Housing

Single-piece compression molded, fiberglass reinforced polyester composite housing. Separate sealed compartments. Potted factory seal with anti-wicking wiring. Hinged lens ring with captive lens and fasteners. Only two fasteners required to secure lens ring. UL Listed silicone-filled wire nuts provided—no encapsulant required.

Trim ring

Natural cast bronze or cast stainless steel. Secured with stainless steel screws (supplied standard).

Rock guard

Natural cast bronze or cast stainless steel. Secured with stainless steel screws (sold separately).

Half dome

Field adjustable for directional glare control. Natural cast bronze or cast stainless steel. Secured with stainless steel screws (sold separately).

Lens

Clear convex, tempered borosilicate for high-impact resistance. 3,000lb live-load rated, drive-over.

LED lamp

- 25,000 hours life (no mercury).
- 12W with 22° or 25° beam spread. Color temp. (CCT): cool white (4,000K nominal) or warm white (2,700K nominal)
- 13W with 25° beam spread (only sold integral to i2.5 fixture). Color temp. (CCT): warm white (2,700K nominal).

Socket

Incandescent PAR30 Long EnduraLED: Medium Base.

Optics

Available with spot, narrow flood or flood beam pattern. EnduraLED lamps: spot or flood beam pattern.

Gasket

Single-piece wrap around molded 100% silicone for lens assembly. Gasket for J-box cover is single-piece die-cut neoprene.

LED module

4,000K CCT or 3,000K CCT. Approx. 50,000 hours of operational life (at 25°C ambient temperature and 70% lumen maintenance). >80CRI.

Aiming

15° either side of vertical and full 360° rotation. Angle degree marks for precise vertical aiming with tool-less aiming.

ADA compliant

Compliant when used in concrete and flush-mounted with CPS15.

Electrical

LED module is a key-slotted ballast assembly with quick disconnects mounted to cast aluminum bracket for easy maintenance. e-Vision electronic ballasts automatically detect 120-277 volts, 50/60 Hz, HPF. Ballasts provide ± 5% lamp power regulation with ± 10% input voltage regulation. Incandescent (MR16) - utilizes stepdown transformer.

IP66/68 rating

Dust-tight and dual rated – sealed against direct jets of water and against continuous immersion up to a depth of 1 meter (3.28 feet).

Labels

ETL and cETL listed.

LED In-ground lighting

i3.5

Composite Inground with Trim Ring

Series	Finish	Lamping	Optics	CCT
i3.5	N			
i3.5 Composite Inground	N Cast Bronze	–	SP Spot NF Narrow Flood FL Flood	W Warm C Cool
		LED18 19W	SP Spot NF Narrow Flood	W Warm

Fixtures with PAR38 LED lamp will be shipped with fixture loose, not installed.
Lamps not sold separately.

Features

- 120 Volt
- PAR38L LED
- 18 total watts

Housing

Single-piece compression molded, fiberglass reinforced polyester composite housing. Separate sealed compartments. Potted factory seal with anti-wicking wiring. Hinged lens ring with captive lens and fasteners. Only two fasteners required to secure lens ring. UL Listed silicone-filled wire nuts provided—no encapsulant required.

Trim ring

Natural cast bronze. Secured with stainless steel screws (supplied standard).

Rock guard

Natural cast bronze. Secured with stainless steel screws (sold separately).

Half dome

Field adjustable for directional glare control. Natural cast bronze. Secured with stainless steel screws (sold separately).

Lens

Clear convex, tempered borosilicate for high-impact resistance. 3,000lb live-load rated, drive-over.

LED lamp

- 25,000 hours life (no mercury).
- 19W lamp with 15° or 25° beam spread (only sold integral to i3.5 fixture).
- Color temp. (CCT): warm white (3,000K nominal).

Socket

Incandescent, PAR38 and MH E-17: 4kv rated medium base porcelain socket..

Optics

Available with spot, narrow flood or flood beam pattern. EnduraLED lamps: spot or flood beam pattern.

Gasket

Single-piece wrap around molded 100% silicone for lens assembly. Gasket for J-box cover is single-piece die-cut neoprene.

LED module

4,000K CCT or 3,000K CCT. Approx. 50,000 hours of operational life (at 25°C ambient temperature and 70% lumen maintenance). >80CRI.

Aiming

15° either side of vertical and full 360° rotation. Angle degree marks for precise vertical aiming with tool-less aiming.

ADA compliant

Compliant when used in concrete and flush-mounted with CPS35.

Electrical

LED module is a key-slotted ballast assembly with quick disconnects mounted to cast aluminum bracket for easy maintenance. e-Vision electronic ballasts automatically detect 120-277 volts, 50/60 Hz, HPF. Ballasts provide ± 5% lamp power regulation with ± 10% input voltage regulation. Incandescent (MR16) - utilizes stepdown transformer.

IP66/68 rating

Dust-tight and dual rated – sealed against direct jets of water and against continuous immersion up to a depth of 1 meter (3.28 feet).

Labels

ETL and cETL listed.



N Cast Bronze

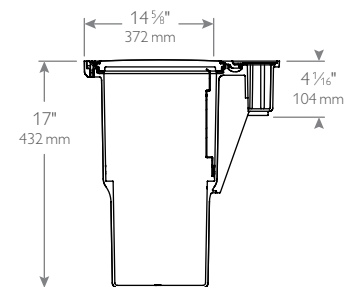

LED In-ground lighting

iT216

Composite Inground with Trim Ring



- N** Natural Cast Bronze
- H** Bronze

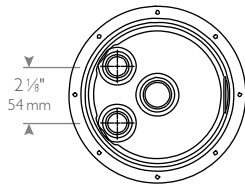
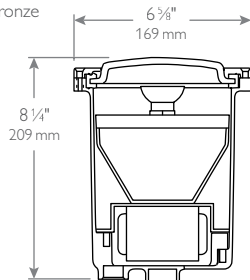

Series	Guard	Finish	Lamping	Optics	CCT
iT216	<input type="checkbox"/>	<input type="checkbox"/>	<input type="checkbox"/>	<input type="checkbox"/>	<input type="checkbox"/>
iT216 Composite Inground	- None	N Natural Cast Bronze H Bronze	LED7 7W	NF Narrow Flood FL Flood	W Warm
	G Rock Guard	H Bronze	LED7 7W	NF Narrow Flood FL Flood	W Warm

Fixture will be shipped with lamp installed. Lamp not sold separately.

Features

- 120 Volt
- MR16 LED Lamp

Housing

Single-piece compression molded, fiberglass reinforced polyester composite housing.

Trim ring

Compression molded polyester, or die-cast natural cast bronze.

Rock guard

Directional for glare control. Compression molded polyester.

Lens

Clear convex, tempered soda-lime glass for high impact resistance. 2,200 lb live-load rated, standard walkover.

LED

- 7W lamp with 25° or 35° beam spread (only sold integral to iT216 fixture).
- Color temp. (CCT): warm white (3,000 nominal) or
- 25,000 hours life (no mercury).

Aiming

15° either side of vertical and full 360° rotation. Angle degree marks for precise vertical aiming with tool-less aiming.

Electrical

Integral electronic transformer converts 120v to 12v.

Labels

ETL and cETL listed.

Configurations

With and without rock guard option.



iT216G-H
Bronze Finish with Rock Guard



iT216-N
Natural Cast Bronze Finish

LED In-ground lighting

i3

Composite Inground with Trim Ring

Series	Guard	Finish	Lamping	Optics	CCT
i3	<input type="checkbox"/>	<input type="checkbox"/>	<input type="checkbox"/>	<input type="checkbox"/>	<input type="checkbox"/>
i3 Composite Inground	- None G Rock Guard	N Natural Cast Bronze SS Stainless Steel* H Bronze	LED7 8W	NF Narrow Flood	W Warm C Cool

Fixture will be shipped with lamp installed. Lamp not sold separately.
* Rock Guard (G) not compatible with Stainless Steel (SS) Finish configuration.

Features

- 120 Volt
- PAR20 LED Lamp

Housing

Single-piece compression molded, fiberglass reinforced polyester composite housing.

Trim ring

Compression molded polyester, or die-cast stainless steel or natural cast bronze. All trim rings are secured with stainless steel screws.

Rock guard

Directional for glare control. Compression molded polyester or natural cast bronze.

Lens

Clear convex, tempered soda-lime glass for high impact resistance. 2,200lb live-load rated, standard walkover.

LED

- 8W lamp with 25° beam spread (only sold integral to i3 fixture).
- Color temp. (CCT): warm white (2,700 nominal) or cool white (4,000K nominal for 7W only).
- 25,000 hours life (no mercury).

Aiming

15° either side of vertical and full 360° rotation. Angle degree marks for precise vertical aiming with tool-less LOC-AIM®.

Electrical

Standard quad-volt core and coil mounted on key-slotted removable tray with quick connect harness.

IP66/68 rating

Dust-tight and dual rated – sealed against direct jets of water and against continuous immersion up to a depth of 1 meter (3.28 feet).

Labels

ETL and cETL listed.



i3G-HLED7NFC

- N Natural Cast Bronze
- SS Stainless Steel
- H Bronze

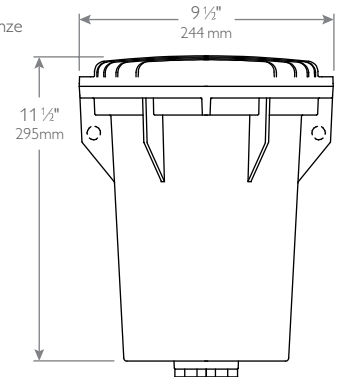

i3 shown in photograph

LED In-ground lighting

SL-23 Inground



Series	Finish	Optics	CCT	Voltage	Current
SL-23	<input type="checkbox"/>	<input type="checkbox"/>	<input type="checkbox"/>	<input type="checkbox"/>	350
SL-23 Inground	BK Black BZ Bronze WH White GR Green GY Gray NA Natural Aluminum CC Custom Color	SP Spot NF Narrow Flood FL Flood	W Warm C Cool	120 120V 208 208V 240 240V 277 277V	350 350A

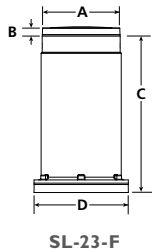

Dimensions Luminaire	A		B		C		D		Weight	
	Inch	mm	Inch	mm	Inch	mm	Inch	mm	lbs.	kg
SL-23-F	6.95	177	0.75	19	14.1	358	8.5	216	19.0	8.6

Housing

Compression molded Rhinolite™ composite material, structurally reinforced with glass fibers. Superior resistance to ultraviolet degradation and corrosion resistant in harsh environments. Trim Ring (TR) and Debris Cover (DC) supplied standard.

Splice Compartment

Supplied with two 3/4" NPT conduit entrances. Connection to ballast compartment by way of anti-wicking device. Sealed with gasketed die cast aluminum cover plate. Suitable for through wiring.

Optics

Available with spot, narrow flood, or flood beam patterns.

LED Module

3000K or 4000K CCT. 17 total watts consumed. Approximately 50,000 hours of operation life @ 25C ambient temperature and 70% lumen maintenance.

Electrical

e-Vision electronic ballasts automatically detect 120-277 volts 50/60 Hz.

Lens Frame

Heavy duty die cast bronze lens frame is supplied as standard. Fastened to housing with six captive 10-24 stainless steel Allen cap screws.

Lens

Standard 3/8" clear tempered flat borosilicate glass (F) or ADA anti slip and walkover clear tempered flat borosilicate glass (ADA). Flat lenses will withstand loads up to 200 PSI. Sealed to housing with high temperature injection molded silicone gasket. Optional linear spread lens also available.

Finish

Housing is black. Options can be painted in standard or custom colors. Powder coat is standard.

Labels

ETL and CETL listed for wet location, direct burial, and concrete pour. Certified to IP65 and IP67 to ensure protection against the harshest environments. IEC compliant versions available, consult factory.

Caution: Care should be taken when specifying fixtures for use in pedestrian walkways to avoid problems that may be caused by high lens temperatures. Consult factory for more information. Care should be taken not to install in-ground fixtures in areas where water can stand for prolonged periods of time. Sufficient drainage must be provided to avoid problems. Consult factory for more information.

LED In-ground lighting

SL-25 Inground

Series	Finish	Optics	CCT	Voltage	Curent	Mounting
SL-25						
SL-25 Inground	BK Black BZ Bronze WH White GR Green GY Gray NA Natural Aluminum CC Custom Color	SP Spot NF Narrow Flood FL Flood	W Warm C Cool	120 120V 208 208V 240 240V 277 277V	350 350A	DB-12* 12" Direct Burial DB-24* 24" Direct Burial

* Height above grade. All units include an extra 18"/457mm of tube for direct burial.

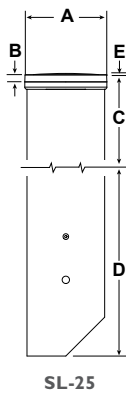

Dimensions	A		B		C		D		Weight	
Luminaire	Inch	mm	Inch	mm	Inch	mm	Inch	mm	lbs.	kg
SL-24-F	6.95	177	0.75	19	30.0	762	18.0	457	20.0	9



LED Line Voltage

Housing

Direct Burial: 6 5/8" diameter direct burial pipe with provision for anti-rotation device.

Lamp & Ballast: Low copper heavy duty cast aluminum.

Splice Compartment Supplied with two 3/4" NPT conduit entrances. Connection to ballast compartment by way of anti-wicking device. Sealed with gasketed die cast aluminum cover plate. Suitable for through wiring.

Lens Frame

Heavy duty die cast bronze lens frame is supplied as standard. Fastened to housing with six captive 10-24 stainless steel Allen cap screws.

Lens

Standard 3/8" clear tempered flat borosilicate glass. Flat lens will withstand loads up to 200 PSI. Sealed to housing with high temperature injection molded silicone gasket.

Optics

Available with spot, narrow flood or flood beam pattern.

LED Module

4000K or 3000K CCT, 12 total Watts consumed. Approx. 50,000 hours of operation life @ 25°C ambient temperature and 70% lumen maintenance.

Finish

Housing is black. Lens frame can be painted in standard or custom colors. Powder coat is standard.

Labels

ETL and CETL listed for wet location, direct burial, and concrete pour. Certified to IP65 and IP67 to ensure protection against the harshest environments. IEC compliant versions available, consult factory.

Caution: Care should be taken when specifying fixtures for use in pedestrian walkways to avoid problems that may be caused by high lens temperatures. Consult factory for more information. Care should be taken not to install in-ground fixtures in areas where water can stand for prolonged periods of time. Sufficient drainage must be provided to avoid problems. Consult factory for more information.

LED In-ground lighting

SL-33

Inground



Series	Finish	Optics	CCT	Voltage	Current
SL-33	<input type="checkbox"/>	<input type="checkbox"/>	<input type="checkbox"/>	<input type="checkbox"/>	<input type="checkbox"/>
SL-33 Inground	BK Black BZ Bronze WH White GR Green GY Gray NA Natural Aluminum CC Custom Color	SP Spot NF Narrow Flood FL Flood	W Warm C Cool	120 120V 208 208V 240 240V 277 277V	350 350A 530 530A

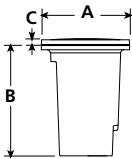

SL-33

Dimensions Luminaire	A		B		C		Weight	
	Inch	mm	Inch	mm	Inch	mm	lbs.	kg
SL-33	8.75	222	11.32	287	1.43	37	16.0	7.2

Housing

Compression molded Rhinolite composite material, structurally reinforced with glass fibers. Superior resistance to ultraviolet degradation and corrosion resistant in harsh environments. Trim Ring (TR) and Debris Cover (DC) supplied standard.

Splice Compartment

Supplied with two 3/4" NPT conduit entrances. Connection to ballast compartment by way of anti-wicking chamber. Sealed with gasketed aluminum cover plate. Suitable for through wiring.

Lens Frame

Heavy duty die cast bronze lens frame is supplied as standard. Fastened to housing with six captive 10-24 stainless steel Allen cap screws.

Lens

Standard 7/16" clear tempered flat borosilicate glass (F). All flat lenses will withstand loads up to 200 PSI. Sealed to housing with high temperature injection molded silicone gasket. Optional flat ADA anti slip and walkover lens (ADA), flat wall wash lens (WW) and 1/4" clear tempered convex borosilicate glass lens (C).

LED Module

3000K or 4000K CCT. 17 total watts consumed. Approximately 50,000 hours of operation life @ 25C ambient temperature and 70% lumen maintenance.

Electrical

e-Vision electronic ballasts automatically detect 120-277 volts 50/60 Hz.

Finish

Housing is black. Options can be painted in standard or custom colors. Powder coat is standard.

Labels

ETL and CETL listed for wet location, direct burial, and concrete pour. Certified to IP65 and IP67 to ensure protection against the harshest environments. IEC compliant versions available, consult factory.

LED In-ground lighting

SL-34 Inground



Series	Finish	Optics	CCT	Voltage	Current	Mounting
SL-34	<input type="checkbox"/>	<input type="checkbox"/>	<input type="checkbox"/>	<input type="checkbox"/>	350	<input type="checkbox"/>
SL-34 Inground	BK Black BZ Bronze WH White GR Green GY Gray NA Natural Aluminum CC Custom Color	SP Spot NF Narrow Flood FL Flood	W Warm C Cool	120 120V 208 208V 240 240V 277 277V	350 350A	DB-12* 12" Direct Burial DB-24* 24" Direct Burial

* Height above grade. All units include an extra 18"/457mm of tube for direct burial.

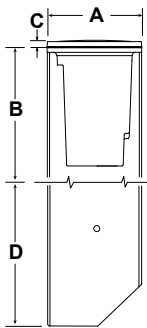

SL-34

Dimensions Luminaire	A		B		C		D		Weight	
	Inch	mm	Inch	mm	Inch	mm	Inch	mm	lbs.	kg
SL-34	8.75	222	30	762	1.43	37	18	457	24.0	10.8

Housing

Compression molded Rhinolite™ composite material, structurally reinforced with glass fibers. Superior resistance to ultraviolet degradation and corrosion resistant in harsh environments. Trim Ring and Debris Cover supplied standard.

Splice Compartment

Supplied with two 3/4" NPT conduit entrances. Connection to ballast compartment by way of anti-wicking device. Sealed with gasketed die cast aluminum cover plate. Suitable for through wiring.

Lens Frame

Heavy duty die cast bronze lens frame is supplied as standard. Fastened to housing with six captive 10-24 stainless steel Allen cap screws.

Lens

Standard 3/8" clear tempered flat borosilicate glass. Flat lens will withstand loads up to 200 PSI. Sealed to housing with high temperature injection molded silicone gasket.

Optics

Available with spot, narrow flood or flood beam pattern.

LED Module

4000K or 3000K CCT, 12 total Watts consumed. Approx. 50,000 hours of operation life @ 25°C ambient temperature and 70% lumen maintenance.

Electrical

Electronic ballasts automatically detect 120-277 volts 50/60 Hz.

Finish

Housing is black. Lens frame can be painted in standard or custom colors. Powder coat is standard.

Labels

ETL and CETL listed for wet location, direct burial, and concrete pour. Certified to IP65 and IP67 to ensure protection against the harshest environments. IEC compliant versions available, consult factory.

LED In-ground lighting

SL-43 Inground



Series	Finish	Optics	CCT	Voltage	Current
SL-43	<input type="checkbox"/>	<input type="checkbox"/>	<input type="checkbox"/>	<input type="checkbox"/>	<input type="checkbox"/>
SL-43 Inground	BK Black BZ Bronze WH White GR Green GY Gray NA Natural Aluminum CC Custom Color	SP Spot NF Narrow Flood FL Flood	W Warm C Cool	120 120V 208 208V 240 240V 277 277V	350 350A 530 530A

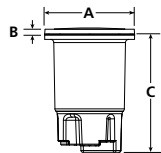

SL-43

Dimensions	A	B	C	Weight
Luminaire	Inch mm	Inch mm	Inch mm	lbs. kg
SL-43	12.25 311	0.80 20	16.0 405	26.0 11.7

Housing (Lamp/Ballast)

Compression molded Rhinolite™ composite material, structurally reinforced with glass fibers. Superior resistance to ultraviolet degradation and corrosion resistant in harsh environments. Trim Ring (TR) and Debris Cover (DC) supplied standard.

Splice Compartment

Supplied with two 3/4" NPT conduit entrances. Connection to ballast compartment by way of anti-wicking device. Sealed with gasketed die cast aluminum cover plate. Suitable for through wiring.

Lens Frame

Heavy duty die cast bronze lens frame is supplied as standard. Fastened to housing with six captive 10-24 stainless steel Allen cap screws.

Lens

Standard 3/8" clear tempered flat borosilicate glass (F) or ADA anti slip and walkover clear tempered flat borosilicate glass (ADA). Flat lenses will withstand loads up to 200 PSI. Sealed to housing with high temperature injection molded silicone gasket.

LED Module

3000K or 4000K CCT. 17 total watts consumed. Approximately 50,000 hours of operation life @ 25C ambient temperature and 70% lumen maintenance.

Electrical

e-Vision electronic ballasts automatically detect 120-277 volts 50/60 Hz.

Finish

Housing is black. Options can be painted in standard or custom colors. Powder coat is standard.

Labels

ETL and CETL listed for wet location, direct burial, and concrete pour. Certified to IP65 and IP67 to ensure protection against the harshest environments. IEC compliant versions available, consult factory.

LED In-ground lighting



LED Bollard lighting

RD6/RF6

Aluminum Bollard



Series	Finish	Optics	Wattage	CCT	Voltage
<input type="checkbox"/>	<input type="checkbox"/>	<input type="checkbox"/>	<input type="checkbox"/>	<input type="checkbox"/>	<input type="checkbox"/>
RD6 Round	A Black	KF Type V Cone	12L 9.5W (LED/Med. Socket)	W Warm	E 120V
RF6 Square	H Bronze I Grey	K5 Type V Refractor	10 25W (10 LED/Module)	W Warm	A 120V-277V
		KF Type V Cone		C Cool	

Bollard

The RD6 and RF6 bollard is now equipped with state-of-the-art LED lighting solutions that deliver a better quality of light while also providing energy savings.

Construction

1100-0 spun aluminum alloy head is secured to the bollard tube with a single stainless steel allen head screw providing easy removal for relamping. Easy access to lamp. 6" dia. extruded aluminum with a wall thickness of 0.125".

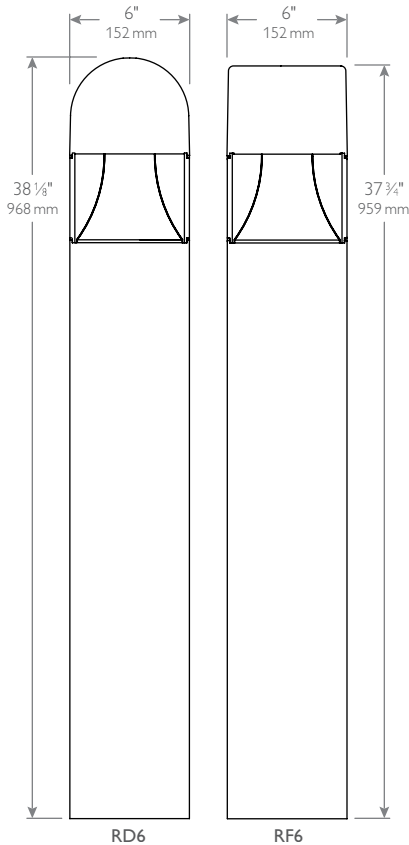

RD6
Round

RF6
Square

EnduraLED

The Philips EnduraLED A19 lamp is 2700K warm white and delivers 800 lumens and is also dimmable (consult factory for dimming capabilities).

- Lamp life is rated at 25,000 hours.
- 120V, ETL and cETL listed.

Integrated Module

- 1050 mA
- 4,000K (4K) at 100 lumen per LED or 3,000K (3K) at 66 lumen per LED (10 LEDs = 25 Watts).
- Lamp life is rated at 70,000 hours.
- Image is for reference only.

LED Bollard lighting

DB14/DB21/DB30 Aluminum Bollard

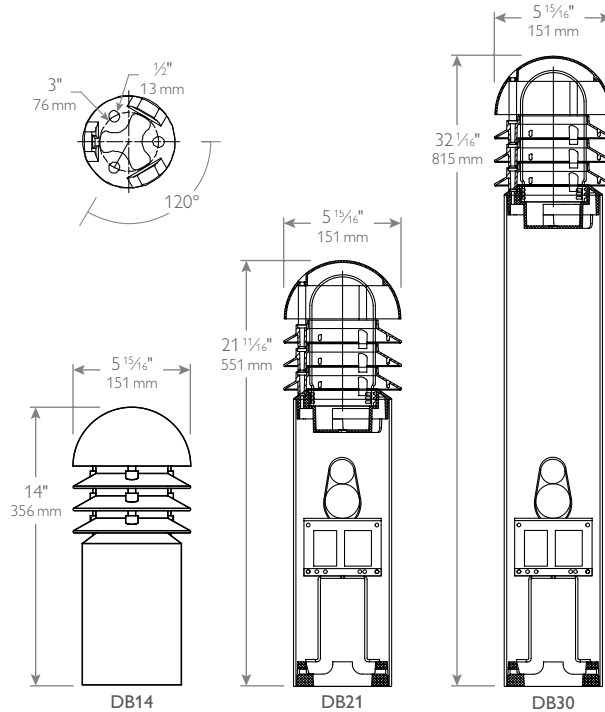

Series	Finish	Finish	Optics	Wattage	Voltage
DB	<input type="checkbox"/>	<input type="checkbox"/>	A0	12L	E
DB Aluminum Bollard	14 14" 21 21" 30 32"	A Black H Bronze	A0 Symmetric	12L 9.5W	E 120V

Upper housing

Die-cast aluminum (including louvers). Head assembly is mounted to lower housing with three (3) stainless steel screws.

Lower housing

Constructed of 5" extruded aluminum (1/8" wall).

Lens

Clear molded glass, threaded against silicone gasket for tight seal.

EnduraLED

The Philips EnduraLED A19 lamp is 2700K warm white and delivers 800 lumens and is also dimmable (consult factory for dimming capabilities).

- Lamp life is rated at 25,000 hours.
- 120V, ETL and cETL listed.

Finish

Highly weather-resistant CraftStone finish bonded to the aluminum substrate, or durable thermoset polyester powdercoat applied after a five-stage conversion cleaning process. Note: Louvers on CraftStone finishes are powdercoated white. Additional finishes, consult factory.

Socket

Incandescent and HID: medium base. Fluorescent: GX24q-3 or GX24q-4 base.

Gasket

Flat silicone gasket.

Reflector

Highly reflective white paint on spun aluminum rings, mounted on the underside of louvers.

Mounting

Lower casting is secured to anchor foundation by three (3) galvanized steel bolts and nuts. Before installing anchor bolts, contact factory for latest mounting template.

Voltage Caution

Some local interpretation of the NEC Section 210-6 only permits the use of 120 volt fixtures when mounted below 8'. Check with local authorities before specifying alternate voltages.

Electrical

Standard quad-volt core and coil mounted on removable ballast bracket, with quick connect harness, high power factor, dipped in moisture-resistant epoxy coating. Fluorescent uses electronic ballasts.

Labels

ETL and cETL listed.



LED Residential lighting

Palermo

Residential lighting

Features

- B57400 = medium fixture
B57600 = large fixture
- Cast aluminum construction.
- All finishes available*
- Clear, frosted, thumb print and linen globes available.

Panels/Lens/Globe

Precision designed, glass globe: linen, thumb print, frosted and clear glass available. Linen Glass Globe (U) is standard.

Lamping

12 total watts consumed; running at 700 mA. 4,000K (4K) color temperature, delivering 100 lumen per LED or 3,000K (3K) delivering 66 lumen per LED (10 LED's). Based on in-situ thermal testing and data from Philips Lumileds and Philips Advance, fixture can be expected to reach 55,000 hours (at >L70 lumen maintenance @ 25°C).

Electrical

Smart Select™ Electronic Driver; 120-277 VAC, 50-60Hz, Auto-sensing. 6kV Surge protection. -40°C to ±50°C Operating temperature. Fixture is pre-wired with 18 AWG black, white, and ground wires. Lantern will be prewired and tested.

Labels

ETL listed.

*See Finishes & Materials in the Quick references section at the beginning of the catalog for Residential finishes.



B57410
Antique Brass

B57660
Antique Brass

2	B57660	LED	ABS	G	W
①	②	③	④	⑤	⑥
1. Quantity	2. Model Number	3. Lamp Source	4. Finish Code	5. Panel/Globe Code	6. Wattage, Lamping or other Options

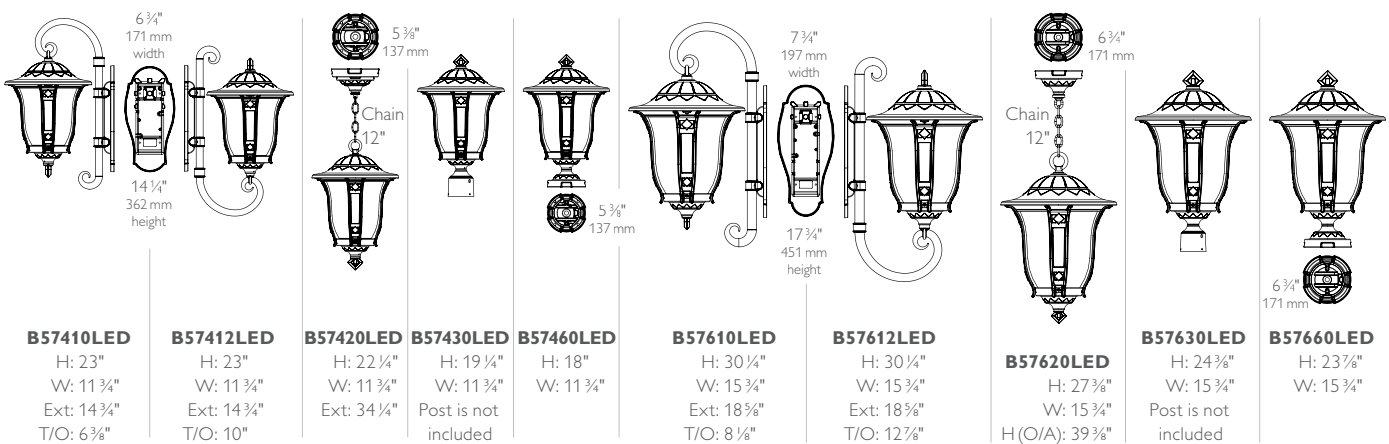

LED Residential lighting

Riviera Residential lighting



Features

- B5800 = medium fixture
- All finishes available*
- Clear, frosted, thumb print and linen globes available.
- Cast aluminum construction.

Panels/Lens/Globe

Precision designed, glass globe: linen, thumb print, frosted and clear glass available. Linen Glass Globe (U) is standard.

Lamping

12 total watts consumed; running at 700 mA, 4,000K (4K) color temperature, delivering 100 lumen per LED or 3,000K (3K) delivering 66 lumen per LED (10 LED's). Based on in-situ thermal testing and data from Philips Lumileds and Philips Advance, fixture can be expected to reach 55,000 hours (at >L70 lumen maintenance @ 25°C).

Electrical

Smart Select™ Electronic Driver, 120-277 VAC, 50-60Hz, Auto-sensing, 6Kv Surge protection. -40°C to ±50°C Operating temperature. Fixture is pre-wired with 18 AWG black, white, and ground wires. Lantern will be prewired and tested.

Labels

ETL listed.

* See Finishes & Materials in the Quick references section at the beginning of the catalog for Residential finishes.

2 B58460 LED ASI G W S
① ② ③ ④ ⑤ ⑥ ⑦

1. Quantity
2. Model Number
3. Lamp Source
4. Finish Code
5. Panel/Globe Code
6. Wattage, Lamping or other Opts
7. Roof Scrolls

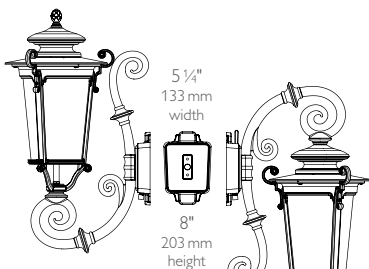

B58410LED

H: 26 3/8"
W: 11 1/4" dia. or 12 3/4" dia. with scrolls
Ext: 16" or 16 3/8" with scrolls
T/O: 17 3/8"

B58412LED

H: 26 3/8"
W: 11 1/4" dia. or 12 3/4" dia. with scrolls
Ext: 16" or 16 3/8" with scrolls
T/O: 9 1/2"



B58420LED

H: 24 1/2"
W: 11 1/4" dia or 12 3/4" dia with scrolls
H(O/A): 37 1/4"



B58430LED

H: 27 3/8"
W: 11 1/4" dia. or 12 3/4" dia. with scrolls
Post is not included

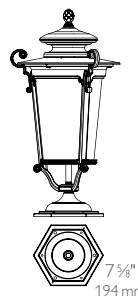

B58460LED

H: 22 3/8"
W: 11 1/4" dia. or 12 3/4" dia. with scrolls

LED Residential lighting

Manor

Residential lighting

Features

- Cast aluminum construction with painted finials and spindles.
- All panels and finishes available*
- Clear acrylic panels (except where noted not available).
- Porcelain medium base socket with painted socket cover.
- Higher wattages may be used only with glass panels installed.

Lamping

4,000K (4K) color temperature or 3,000K (3K). Lumileds Rebel LEDs (2) 10 up boards (100 lumens per watt each LED) on aluminum core PCB. Cast aluminum heat sink with sealed lens.

Ballast

Smart select electronic 25 watts, 700MA, 36-volt driver 120-277 VAC; 50-60 Hz; auto sensing with internal 6kv surge protection.

Electrical

Fixture is pre-wired with 18 AWG black, white, and ground wires. Lantern will be prewired and tested.

Labels

ETL listed.

*See Finishes & Materials in the Quick references section at the beginning of the catalog for Residential finishes.



LED Residential lighting

Manor Residential lighting

B4100 series (medium 100w max.)



B4101
H: 14 3/4"
W: 11 3/4"
Ext: 11 1/4"
T/O: 10 5/8"



B4110
H: 19 3/4"
W: 11 3/4"
Ext: 12 1/2"
T/O: 12 1/4"



B4113*
H: 19 3/4"
W: 11 3/4"
Ext: 12 1/2"
T/O: 12 1/4"



B4115
H: 27 3/8"
W: 11 3/4"
Ext: 12 1/2"
T/O: 12 1/4"



B4118*
H: 27 3/8"
W: 11 3/4"
Ext: 12 1/2"
T/O: 12 1/4"



B41FRM*
H: 17"
W: 11 3/4"
Ext: 15 1/8"
T/O: 10"



Optional: 3-light painted candelabra candle cluster (25w max. per socket).



B4120
H: 13 1/2"
W: 11 3/4"
H(O/A): 42 3/4"



B2550*
H: 14 3/8"
W: 11 3/4"



B4130
H: 18 1/2"
W: 11 3/4"
Post is not included.



B4131*
H: 18 1/2"
W: 11 3/4"
Post is not included.

B5500 series (large 100w max.)



B5501*
H: 22 3/4"
W: 13 3/4"
Ext: 13 1/4"
T/O: 14 3/4"



B5501-1*
H: 27 3/4"
W: 13 3/4"
Ext: 13 1/4"
T/O: 14 3/4"



B5510
H: 29 5/8"
W: 13 3/4"
Ext: 13 3/8"
T/O: 22 1/2"



B5513*
H: 29 5/8"
W: 13 3/4"
Ext: 13 3/8"
T/O: 22 1/2"



B5515
H: 42 1/4"
W: 13 3/4"
Ext: 13 3/8"
T/O: 22 1/2"



B5518*
H: 42 1/4"
W: 13 3/4"
Ext: 13 3/8"
T/O: 22 1/2"



B55FSM*
H: 30"
W: 13 3/4"
Ext: 16 1/4"
T/O: 20"



B55FRM
H: 24 1/2"
W: 13 3/4"
Ext: 16 1/8"
T/O: 10"

3-light only



B5520
H: 22 3/4"
W: 13 3/4"
H(O/A): 50"



B5521**
H: 28 1/8"
W: 13 3/4"



B5530
H: 28 3/8"
W: 13 3/4"
Post is not included.



B5531*
H: 28 3/8"
W: 13 3/4"
Post is not included.

B5550
H: 29 5/8"
W: 71"
Ext: 13 3/8"
T/O: 13 1/8"

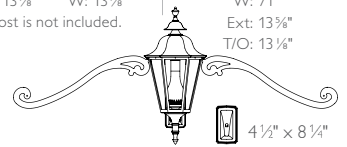

B6100 series (extra large 200w max.)



B6117
H: 40 3/4"
W: 21 1/4"
Ext: 23 3/8"
T/O: 32 3/8"



B6118
H: 52"
W: 21 1/4"
Ext: 23 3/8"
T/O: 32 3/8"



B61FSM
H: 39 3/4"
W: 21 1/4"
Ext: 21 3/4"
T/O: 27 1/4"



B61FRM
H: 33 1/4"
W: 21 1/4"
Ext: 21 3/4"
T/O: 12 1/2"

3-light only



B6120
H: 30 1/4"
W: 21 1/4"
H(O/A): 50"



3-light only



B6160
H: 43 3/8"
W: 21 1/4"



B6130
H: 40 1/2"
W: 21 1/4"

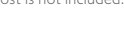

Standard: Clear acrylic panels and frosted chimney - glass not available.
Optional: 4-light painted candelabra candle cluster (25w max. per socket).

* Clear beveled glass panels.

** Frosted glass panels are standard and chimney NOT available.

Low Voltage Concrete Installation

Installation of inground fixtures requires special consideration. Proper grading, drainage material and tightly securing the lens and gasket are procedures that are key to a successful inground installation. The following are basic steps in installing inground fixtures in either concrete (using the concrete pour accessory) or soil. For greater detailed instructions, refer to the installation sheet enclosed with each fixture.

Installation process

1. Remove trim ring and lens and install specified lamp. Replace trim ring and lens.
2. Position the fixture housing into the concrete pour accessory, making sure that the underside of the housing flange rests on top of the set screws. Tighten set screws on side of accessory to lock the housing into place (do not over-tighten). Secure assembly to the final location with re-bar or other anchoring device.
3. Excavate soil where the fixture is to be installed.
4. Place assembly into excavated opening. Be sure there is a minimum of 3" of drainage material (sand or gravel only) covering the bottom of the hole.
5. Fill area with a minimum of 3" of drainage material. Be sure not to fill area flush with top of frame and assembly. This is to be filled with concrete.
6. Connect low voltage fixture wire to low voltage cable running to remote transformer, using silicone wire nuts or quick connector (supplied).
7. Pour concrete. Remember that fixture position cannot be altered after the concrete sets.
8. Turn power on at transformer.

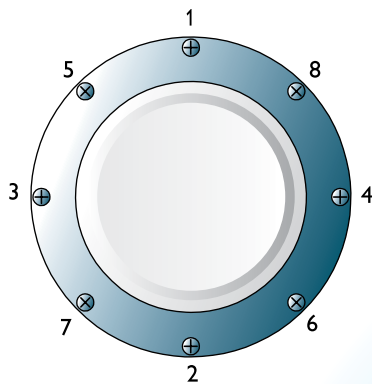

Order in which to tighten screws.

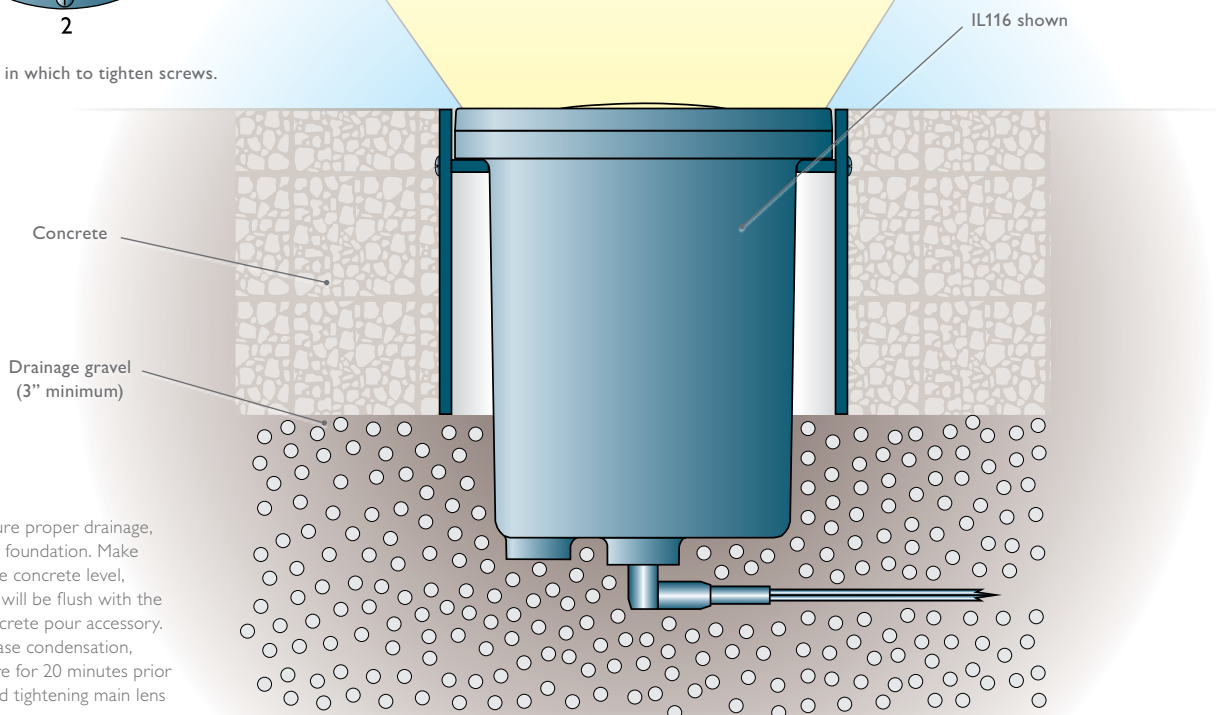

Note: To ensure proper drainage, prepare gravel foundation. Make certain that the concrete level, when poured, will be flush with the top of the concrete pour accessory. To help decrease condensation, energize fixture for 20 minutes prior to installing and tightening main lens and retainer ring.

Low Voltage Ground Installation

Installation process

1. Excavate soil for fixture placement and conduit runs, making sure the fixture will be elevated and the grade sloped down from the fixture. Be certain to allow a minimum of 3" of drainage material (sand or gravel only) under and around the housing.
2. Remove trim ring and lens and install specified lamp. Replace trim ring.
3. After drainage material is installed in the bottom, place fixture housing into hole, back-filling a minimum of 3" of drainage material (sand or gravel only) around the side of the housing. Be certain that the underside of housing flange rests on top of grade level.
4. Connect low voltage fixture wire to low voltage cable running to remote transformer, using silicone wire nuts or quick connector (supplied).
5. Turn power on at transformer.



Ground Installation

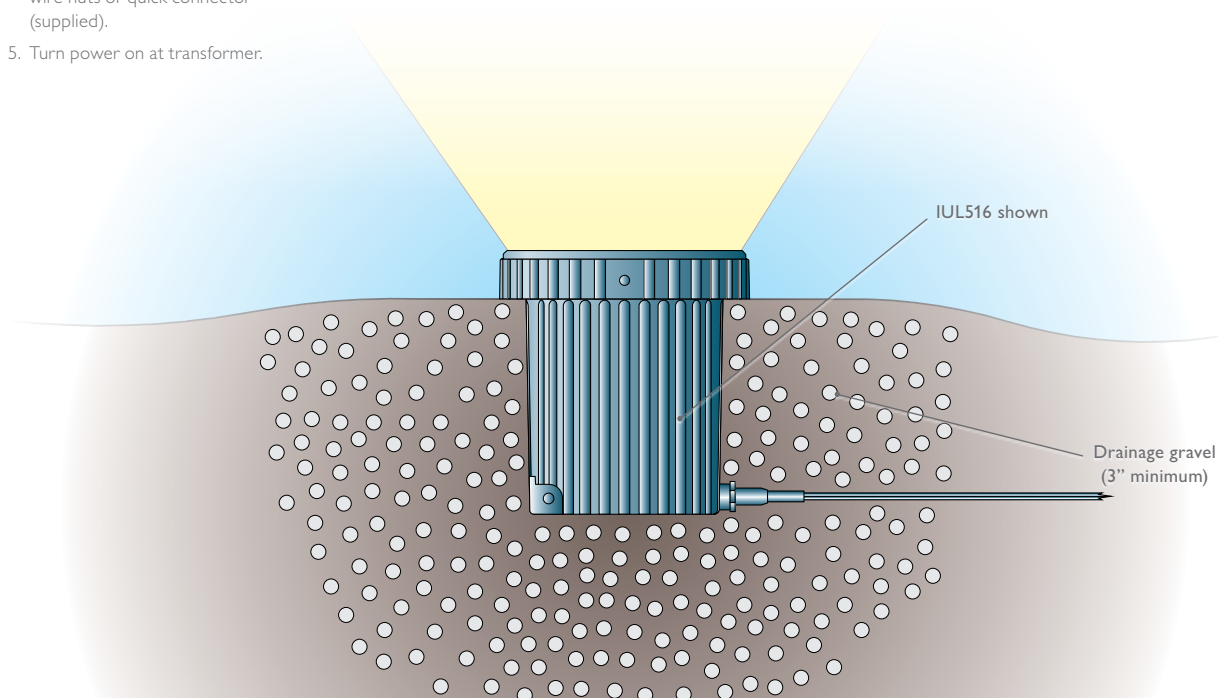

Note: Do not place fixture in a below grade location as the fixture will collect dirt and debris, and possibly become submerged in extremely wet conditions. Do not place plantings too close to the fixture as the foliage may grow over the luminaire, blocking the light. Do not allow mulch to touch inground fixture in any way as this may cause the fixture to overheat and fail.

Line Voltage Concrete Installation

Installation of inground fixtures requires special consideration. Proper grading, drainage material and potting of internal wires are procedures that are key to a successful inground installation. The following are basic steps in installing inground fixtures in either concrete (using the concrete pour accessory) or soil installation. For greater detailed instructions, refer to the installation sheet enclosed with each fixture.

Installation process

1. Remove trim ring and all internal components from fixture housing, except for the moisture absorbing desiccant pack attached to the side of the housing. Set aside.
2. Position the fixture housing into the concrete pour accessory, making sure that the underside of the housing flange rests on top of the set screws. Tighten set screws on side of accessory to lock the housing into place (do not over-tighten). Secure assembly to the final location with re-bar or other anchoring device.
3. Excavate soil where the fixture is to be installed. Dig a trench 18" deep for conduit installation.
4. Place assembly into hole. Be sure there is a minimum of 3" of drainage material (sand or gravel only) covering the bottom of the hole.
5. Install the conduit to housing using a watertight fitting (by others), and pull supply wires through into housing.
6. Press duct seal compound (by others) into wire entryway, and then fill the entire entryway with two-part potting compound (supplied with select fixtures) to seal the conduit entry point from moisture.
7. Place the dirt cover on the fixture to prevent gravel and concrete from falling into the fixture housing.
8. Fill area with a minimum of three 3" of drainage material. Be sure not to fill area flush with top of frame and assembly. This is to be filled with concrete.
9. Pour concrete. Remember that fixture position cannot be altered after the concrete sets.
10. Once the concrete has set and is completely cured, remove dirt cover from fixture and install electrical components. Use silicone wire nuts (by others) to connect supply wire to fixture wire, within housing.
11. Install specified lamp, and then replace gasketed lens, making certain there is no debris between the gasket and the housing. Install trim ring or rock guard per installation instructions.
12. Connect fixture to power source and energize.

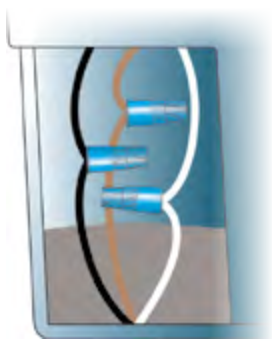

Wires must be connected with silicone wire nuts and compartment must be potted.

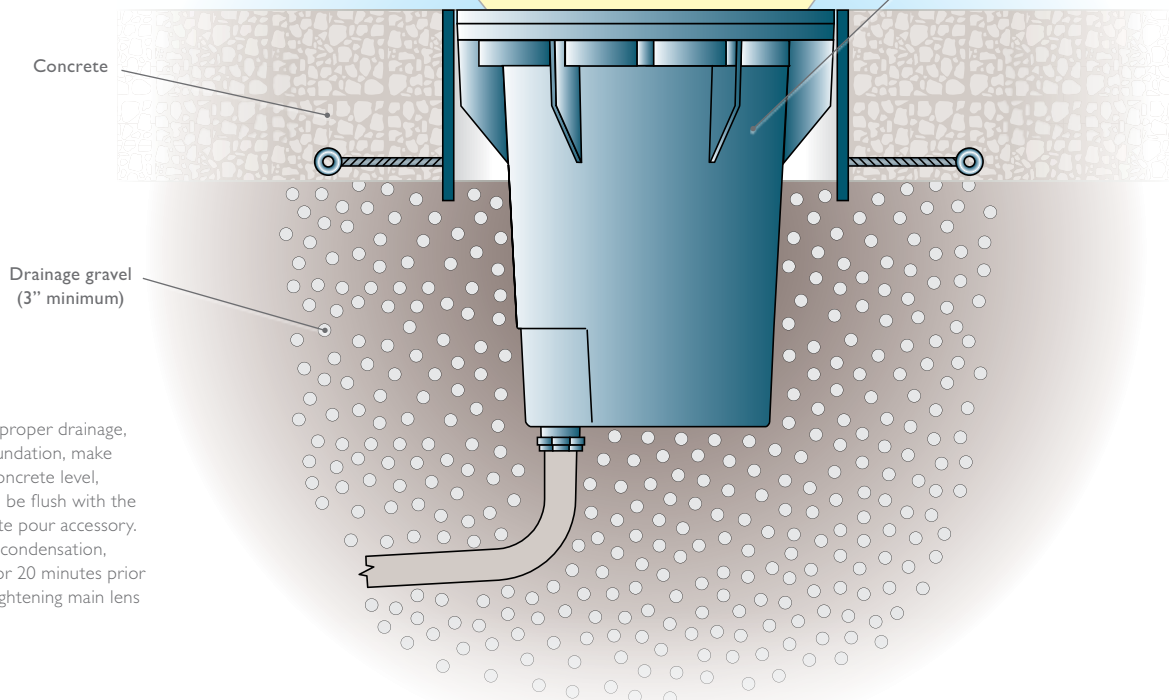

Note: To ensure proper drainage, prepare gravel foundation, make certain that the concrete level, when poured, will be flush with the top of the concrete pour accessory. To help decrease condensation, energize fixture for 20 minutes prior to installing and tightening main lens and retainer ring.

Line Voltage Ground Installation

Installation process

1. Excavate soil for fixture placement and conduit runs, making sure the fixture will be elevated and the grade sloped down from the fixture. Be certain to allow a minimum of 3" of drainage material (sand or gravel only) under and around the housing.
2. Remove trim ring and all internal components from fixture housing, except for the moisture absorbing desiccant pack attached to the side of the housing. Set aside.
3. After drainage material is installed in the bottom, place fixture housing into hole, back-filling a minimum of 3" of drainage material (sand or gravel only) around the side of the housing. Be certain that the underside of housing flange rests on top of grade level.
4. Install the conduit to housing using a watertight fitting (by others) and pull supply wires through, into housing.
5. Press duct seal compound (by others) into wire entryway, and then fill the entire entryway with two-part potting compound (supplied with select fixtures) to seal the conduit entry point from moisture.
6. Re-install ballast tray. Use silicone wire nuts (by others) to connect supply wire to fixture wire within housing.
7. Re-install balance of electrical components. Plug lamping module into quick connect, if applicable.
8. Install specified lamp, and then replace gasketed lens, making certain there is no debris between the gasket and the housing. Install trim ring or rock guard per installation instructions.
9. Connect fixture to power source and energize.

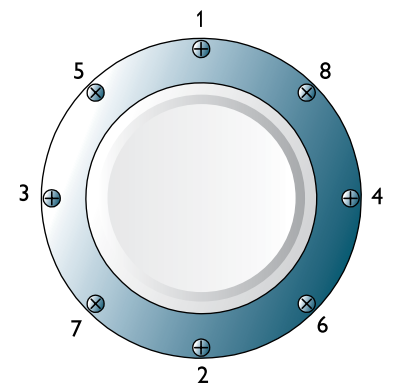

Order in which to tighten screws.

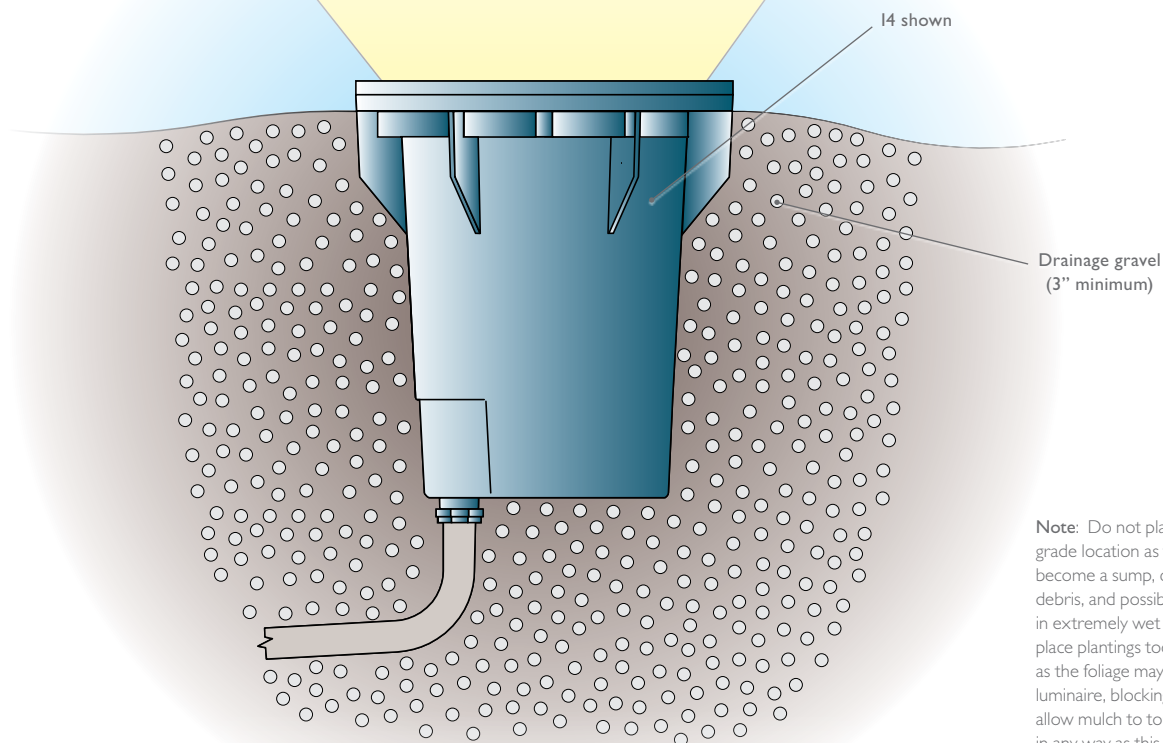

Note: Do not place fixture in a below grade location as the fixture will become a sump, collecting dirt and debris, and possibly become submerged in extremely wet conditions. Do not place plantings too close to the fixture as the foliage may grow over the luminaire, blocking the light. Do not allow mulch to touch inground fixture in any way as this may cause the fixture to overheat and fail.

Line Voltage Step light Installation

Round Aperture

New Stud Wall Installation process (use accessory kit #MAKNS)

- Using the supplied template, cut a level hole through the existing wall between studs. (Failure to level hole will cause fixture to have tilted appearance.)
- Mount L-brackets onto top and bottom of housing with screws positioned in center of slots.
- Insert cross brackets through L-brackets.
- Position fixture so the back of the finishing ring extends past the studs the thickness of the wallboard.
- Level fixture and hammer tabs on cross brackets into studs. Nail brackets securely to studs.
- Fine adjust fixture position and tighten any loose screws.
- Remove the 1/2" NPT plugs from the sides/bottom of the housing and pull the supply wire through into the housing.
- Remove finishing ring by removing flathead screws.
- Install wallboard.
- Replace finishing ring.
- Install thermal protector (attached to electrical chassis).

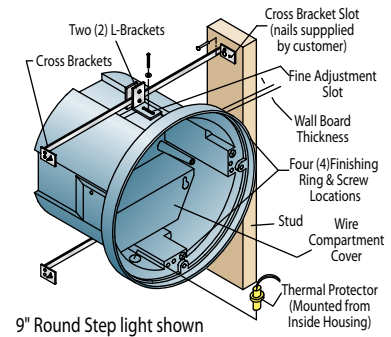

Existing Stud Wall Installation process (use accessory kit #MAKES)

- Using the supplied template, cut a level hole through the existing wall between studs. (Failure to level hole will cause fixture to have tilted appearance.)
- Push the mounting screws through the housing holes and into rear channels. (Note: a thin membrane covers the housing holes and may require forcing the screws through by tapping them lightly with a hammer.)
- Place flags flat on rear of housing. Thread screws into and through the flags.
- Remove the 1/2" NPT plugs from the sides/bottom of the housing and pull the supply wire through into the housing. (Through wiring not recommended.)
- Remove wiring compartment screw and wiring compartment from housing.
- Push housing into the hole in the wall.
- Tighten the mounting screws until the flag fasteners are drawn tight against the inner surface of the wall.
- Replace wiring compartment in its original position and replace screw.
- Install thermal protector (attached to electrical chassis).

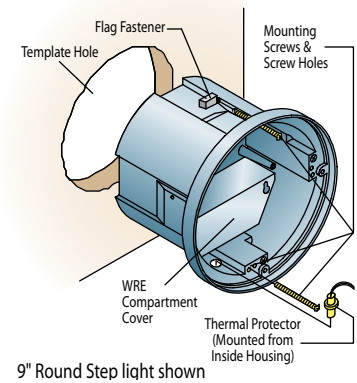

Masonry Installation process (use accessory kit #MAKM)

- Install screw through washer and lower masonry brackets and into tapped hole on bottom of the housing.
- Remove the 1/2" NPT plugs from the sides/bottom of the housing and pull the supply wire through into the housing.
- Be sure to use proper connections per NEC and local codes.
- Press housing and lower masonry brackets into the mortar so that mortar comes through the holes of the brackets.
- Continue laying block until level with the top of the fixture. Install the two upper masonry brackets into the housing as in Step 1.
- Finish laying mortar and block over top of the fixture.

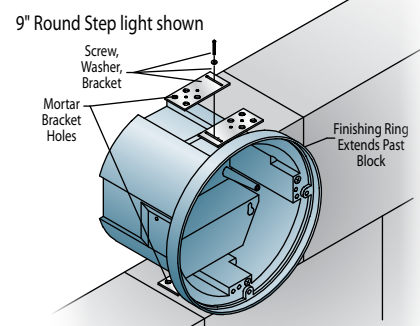

Concrete Pour Installation process (hardware included with each fixture)

- Level supplied template on wood support frame and drill 3/16" diameter clearance holes as marked.
- Remove the 1/2" NPT plugs from the sides/bottom of the housing.
- Install plastic protective shield (if supplied) into housing.
- Pull the supply wire through into the housing. (Through wiring not recommended.) Be sure all unused electrical plugs are replaced. Finishing ring may be removed now and replaced after concrete pour.
- Secure housing to wood support with screws supplied in hardware packet.
- Pour concrete.
- If finishing ring was removed, replace it and tighten flathead screws. If screws are not tight, fixture may leak.

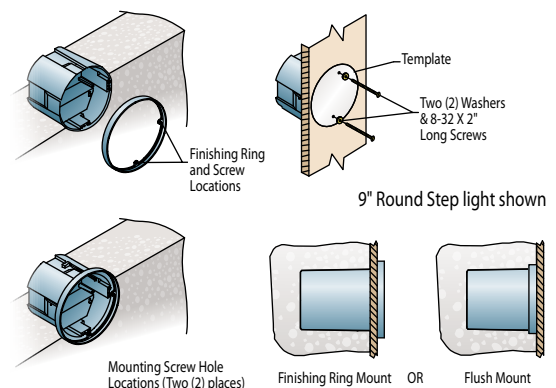

Line Voltage Step light Installation

Square Aperture

New or Existing Stud Wall Installation process (use accessory kit #MAKES)

- Using the supplied template, cut a level hole through the existing wall between studs. (Failure to level hole will cause fixture to have tilted appearance.)
- Push the four (4) mounting screws through the housing holes and into rear channels. (Note: a thin membrane covers the housing holes and may require forcing the screws through by tapping them lightly with a hammer.)
- Place flags flat on rear of housing. Thread screws into and through the flags.
- Remove the desired 1/2" NPT plugs from the side(s)/back/bottom of the housing and pull the supply wire through into the housing.
- Be sure to use proper connections per NEC and local codes.
- Push housing into the hole in the wall.
- Tighten the mounting screws until the flag fasteners are drawn tight against the inner surface of the wall.
- Install thermal protector.

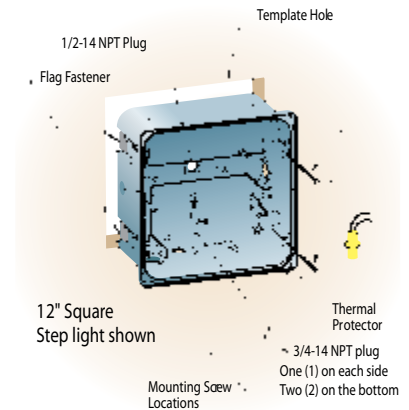

Masonry Installation process (use accessory kit #MAKM)

- Install two (2) screws through washers and lower masonry brackets and into tapped holes on bottom of the housing.
- Remove desired NPT plug(s) from the side(s)/back/bottom of the housing and pull the supply wire through into the housing.
- Be sure to use proper connections per NEC and local codes.
- Press housing with lower masonry brackets into the mortar so that mortar comes through the holes of the brackets.
- Continue laying block until level with the top of the fixture. Install the two upper masonry brackets into the housing as in Step 1.
- Finish laying mortar and block over top of the fixture.

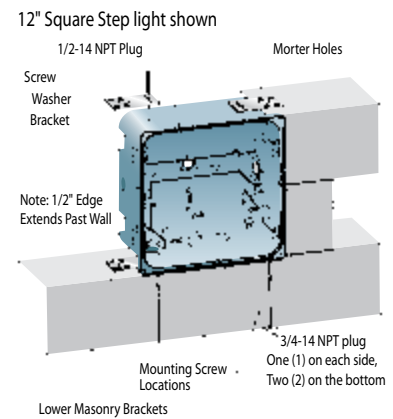

Concrete Pour Installation process (hardware included with each fixture)

- Install two (2) screws through washers and lower masonry brackets and into tapped holes on bottom of the housing.
- Remove desired NPT plug(s) from the side(s)/back/bottom of the housing and pull the supply wire through into the housing.
- Be sure to use proper connections per NEC and local codes.
- Press housing with lower masonry brackets into the mortar so that mortar comes through the holes of the brackets.
- Continue laying block until level with the top of the fixture. Install the two upper masonry brackets into the housing as in Step 1.
- Finish laying mortar and block over top of the fixture.

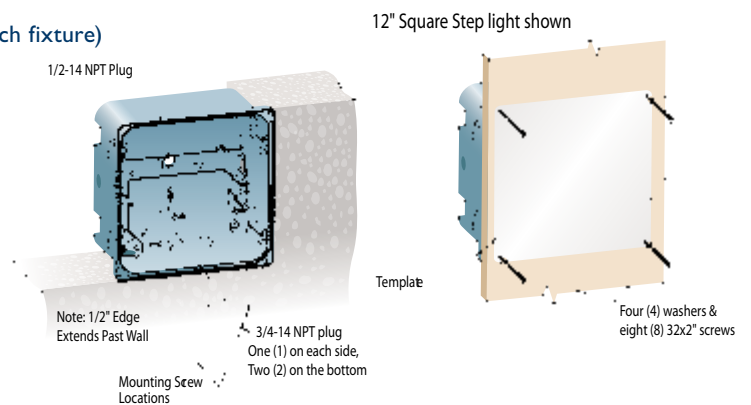

Low Voltage Pond Installation

Fixtures are intended for use in water gardens, fountains or ponds and not for use in swimming pool applications. Underwater lighting techniques may include up-lighting above-surface water features, or illuminating the water itself.

Installation process

1. Remove screw(s) and lens cover and install lamp.
2. Replace lens and cover and reinstall screw(s). Be certain that gasket area is wiped clean and is free of any debris and that screws are tightly fastened (do not overtighten).
3. Submerge fixture in water, making sure that the end of the 10-ft. SVO cord is not submerged. Fixture must be submerged a minimum of 2" below the water surface.
4. Connect dry end of SVO cord to cable run, using silicone-filled wire nuts (MA22 or similar).
5. Power supply (transformer) must be mounted in accordance to NEC specifications.
6. Do not allow the underwater fixture to freeze as this may cause fixture failure.

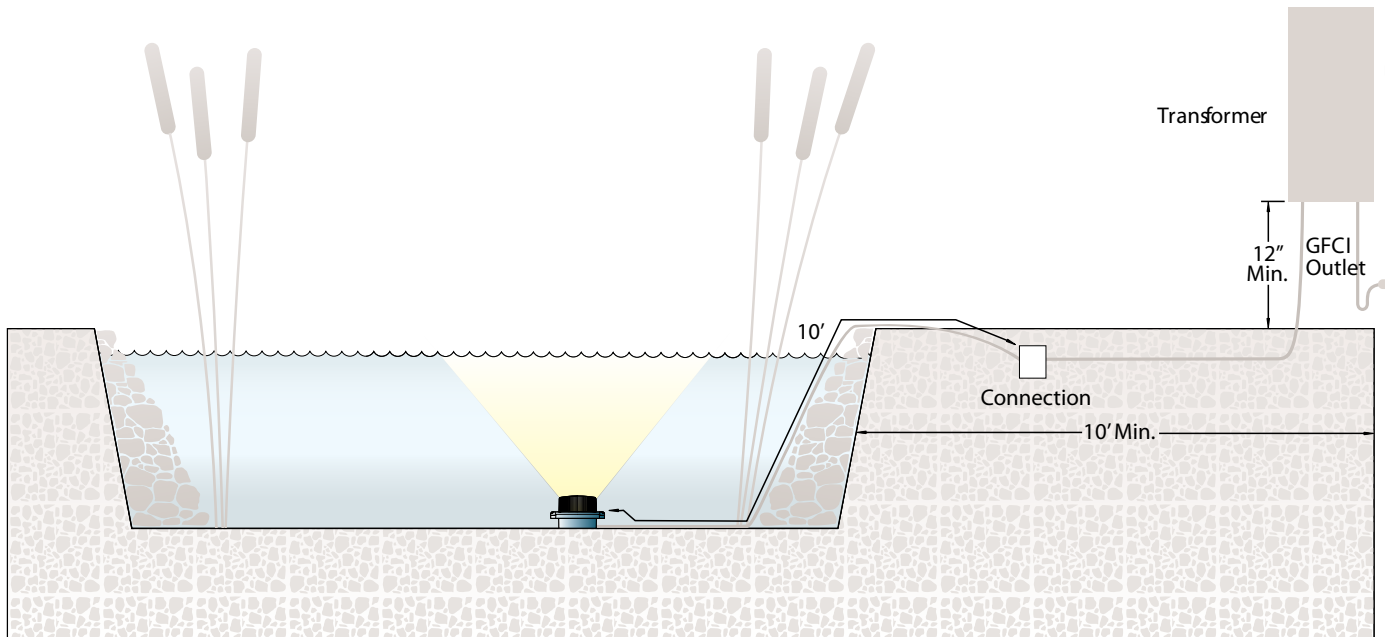

Line Voltage Waterfall and Fountain Installation

Aerated Waterfalls

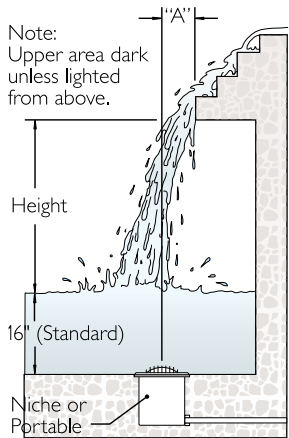

Waterfall height	A	B	C	Light spacing	Wattage required
1'	2"	NR	6"	2'	250W
2'	4"	NR	8"	2'	250W
3'	6"	16"	12"	3'	250W
4'	8"	18"	16"	3'	250W
5'	10"	20"	18"	4'	250W

NR = Not Recommended.

Sheet Waterfalls

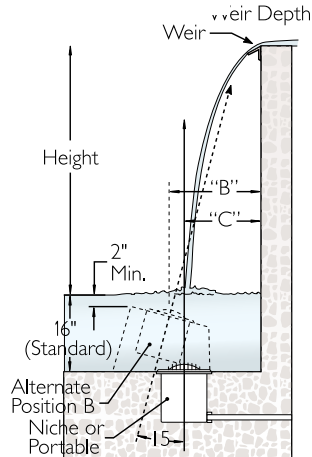

Waterfall height	A	B	C	Light spacing	Wattage required
1'	2"	NR	6"	2'	250W
2'	4"	NR	8"	2'	250W
3'	6"	16"	12"	3'	250W
4'	8"	18"	16"	3'	250W
5'	10"	20"	18"	4'	250W

NR = Not Recommended.

Fountains

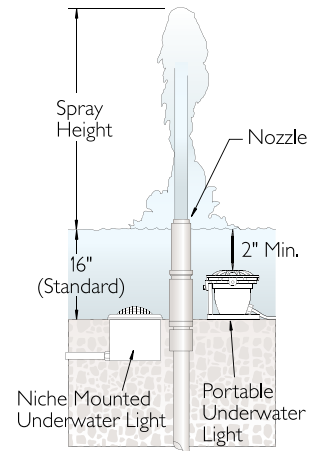

Spray height	Qty of lights	Wattage (portable)	Wattage (niche)
0-3'	1	250W	250W
3-10'	2	250W	NR
10-20'	3	250W	NR

NR = Not Recommended.

Junction Box and Fixture Installation

Base or Yoke Mount

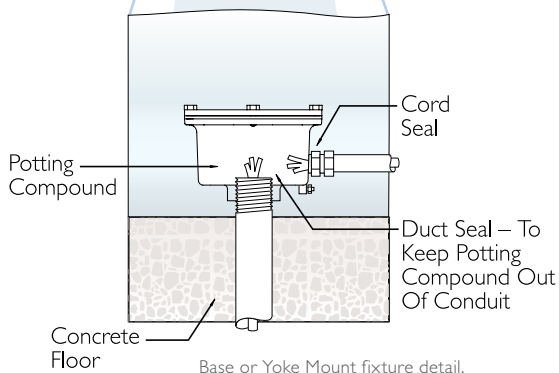
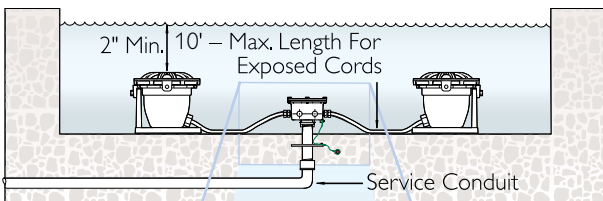

Base or Yoke Mount fixture detail.

Niche Mount/Fountains only

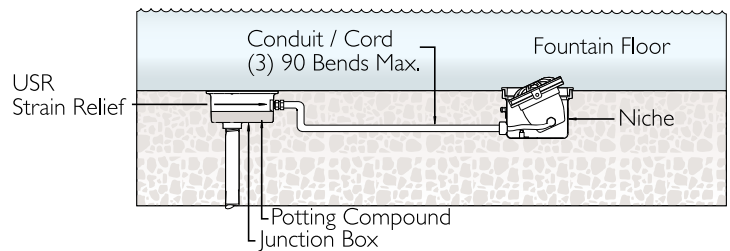

Conductor Size A.W.G.	Requires space in box for each conductor
18	1.5 CU.IN.
16	1.75 CU.IN.
14	2.0 CU.IN.
12	2.25 CU.IN.
10	2.5 CU.IN.
8	3.0 CU.IN.
6	5.0 CU.IN.

All conductors are to be considered in calculations.

LED index (chronologically listed)

LED Low Voltage

Accent lighting	16	Deck lighting	27
BL5016	16	DAL1	27
BL616	16	DCL1	27
BL9	17	DUL1	27
BUL16	18		
MA5	18	Path and walkway lighting	28
BL711	19	AL41	28
CUL16	19	CPL21	29
BL16	20	CUL2D	29
		CUL7D	30
Wall wash lighting	21	CUL9D	30
AA11D	21	CUL10D	31
AUL1D	21	CUL14D	31
		MUL4	33
Flood lighting	22	RL4	33
WAML1D	22	RL9	33
WBML1D	22	TRL4	33
Down lighting	23	Underwater lighting	34
DL1D	23	UWL1075	34
DRL1	23	UWUL516	34
DRL1D	24		
DRL2	24	Transformers	35
		Mounting Stakes	35
In-ground lighting	25		
iL1116	25		
iUL516	25		
iL9	26		

LED Line Voltage

Accent lighting	38	In-ground lighting	46
B1	38	i1.5	47
B4	38	i2.5	48
BT1	39	i3.5	49
BT5016	40	iT216	50
BU3	40	i3	51
MA3	41	SL-23	52
B3	41	SL-25	53
		SL-33	54
Flood lighting	42	SL-34	55
WAM1D	42	SL-43	56
WBM1D	42		
		Bollard lighting	58
Step and Aisle lighting	43	RD6	58
96 Line	43	RF6	58
RSF2	44	DB14	59
RSS2	44	DB21	59
RSC2	44	DB30	59
RSV2	44		
		Residential lighting	60
		Palermo	60
		Riviera	61
		Manor	62

LED index (alphabetically listed)

#		
96 Line	Line Voltage - Step and Aisle lighting	43
A		
AA11D	Low Voltage - Wall wash lighting	21
AL41	Low Voltage - Path and walkway lighting	28
AUL1D	Low Voltage - Wall wash lighting	21
B		
B1	Line Voltage - Accent lighting	38
B3	Line Voltage - Accent lighting	41
B4	Line Voltage - Accent lighting	38
BL16	Low Voltage - Accent lighting	20
BL5016	Low Voltage - Accent lighting	16
BL616	Low Voltage - Accent lighting	16
BL711	Low Voltage - Accent lighting	19
BL9	Low Voltage - Accent lighting	17
BT1	Line Voltage - Accent lighting	39
BT5016	Line Voltage - Accent lighting	40
BU3	Line Voltage - Accent lighting	40
BUL16	Low Voltage - Accent lighting	18
C		
CPL21	Low Voltage - Path and walkway lighting	29
CUL2D	Low Voltage - Path and walkway lighting	29
CUL7D	Low Voltage - Path and walkway lighting	30
CUL9D	Low Voltage - Path and walkway lighting	30
CUL10D	Low Voltage - Path and walkway lighting	31
CUL14D	Low Voltage - Path and walkway lighting	31
CUL16	Low Voltage - Accent lighting	19
D		
DAL1	Low Voltage - Deck lighting	27
DB14	Line Voltage - Bollard lighting	59
DB21	Line Voltage - Bollard lighting	59
DB30	Line Voltage - Bollard lighting	59
DCL1	Low Voltage - Deck lighting	27
DL1D	Low Voltage - Down lighting	23
DRL1	Low Voltage - Down lighting	23
DRL1D	Low Voltage - Down lighting	24
DRL2	Low Voltage - Down lighting	24
DUL1	Low Voltage - Deck lighting	27

I		
i1.5	Line Voltage - In-ground lighting	47
i2.5	Line Voltage - In-ground lighting	48
i3	Line Voltage - In-ground lighting	51
i3.5	Line Voltage - In-ground lighting	49
iL1116	Low Voltage - In-ground lighting	25
iL9	Low Voltage - In-ground lighting	26
iT216	Line Voltage - In-ground lighting	50
iUL516	Low Voltage - In-ground lighting	25
M		
MA3	Line Voltage - Accent lighting	41
MA5	Low Voltage - Accent lighting	18
Manor	Line Voltage - Residential lighting	62
MUL4	Low Voltage - Path and walkway lighting	33
P		
Palermo	Line Voltage - Residential lighting	60
R		
RD6	Line Voltage - Bollard lighting	58
RF6	Line Voltage - Bollard lighting	58
Riviera	Line Voltage - Residential lighting	61
RL4	Low Voltage - Path and walkway lighting	33
RL9	Low Voltage - Path and walkway lighting	33
RSC2	Line Voltage - Step and Aisle lighting	44
RSF2	Line Voltage - Step and Aisle lighting	44
RSS2	Line Voltage - Step and Aisle lighting	44
RSV2	Line Voltage - Step and Aisle lighting	44
S		
SL-23	Line Voltage - In-ground lighting	52
SL-25	Line Voltage - In-ground lighting	53
SL-33	Line Voltage - In-ground lighting	54
SL-34	Line Voltage - In-ground lighting	55
SL-43	Line Voltage - In-ground lighting	56
T		
TRL4	Low Voltage - Path and walkway lighting	33
W		
WAM1D	Line Voltage - Flood lighting	42
WAML1D	Low Voltage - Flood lighting	22
WBM1D	Line Voltage - Flood lighting	42
WBML1D	Low Voltage - Flood lighting	22



©2015 Koninklijke Philips N.V. All rights reserved. Philips reserves the right to make changes in specifications and/or to discontinue any product at any time without notice or obligation and will not be liable for any consequences resulting from the use of this publication.

PHc-1318BR 06/15 philips.com/luminaires

Philips Lighting
North America Corporation
200 Franklin Square Drive
Somerset, NJ 08873
Tel. 855-486-2216

Imported by: Philips Lighting,
A division of Philips Electronics Ltd.
281 Hillmount Rd,
Markham, ON, Canada L6C 2S3
Tel. 800-668-9008