

PHILIPS LIGHTOLIER

Downlighting

CorePro LED

Attractive, affordable, and easy to install 5" downlight



Project: _____
 Location: _____
 Cat.No: _____
 Type: _____
 Lamps: _____ Qty: _____
 Notes: _____

Core value LED downlight for new construction and remodel applications that installs in many existing residential and commercial applications.



Ordering guide

example: CP5RB07830W

Catalog Number	Aperture	CRI	CCT	Lumens	System Watts (Max)	Efficacy (lm/W)	Voltage
CP5RB08830W	5-inch	80	3000K	950lm	13	73	120
CP5RB08930W	5-inch	90	3000K	900lm	13	69	120
CP5RB08840W	5-inch	80	4000K	1000lm	13	77	120

Features

- Reflector/Flange:** One piece self flange cast aluminum, powder coated, non yellowing, white baffle and flange.
- Lens:** High transmittance lens allowing for smooth, diffused light pattern.
- Power supply:** Class 2 driver. Factory wired electronic LED driver (see Electrical section for specifications).
- LED board:** Light emitted source.
- Friction spring:** Stainless steel.
- Power connection:** Trim features quick connect plug installed as standard installation into CP5RN and CP5RR housings with mating connector. Trim ships with a medium base socket adapter whip for installation into 5" incandescent housings with medium base sockets.
- Lifetime:** Expected lifetime 50,000 hours and backed by a 5-year warranty (see Philips.com/warranties for details).

Electrical

Electronic power supply: RoHS compliant* Class 2 power unit for use in a dry and damp locations. Complies with FCC.

Dimming: All luminaires are intended for use with TRIAC type dimmers. Go to <http://www.lightolier.com/MKACatpdfs/LED-DIM>. PDF for the latest dimming switch capability information. 10%-100% dimming range.

Lumen Output	Input Voltage	Input Frequency	Max. Input Current	Max. Input Power	Max THD	Power Factor	Min. Temp. Operating
950lm	120V	50/60Hz	0.10A	13W	< 30%	> .9	-20° C

Performance data based on 80 CRI 3000K.

* Restrictions on Hazardous Substances (RoHS) is a European directive (2002/95/EC) designed to limit the content of 6 substances [lead, mercury, cadmium, hexavalent chromium, polybrominated biphenyls (PBB), and polybrominated diphenyl ethers (PBDE)] in electrical and electronic products. For products used in North America compliance to RoHS is voluntary and self-certified.

Labels

cULus listed for wet locations. Energy Star certified.

Title 24 Certified to meet high efficiency requirements.

CP5 CorePro LED Downlight

Attractive, affordable, and easy to install 5" downlight

CP5RN: 5" IC/Airseal frame-in kit housing

Housing - Constructed of formed aluminum. For use in direct contact with thermal insulation. Adjusts vertically in plaster frame to accommodate ceilings 1/2" to 1-1/2" thick. Ceiling opening 5-1/2".

Electrical Connection - LED quick-connect adapter

Junction Box- galvanized steel with two snap-on covers and grounding pigtail. Knockouts for 1/2" & 3/4" conduit and Romex knockouts with strain relief

Bar Hangers: Pre-installed pre-nailed style bar hangers telescope from 16" to 24". Vertical design of interlocking bar hangers prevents sagging even at full 24" extension. Style bar hangers may be used on either long or short axis of housing.

IC frame-in Kit - Housing is cULus Listed for direct contact with thermal insulation cULus Listed for Damp Locations and Through Branch Wiring, 4 in/4 out.

AirSeal™: Fixture is AirSeal™ rated according to ASTM E283 to no more than 2.0 cubic feet of air per minute at 75 pascals. Fixture meets Washington State Energy Code and Energy Conservation Code.

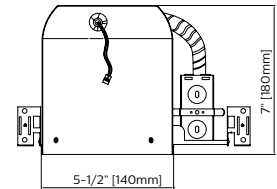
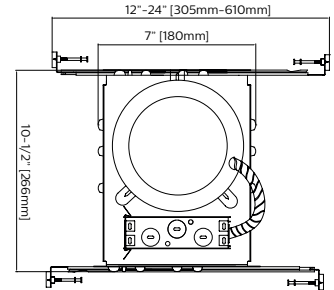

CP5RR: 5" IC/Airseal Remodeler Housing

Housing - Constructed of formed aluminum. Adjusts vertically in plaster frame to accommodate ceilings 1/2" to 1-1/4" thick. Housing can be pulled through plaster frame for access to junction box. Ceiling opening of 5-3/8".

Electrical Connection - LED quick-connect adapter

Junction Box - galvanized steel with two snap-on covers and grounding pigtail. Knockouts for 1/2" & 3/4" conduit and Romex knockouts with strain relief

IC Frame-in Kit - Housing is cULus Listed for direct contact with thermal insulation cULus Listed for Damp Locations and Through Branch Wiring, 4 in/4 out.

AirSeal™: Fixture is AirSeal™ rated according to ASTM E283 to no more than 2.0 cubic feet of air per minute at 75 pascals. Fixture meets Washington State Energy Code and Energy Conservation Code.

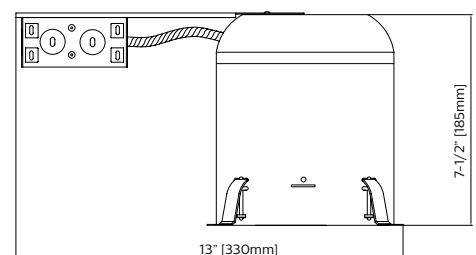
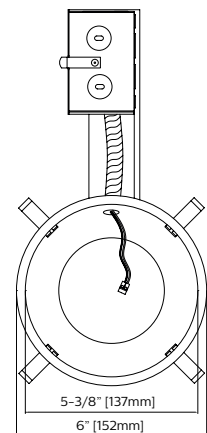

CP5 CorePro LED Downlight

Attractive, affordable, and easy to install 5" downlight

Dimensions

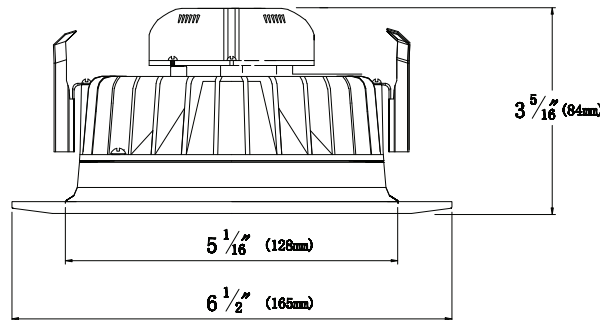

E26 Compatibility*

Manufacturer	Model
Philips	CP5RN CP5RR 1004IC 1004ICR CR5QP CRR5QP
Halo	H5ICAT H5RICAT H5T H5RT
Juno	IC20NW IC20N
Lithonia	L5 L5R

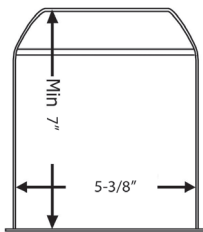

CP5RN: IC c/w LED Connector
New Construction Housing



CP5RR: IC c/w LED Connector
Remodeler Housing

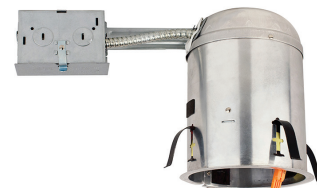

5" unit shown with standard (E26)
adapter to fit medium base sockets

* Any other luminaires meeting these dimensions as shown are also compatible.

CP5 CorePro LED Downlight

Attractive, affordable, and easy to install 5" downlight

CP5RB08830W

Candela Curves

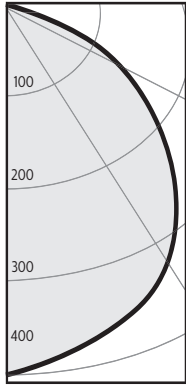

Angle	Mean CP	Lumens
0	402	
5	398	38
10	390	
15	377	107
20	359	
25	338	158
30	314	
35	289	184
40	261	
45	232	183
50	199	
55	163	152
60	127	
65	91	96
70	56	
75	26	34
80	9	
85	3	5
90	0	

Single unit data

Height to Lighted Plane	Initial center beam foot-candles	Beam dia. (ft)*
5'	16	6.0
6'	11	7.2
7'	8	8.4
8'	6	9.6
9'	5	10.8

* Beam diameter is where foot-candles drop to 50% of maximum.

Multiple unit data - RCR 2

Spacing on center	Initial center beam foot-candles	Watts per sq.ft.
5'	39.6	0.55
6'	26.0	0.36
7'	18.5	0.26
8'	15.5	0.21
9'	12.4	0.17

38'x38'x10' Room, Workplane 2.5' above floor, 80/50/20% Reflectances

Coefficients of utilization

Ceiling	80%				70%		50%		30%		0%	
Wall	70	50	30	10	50	10	50	10	50	10	0	
RCR	Zonal cavity method - Effective floor reflectance = 20%											
Room Cavity Ratio	0	119	119	119	119	116	116	111	111	106	106	100
1	110	106	102	99	104	97	100	94	96	91	87	
2	101	94	87	82	92	81	88	79	85	78	74	
3	93	83	75	69	81	69	78	68	76	66	63	
4	85	74	66	59	73	59	70	58	68	57	55	
5	79	66	58	52	65	51	63	51	61	50	48	
6	73	60	51	45	59	45	57	45	56	44	42	
7	67	55	46	40	54	40	52	40	51	40	37	
8	63	50	42	36	49	36	48	36	47	36	33	
9	59	46	38	33	45	32	44	32	43	32	30	
10	55	42	35	30	42	30	41	29	40	29	27	

Zonal lumens & percentages

Zone	Lumens	%Luminaire
0-30	303	31.7%
0-40	486	50.9%
0-60	821	85.9%
0-90	956	100.0%

Adjustment factors

Color temperature (CCT)
4000K = 106%

Report!: BTS165313

Output lumens:	956.2lms	Efficacy:	77.1lm/w
Input Watts ² :	12.4W	CCT ³ :	3000K
Spacing Criterion:	1.2	CRI:	>80

CP5RB08930W

Candela Curves

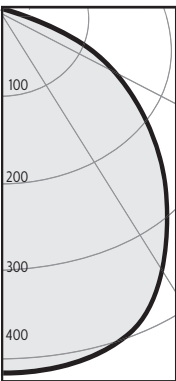

Angle	Mean CP	Lumens
0	407	
5	406	38
10	400	
15	389	108
20	372	
25	351	157
30	325	
35	295	177
40	263	
45	230	167
50	195	
55	157	128
60	120	
65	86	74
70	56	
75	30	26
80	13	
85	5	4
90	0	

Single unit data

Height to Lighted Plane	Initial center beam foot-candles	Beam dia. (ft)*
5'	16	5.5
6'	11	6.6
7'	8	7.7
8'	6	8.8
9'	5	9.9

* Beam diameter is where foot-candles drop to 50% of maximum.

Multiple unit data - RCR 2

Spacing on center	Initial center beam foot-candles	Watts per sq.ft.
5'	37.0	0.54
6'	24.3	0.35
7'	17.3	0.25
8'	14.4	0.21
9'	11.6	0.17

38'x38'x10' Room, Workplane 2.5' above floor, 80/50/20% Reflectances

Coefficients of utilization

Ceiling	80%				70%		50%		30%		0%	
Wall	70	50	30	10	50	10	50	10	50	10	0	
RCR	Zonal cavity method - Effective floor reflectance = 20%											
Room Cavity Ratio	0	119	119	119	119	116	116	111	111	106	106	100
1	111	106	103	100	104	98	100	95	96	92	87	
2	102	95	89	84	93	83	89	81	86	79	75	
3	94	84	77	71	83	71	80	69	77	68	65	
4	86	75	67	61	74	61	72	60	69	59	57	
5	80	68	60	54	67	53	65	53	63	52	50	
6	74	62	53	47	61	47	59	47	57	46	44	
7	69	56	48	42	55	42	54	42	53	42	39	
8	64	52	44	38	51	38	50	38	48	37	35	
9	60	47	40	34	47	34	46	34	45	34	32	
10	57	44	36	31	43	31	42	31	42	31	29	

Zonal lumens & percentages

Zone	Lumens	%Luminaire
0-30	303	34.5%
0-40	480	54.6%
0-60	775	88.2%
0-90	879	100.0%

Report!: BTS165314

Output lumens:	879.3 lms	Efficacy:	72.1lm/w
Input Watts ² :	12.2W	CCT ³ :	3000K
Spacing Criterion:	1.1	CRI:	>90

1. Correlated Color Temperature within specs as defined in ANSI_NEMA_ANSI C78.377-2008: Specifications for the Chromaticity of Solid State Lighting Products.

2. Wattage: controlled to within 5%

3. Tested using absolute photometry as specified in LM79: IESNA Approved Method for the Electrical and Photometric Measurements of Solid-State Lighting Products.

© 2016 Philips Lighting Holding B.V. All rights reserved. Philips reserves the right to make changes in specifications and/or to discontinue any product at any time without notice or obligation and will not be liable for any consequences resulting from the use of this publication. philips.com/luminaires



Philips Lighting North America Corporation
200 Franklin Square Drive, Somerset, NJ 08873
Tel. 855-486-2216

Philips Lighting Canada Ltd.
281 Hillmount Rd, Markham, ON, Canada L6C 2S3
Tel. 800-668-9008