

**PHILIPS**

Sensors

Design-in Guide

EasySense



# Single, compact, **cost-effective** **fixture control**

Philips EasySense fixture-mount sensors  
for models SNS102 and SNS200

# Contents

Introduction to this guide	3
More information or support	3
Warnings and instructions	3
Introduction of EasySense	4
Product characteristics	5
EasySense overview	5
NFC antenna	5
RF antenna	5
Infared (IR) receiver	5
Motion detector	6
Sensor view shield	6
Light sensor	7
LED indicator	8
System startup behavior/auto-calibration	9
System startup behavior	9
Auto-calibration routine	9
Lighting control	10
Terminology used in this chapter	10
Daylight harvesting	12
Occupancy sensing	13
Manual dimming override	16
Group occupancy sharing (SNS200 and future generations)	17
Scene setting (SNS200 and future generations)	23
Phone-based app and configuration	25
Mechanical design-in	26
Mounting to a luminaire	26
Wiring diagram with Philips Advance Xitanium SR LED driver	27
Sensor position	29
EasySense with multiple Philips Advance Xitanium SR LED drivers 1:N application	30
FAQ	31
Contact details	33
FCC/IC compliance statement	34
Disclaimer	35

# Introduction to this guide

Thank you for choosing the Philips EasySense sensor. In this guide fixture manufacturers will find the information required to design this product into a luminaire and configure it to suit specific applications. This design-in guide covers sensor functionality, mechanical mounting, wiring details, configuration and commissioning (grouping) method, application notes and frequently asked questions. For sensor specifications, please see the datasheet available at [www.philips.com/easysense](http://www.philips.com/easysense).

## **More information or support**

For further information or support, please consult your local Philips sales representative or visit [www.philips.com/easysense](http://www.philips.com/easysense).

# Warnings and instructions

- EasySense must be used only with Philips Advance Xitanium SR LED driver.
- Do not apply mains power directly to the sensor.
- Do not cover the sensor during operation or mount the sensor recessed.
- External infrared light source in the space might have influence on occupancy detection.
- Incorrect location of sensor (e.g., outside the view angle of the occupancy sensor) will result in occupancy detection not functioning correctly.
- When recalibration is needed for adapting to environment changes, make sure the Philips Advance Xitanium SR driver is power cycled. See System startup behaviors/ Auto-calibration section for details.
- Faulty settings of the sensor might result in undefined startup behavior; make sure field task level is set higher than the background light level.
- Make sure the sensor, especially the occupancy detection lens, is protected from damage during shipment and handling.
- The application area of EasySense is designed for a typical indoor environment (open/private offices, conference rooms, classrooms, corridors, etc.) in normally heated and ventilated areas. EasySense has no protection against aggressive chemicals or water.
- Make sure the the EasySense RF antenna is not covered by metal for proper RF communication.

# Introduction of EasySense

The Philips EasySense fixture-mount sensor is the ideal solution for per-fixture control of new light fixtures. It combines occupancy sensing, daylight harvesting and task tuning in a single, compact package for easy OEM fixture assembly. EasySense operates with the established Philips Advance Xitanium SR LED driver standard to make a simple two-wire connection between sensor and driver, thus eliminating the need for multiple components and auxiliary devices. The result is a cost-effective and easy-to-design-in solution ideal for energy-savings and code-compliance strategies. An intuitive app makes configuration and commissioning during and after installation fast and easy using Philips field apps.

SNS102 with basic grouping functionality enables addition of qualified wireless switches. Up to 40 sensors can be grouped to a switch using Philips field apps. In addition to easily adding user control to a space, the grouping feature facilitates auto-off/manual-on and auto-off/partial-on use cases.

SNS200 with advanced grouping functionality enables the addition of qualified wireless switches. Advanced grouping allows scene setting (e.g., presentation mode for a conference room), as well as occupancy sharing (i.e., fixtures within a group can be programmed to remain at prescribed light levels so long as occupancy is detected anywhere in the group).

# Product characteristics

## EasySense overview

The Philips EasySense contains multiple functions in one housing and uses two wires to connect with an SR driver. (See wiring diagram in the Mechanical design-in section.)

Functions include:

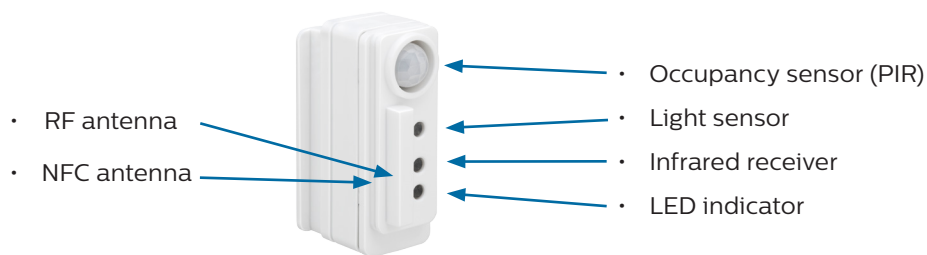

EasySense is designed for a typical indoor environment (open/private offices, conference rooms, classrooms, corridors, etc.) in normally heated and ventilated areas. EasySense has no protection against aggressive chemicals or water. The sensor is normally mounted to a luminaire and is optimized for a sensor mounting height of 8ft to 10ft (2.5m to 3m).

## NFC antenna

The EasySense sensor can be configured through NFC (near field communication) using a smart phone with the EasySense NFC app. NFC is the set of protocols that enables electronic devices to establish radio communication with each other by touching the devices together or bringing them into proximity to a distance of typically 0.4"/1cm or less. Parameters for lighting controls can all be configured. (See the Lighting control section.)

## RF antenna

The RF antenna allows communication via RF technology. It should not be covered by metal and should be exposed to free air to ensure there is sufficient range.

## Infrared (IR) receiver

The infrared receiver serves as a communication portal for the commissioning tools. EasySense with grouping functionality is enabled and commissioned (grouping) by a smart phone with the EasySense IR app.

## Motion detector

The occupancy sensor is a PIR (Passive Infrared) sensor that detects movement with an X-Y cross-area under an angle of  $X = 72^\circ$  and  $Y = 86^\circ$ . Two types of movements are defined in NEMA WD7 as follows:

Major movement: movement of a person walking into or through an area.

Minor movement: movement of a person sitting at an office desk reaching for a telephone, turning the pages in a book, opening a file folder, picking up a coffee cup, etc.

When installed in a typical office ceiling at H, the sensor is sensitive to minor movements within  $X1$  by  $Y1$  area. It will respond to minor movements down to a few centimeters at the task area of a desk and is sensitive to major movements within a range of  $X2$  by  $Y2$ . The maximum recommended height to place the sensor in the ceiling is 10ft/3m to assure movement coverage and detection. The PIR sensor reacts on movement by means of a temperature difference, such as the human body temperature versus its surrounding temperature. A car that just starts its engine is not seen by the PIR nor does the PIR see people sitting within the car or a forklift truck. Therefore, it is recommended not to use EasySense in outdoor, parking or industrial applications. Please refer to the EasySense datasheet for coverage area details.

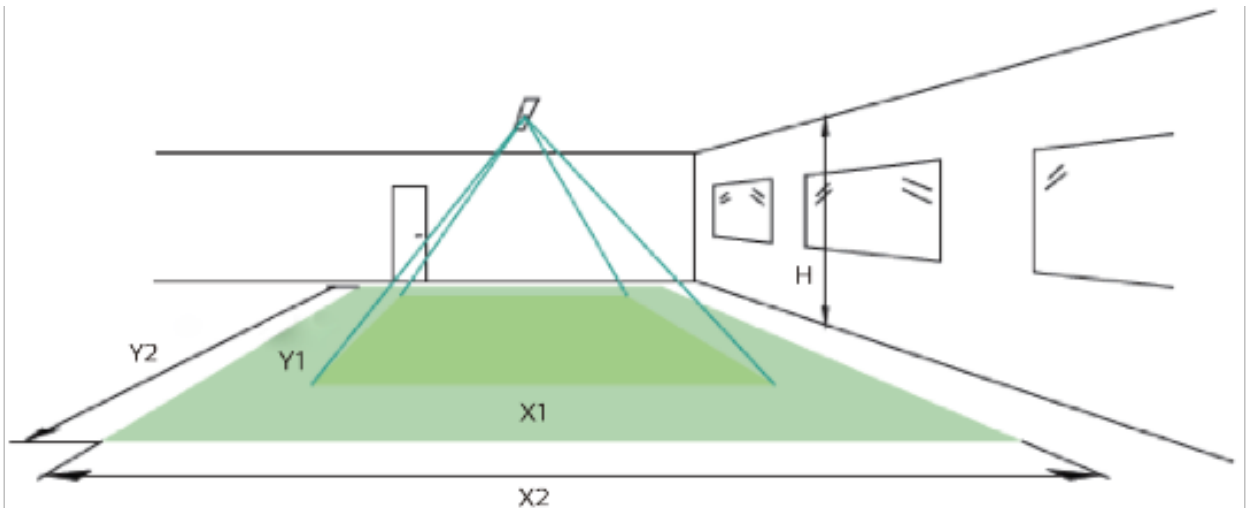

Figure 1. Motion detection area. H: ceiling height. Minor movement detection area:  $X1$  by  $Y1$ . Major movement detection area:  $X2$  by  $Y2$ .

## Sensor view shield

The sensor comes with an occupancy view shield that can be used to block the movement detection by the sensor in a certain area. The shield comes inverted. (See Figure 2.) This view shield can be pulled out, flipped and inserted back in the sensor and then rotated so the correct area is shielded off from the detection area. If such shield is not needed in the application, it can be easily pulled out from the sensor or left inverted.

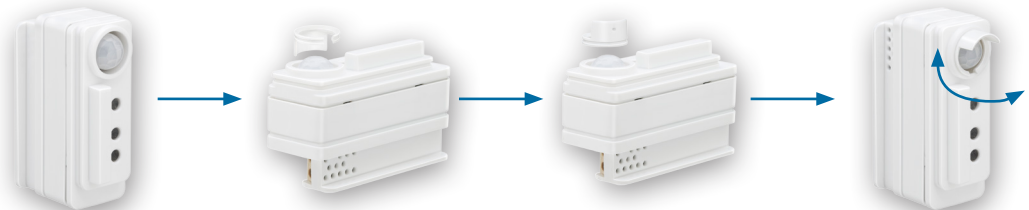

Figure 2. Sensor view shield.

## Light sensor

The light sensor is a photo diode that reads average light level captured under an angle of approximately 40°. The intensity of the illuminance depends on the amount of artificial and/or natural light supplied in the office, as well as how this light is reflected toward the ceiling/sensor. The EasySense converts the illuminance signal into ON/OFF or dimming commands to the Philips Advance Xitanium SR LED driver in order to maintain a constant light level on the desk.

The sensor should be installed with a minimum distance of 0.6m/2ft to the window to avoid the sensor looking outside. When the sensor is mounted too close to the window it will look partly outside. Sun reflection from cars or snow can reflect directly into the sensor. The sensor will then measure such high illumination levels that it will drive the artificial light to its minimal level or even switch off the artificial lights. The optimum distance [Y] from the window to EasySense can be obtained from Figure 4. This graph shows the relation between the distance from the window to the sensor [Y] and the height [H] of the sensor (H, height of the sensor measured from ceiling to bottom of window sill).

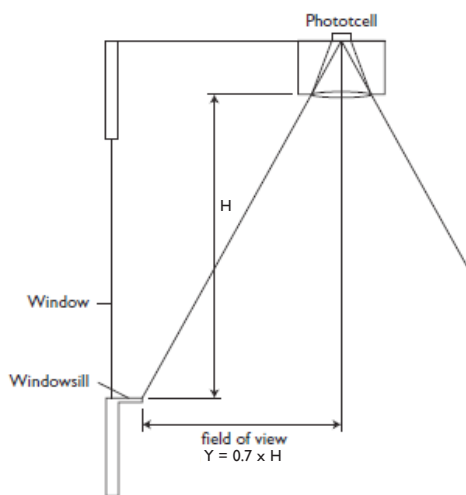

Figure 3. Sensor placement.

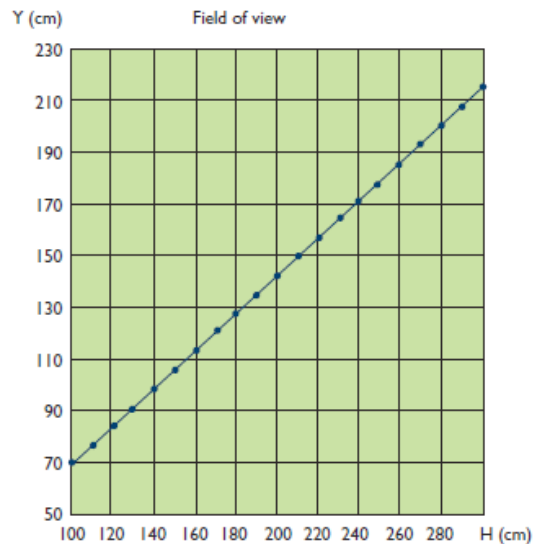

Figure 4. Sensor mounting height from window sill (Y) vs. sensor horizontal distance from window sill (H).

## LED indicator

The product contains an LED indicator to help comply with California Title 20 requirements. The LED indicator is enabled by default, and it can be disabled through the app. The behavior of the LED is as follows:

Yellow LED on: = vacancy & light sensor are functional.

Red LED on: = motion is detected and hold time is not expired yet.



# System startup behavior and auto-calibration

## System startup behavior

When the sensor is powered (mains of driver is switched on or a momentary power dip is detected by the sensor), the sensor performs an auto-calibration routine.

## Auto-calibration routine

Below describes the calibration routine.

- Light is switched on at maximum light level set by max of AOC (adjustable output current of the driver).
- Light dims down to minimum dimming level.
- Sensor stores the value detected by the light sensor.
- Light dims up to maximum light level, which is set by the field task level.
- Sensor stores the value detected by the light sensor.
- A calculation is executed, and calibration set point will be determined.
- Light dims down to the task level that meets the set point.



### Warning

Make sure no objects are blocking the sensor's view and no surface reflectance changes occur in the sensor's view during auto-calibration.

# Lighting control

The Philips EasySense enables stand-alone LED lighting systems with integrated occupancy sensing and daylight harvesting. Grouping control is activated through the Philips field app (Easysense IR) and adding wireless switches to the group. In addition to easily adding user control to a space, the grouping feature facilitates auto-off/manual-on and auto-off/partial-on use cases. Furthermore, advanced grouping allows scene setting (e.g., presentation mode for a conference room), as well as occupancy sharing (i.e., fixtures within a group can be programmed to remain at prescribed light levels so long as occupancy is detected anywhere in the group).

## Terminology used in this chapter

All parameters are stored in the sensor, and most of the parameters can be configured through NFC or IR.

- Fade to switch-on/off time
- Hold time
- Grace fading time
- Prolong time
- Field task level
- Background level
- Occupancy mode selection
- Eco-on level
- Group occupancy sharing (SNS200 or higher)
- Group light behavior (SNS200 or higher)

**Fade to switch-on time** is the time (T1 to T2) from the point at which occupancy is detected until the lights dim up to the max light output. This timer is set to 0.7 sec and is not configurable.

**Hold time** is the time (T3 to T4) from the point at which the last movement has been detected (e.g., occupant left the room) until grace time starts. This timer is set to 15 minutes by default and can be configured from 1 – 120 minutes.

**Grace fading time** is the time from T4 to T5 during which the lights are being dimmed down from the current light level to the background level. By default, grace fading time is 10 sec and can be configured to 0 – 25 seconds.

**Prolong time** is the time from T5 to T6 at which the background level is maintained at a fixed level. Default prolong time is 15 minutes and can be configured from 0 – infinity.

**Fade to switch-off time** is the time (T6 to T7) for the lights to fade from background level to off after prolong time is expired. This timer is set to 0.7 sec and is not configurable.

**Field task level** is used to configure the required light level on the task plane. Setting this to 100% enables the installed maximum light level. A lower percentage level can be configured to set the new maximum light level of the luminaire through the app. (See Task tuning.)

**Eco-on level** is a configurable switch-on light level. This parameter also enables partial-on occupancy based control to meet energy code. Eco-on level should be a percentage level between the field task level and background light level.

**Background level** is a light level significantly lower than 100%, used to save energy when space is not occupied.

**Occupancy mode selection** can be configured to meet energy code and maximize control flexibility with adding wireless switches. The mode options are auto-on/auto-off, manual-on/manual-off and manual-on/auto-off.

**Group occupancy sharing** is a configurable feature to allow EasySense to share its local occupancy detection status and control lights accordingly. As long as presence is detected within the group, the luminaires stay on at the background light level/field task light level (configurable) in non-occupied areas.

Group light behavior is a configurable light level for the luminaires in non-occupied areas while there is occupancy detected elsewhere in the group.

### Occupancy-based lighting control

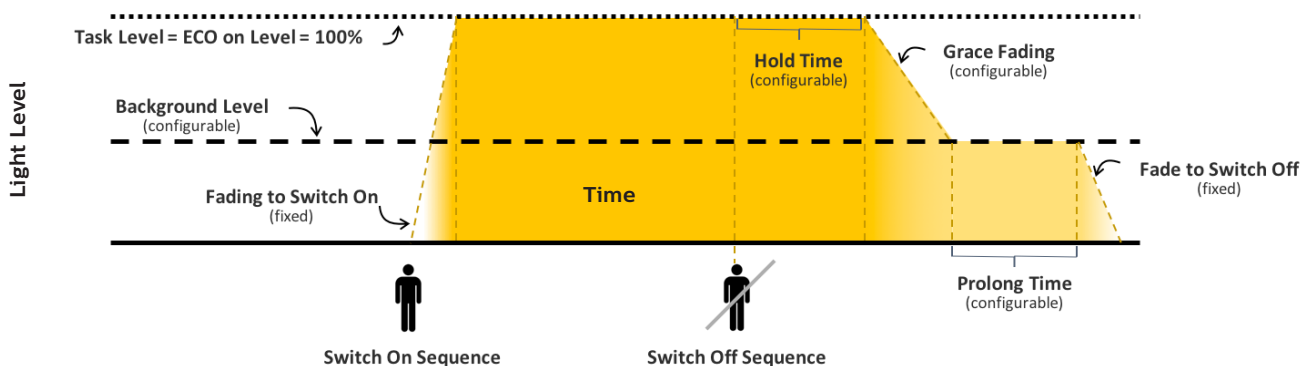

Figure 5. Occupancy-based lighting control switching sequence.

Auto-on/off mode: Lights are switched on and off automatically based on occupancy detection and time delay settings.

Manual-on/auto-off: Lights are turned on manually through a wireless switch and turned off automatically, as a vacancy sensor.

Manual-on/off: Lights are turned on and off manually through a wireless switch while occupied.

### Task tuning

Field task tuning is a feature to reduce the maximum output of a fixture to a certain percentage of the AOC (adjustable output current) of the driver. After installation, there is a possibility that the task light level is not set according to the end user needs (light level too high). Task light level can be adjusted by the installer or building maintenance personnel to a value between 5% and 100% of the max setting through the app.

## Daylight harvesting

Daylight-based control is enabled by default. The light sensor auto-calibrates when power to the driver is cycled. The light level of the luminaire is bound by field task level (maximum light level) and background level (minimum light level). If the background light level is set to be 20%, during daylight harvesting, the light will only dim to 20%.

Daylight-based control is not active after hold time of the occupancy sensor expires. Figures 6 and 7 show examples of lighting control using both daylight and occupancy. In both figures, eco-on level = field task level. If eco-on level is lower, then the maximum light level will be the eco-on level. When the daylight level is low (Figure 6) and an occupant is present, the luminaire light level is the field task level minus the daylight level. Assuming the incoming daylight level is constant, luminaire light level remains the same until hold time expires, then it will fall to the background light level. When the daylight level is high, the luminaire light level is the field task level minus the daylight level. However, when there is an abundance of daylight, the luminaire light level does not dim lower than the background light level (Figure 7).

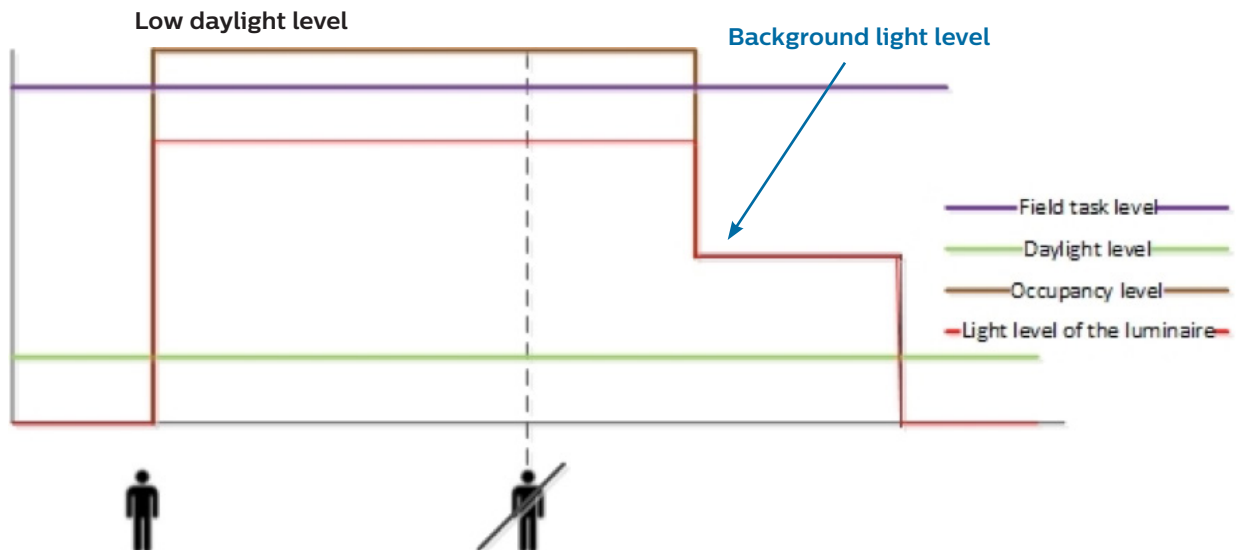

Figure 6. Lighting control behavior with low daylight level.

Light level of the luminaire = field task level - daylight level

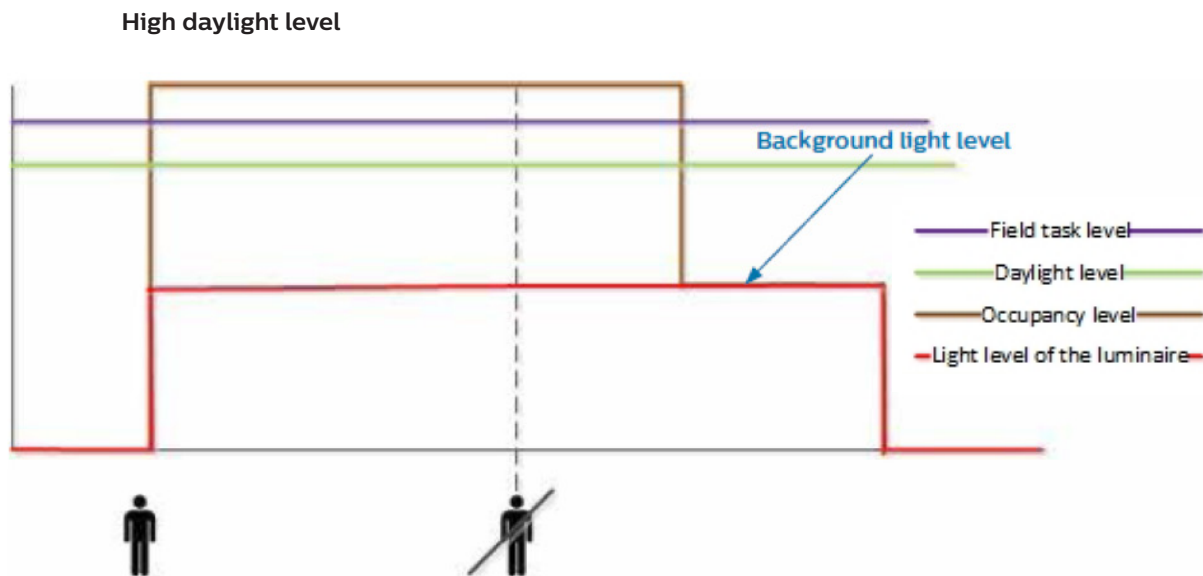

Figure 7. Lighting control behavior with high daylight level.

## Occupancy sensing

### Switch-on/off sequence

If occupancy is detected, lights are dimmed up to the eco-on light level in 0.7 second. When occupancy is not detected anymore, the following lighting switch-off sequence is executed: the sensor will wait until the hold time is expired and then the light fades the background level in grace fading time. The light level is kept at the background level for prolong time. After prolong time expires, the light fades from the background level to off in 0.7 second.

Occupancy-based lighting control is enabled by default for the EasySense, and it can be disabled using an app through NFC or IR.

### Use case

Max rating of the luminaire: 4000lm

The user configures the sensor parameters through Philips field apps:

Task tuning level = 80% = 3200lm

Eco-on level = 70% = 2800lm

Background light level = 20% = 800lm

Min dimming level of driver = 5% = 200lm

Note: All percentage levels refers to the max rating of the luminaire.

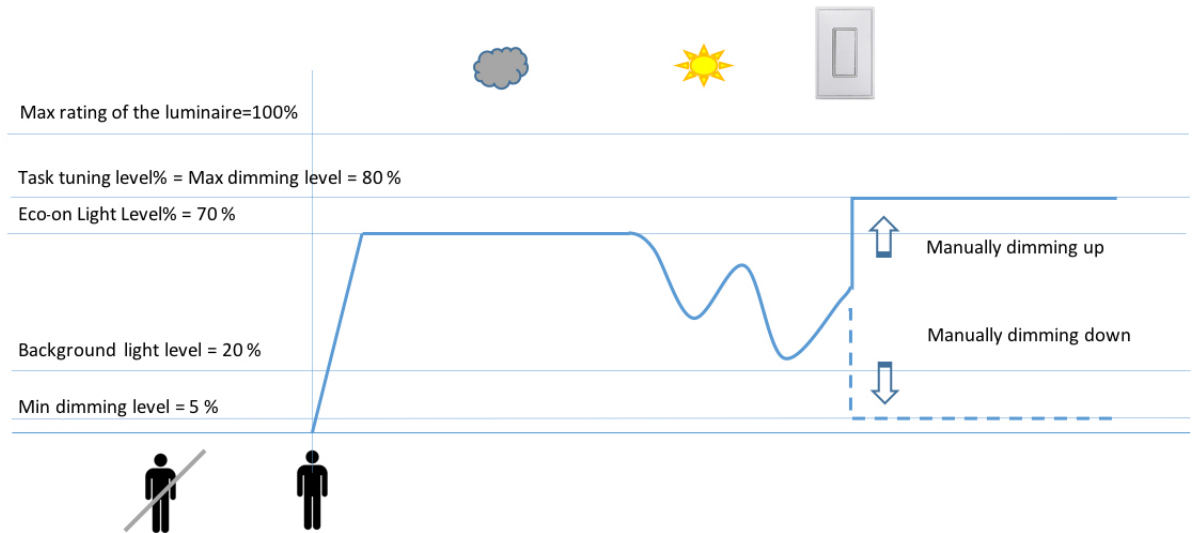

Figure 8. Automatic lighting control with manual dimming override.

The full dimming range of the luminaire is bounded by task tuning and min dimming level. By setting field task tuning = 80% and with driver minimum dimming level = 5%, the luminaire light output range is 3200lm to 200lm. The automatic lighting control range is 2800lm to 800lm by setting the eco-on level to 70% and background light level to 20%. However the wireless switch can be used to control the full dimming range of the light (3200lm ~ 200lm).

### Partial-on and partial-off occupant sensing

EasySense sensor offers both partial-on and partial-off occupancy control strategy to meet Title 24 use case through setting a few parameters.

Two means of realizing partial-on occupancy sensing:

- Under auto-on/auto-off mode: eco-on level (100% by default) can be set less than 100% to automatically switch on the lights partially. It is recommended to set between 50% and 70% to meet Title 24.
- Under manual-on mode, the light goes to the eco-on level when the switch is pressed.

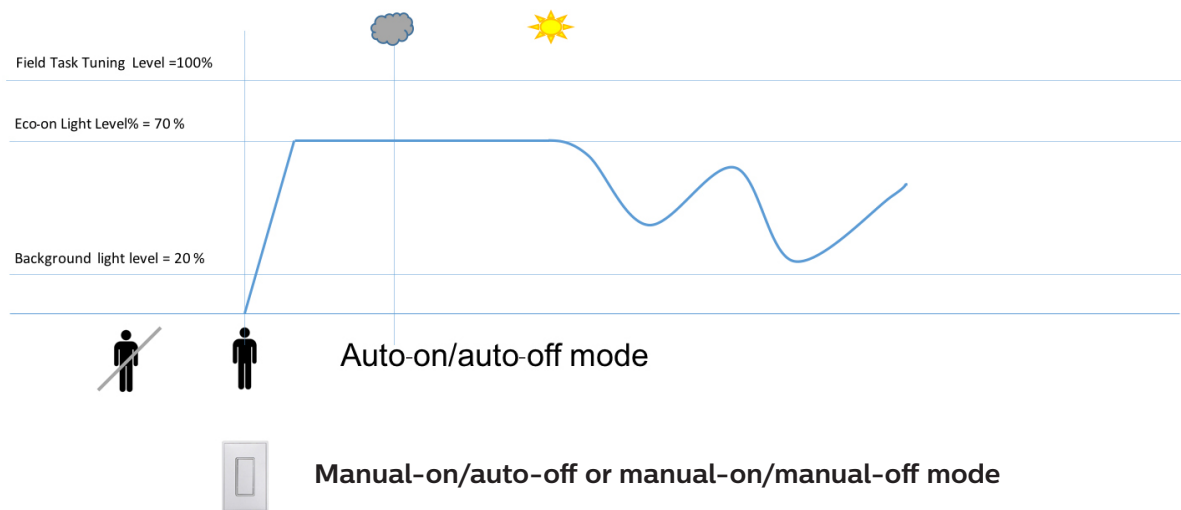

Figure 9. Partial-on with auto mode or manual mode.

Partial-off occupancy sensing can be achieved by configuring the prolong time to “infinity” and background light level less than 100% for applications like corridors and warehouse aisle ways.

## Manual dimming override

Light level can be tuned into any level between max (task tuning level) and min (minimum dimming level of the LED driver) by pressing the dimming up and dimming down button of the switch.

- Light level can be set to an intermediate level by manual dimming override using the wireless switch. When a manual dimming override is performed, daylight-based control is disabled, and light will be on constantly at this level. When the room becomes unoccupied, the light goes to the background light level during prolong time, and if the occupant enters the room before prolong time expires (Figure 10), the light will stay at the level set by the manual dimming override. If the prolong time expires, the light will turn off and go to the eco-on level when occupant enters the room (Figure 11).

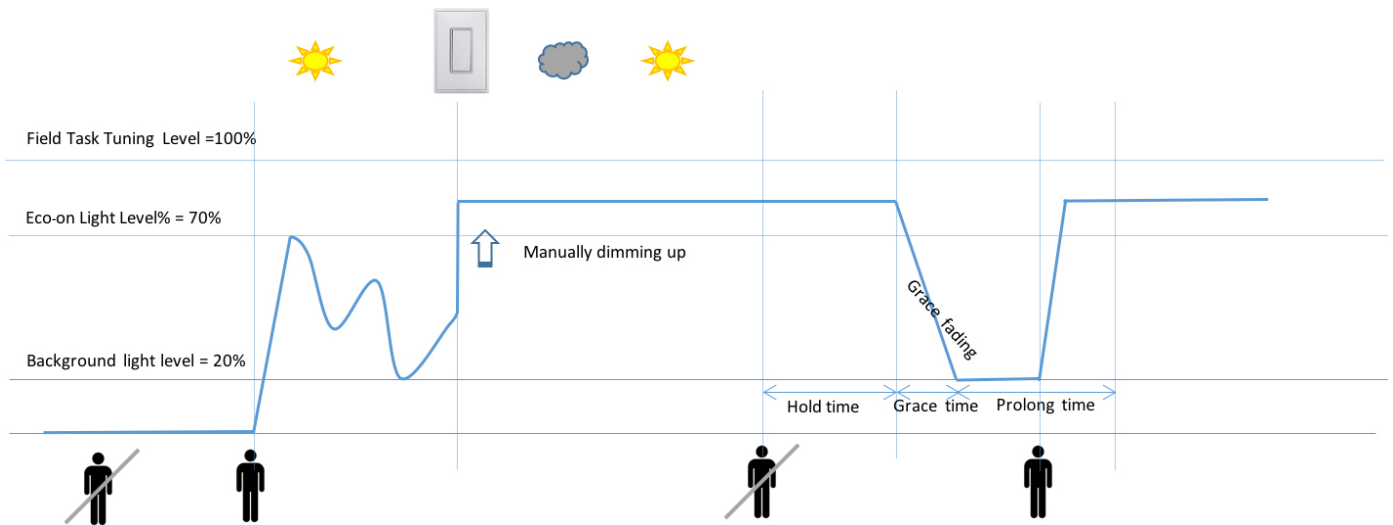

Figure 10. Auto-on/auto-off with manual dimming override.

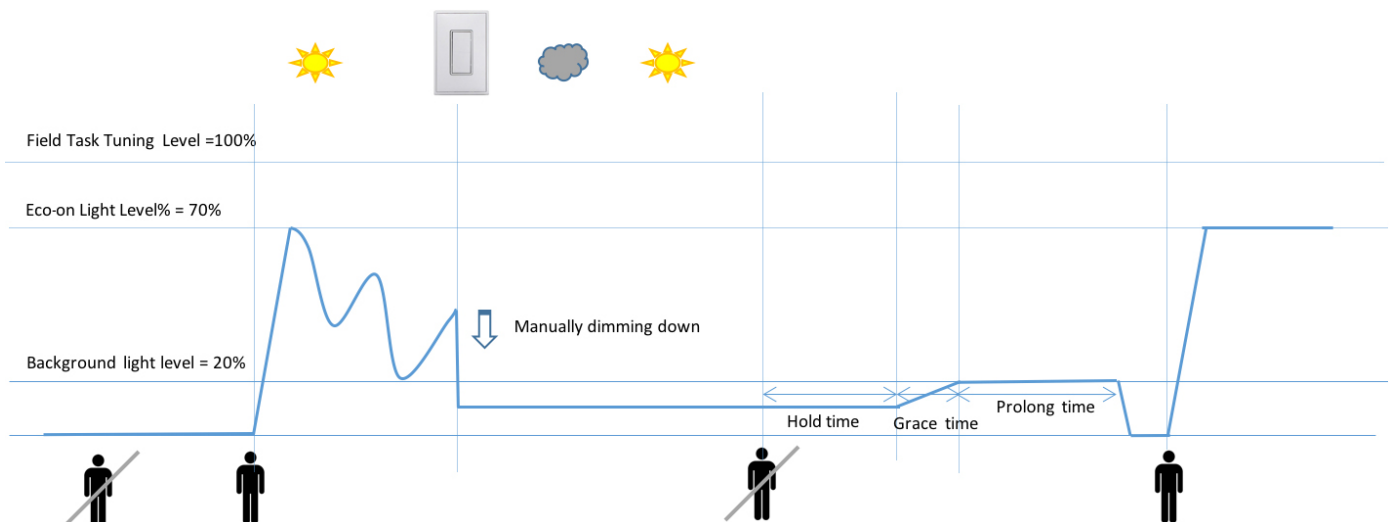

Figure 11. Auto-on/auto-off with manual dimming override.



## Group occupancy sharing (SNS200 and future generations)

Philips Easysense SNS200 includes a unique feature that enhances energy savings while maintaining aesthetics of the space. Through use of group occupancy sharing, luminaires provide full light output at occupied workstations and lower background light level at unoccupied workstations. The sensors in a defined group know if there is occupancy elsewhere in the group and will not turn off until the entire group is unoccupied.

The group occupancy sharing feature can be enabled (default)/disabled through the Philips field apps. The group lighting behavior can also be configured to background light level or task light level. With the group occupancy sharing disabled, the luminaire does not share its occupancy status with other luminaires or respond to the occupancy detection from the rest of the group. After installation, a group of up to 40 luminaires can be created easily and quickly using the Philips field apps.

Note: During the group occupancy sharing, daylight harvesting still occurs automatically if enabled.

Below is an example of the group occupancy sharing behavior in an open office application.

### An open office application



Figure 12. Open office application.

As people enter, lighting in their area dims up to "task level." Others in the group dim up to "background level."



Figure 13. Light adjusts as room occupancy changes.

As additional people enter, lights in their area dim up to "task level."



Figure 14. Lights dimming up.

As more workers enter, the lights dim up accordingly.

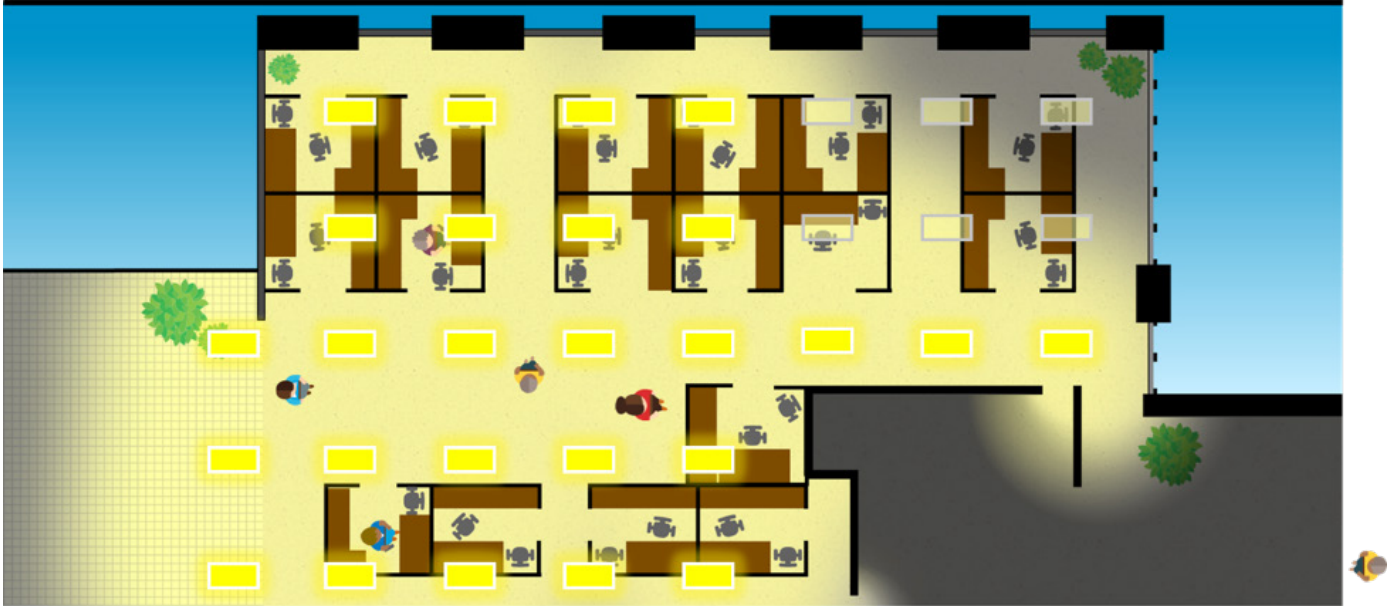

Figure 15. Lights dimming up.

When the space is fully occupied, all lights are on "task level."



Figure 16. Light at "task level."

As people go to lunch or meetings, lights gently dim down to a configured "background level."

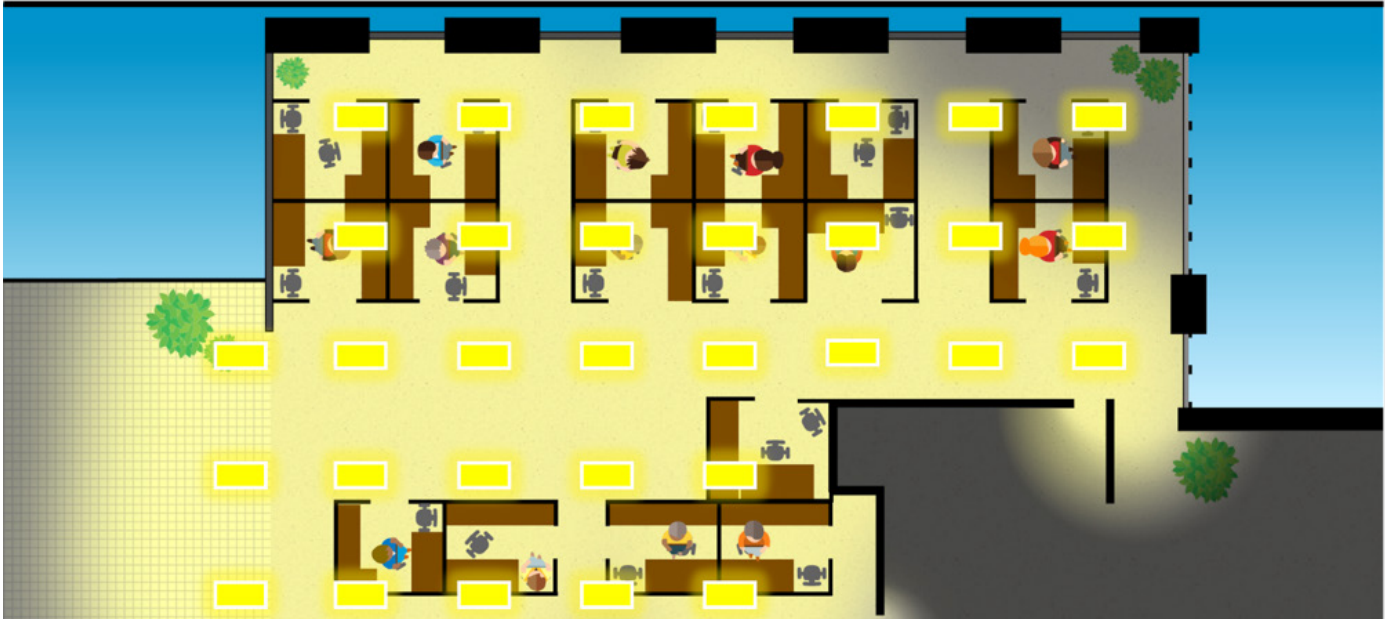

Figure 17. Light adjusts to "background level."

As people begin leaving for the day, additional lights dim down.

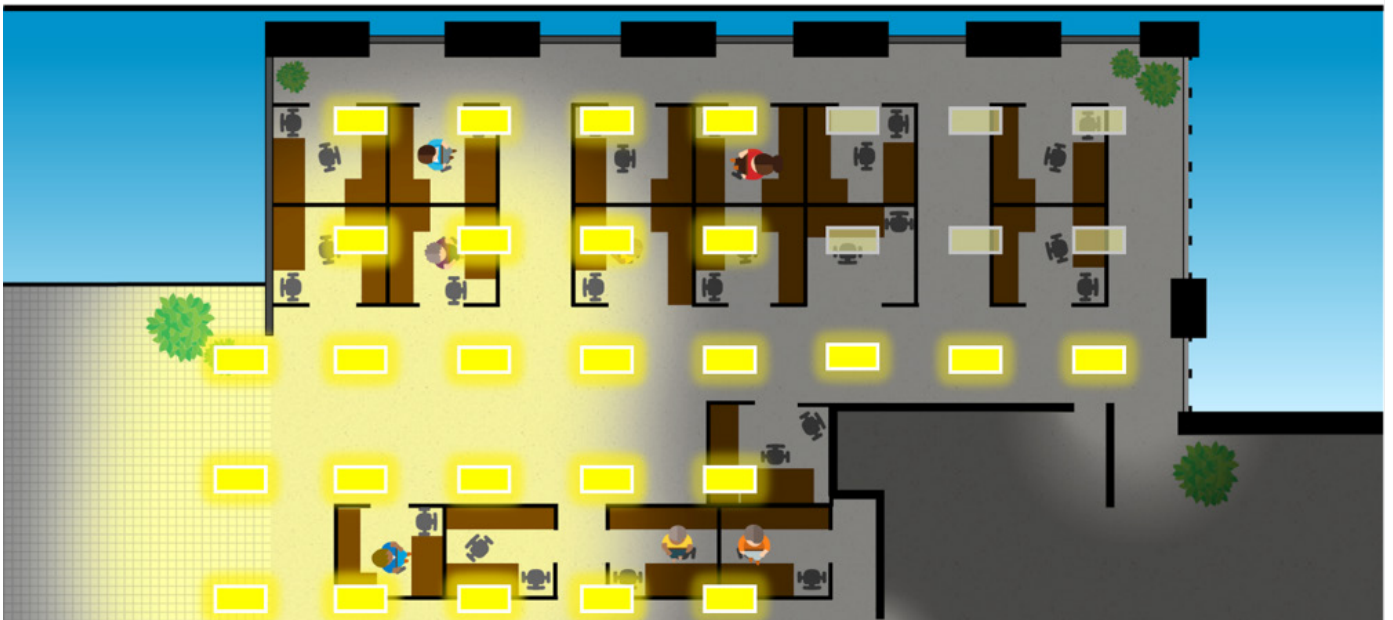

Figure 18. Additional light dims.

As the space empties, more lights dim down to to the background.



Figure 19. Light dims.

After the last worker leaves, lights turn off after a configured "prolong time."



Figure 20. Light turns off.

Lights turn off after a configured "prolong time."



Figure 21. Light turned off.

### Scene setting (SNS200 and future generations)

Light settings for meeting and conference rooms need to be flexible to fulfill a variety of situational requirements. For example, audiovisual presentations may require lower light levels near the screen versus a regular meeting requiring uniform lighting on the task level. EasySense together with wireless switches and the Philips field apps enables easy lighting configuration remotely for two scenes after the installation. (See app user manual for details to configure scenes.)

The wireless switch comes with four buttons.

Top left button: On/Dim-up

Bottom left button: Off/Dim-down

Top right button: Scene 1

Bottom right button: Scene 2

Once a scene button is pressed, the group of lights goes to the preset light level and does not respond to daylight variation any longer.

#### A conference room for presentations

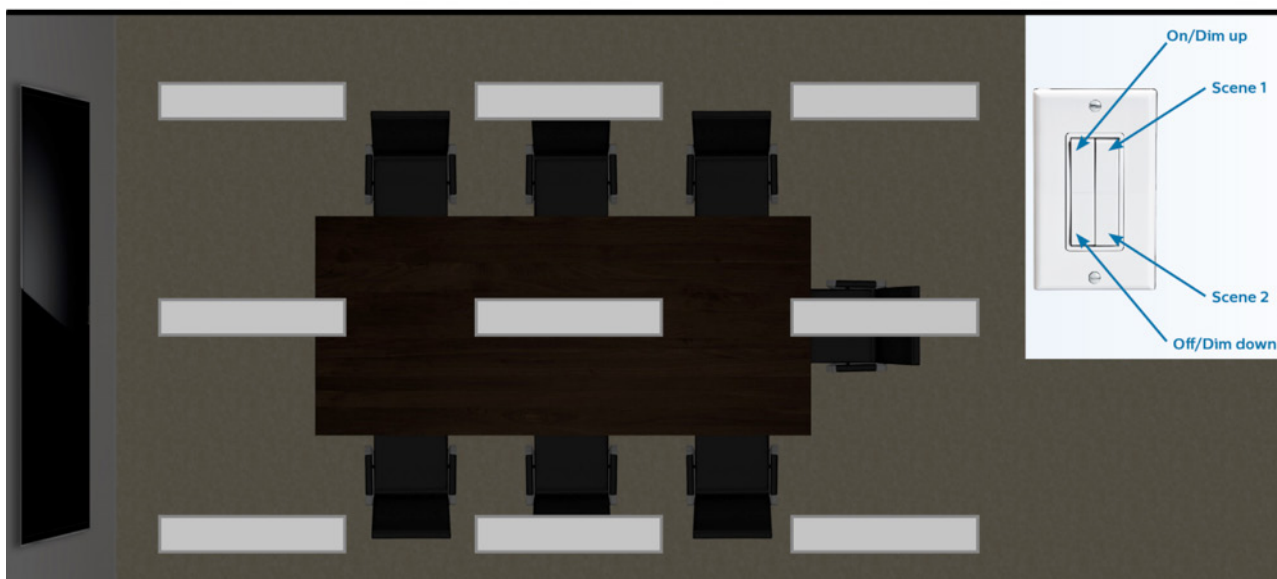

Figure 22. Conference room application.

Pressing "On" brings lights to "task level."

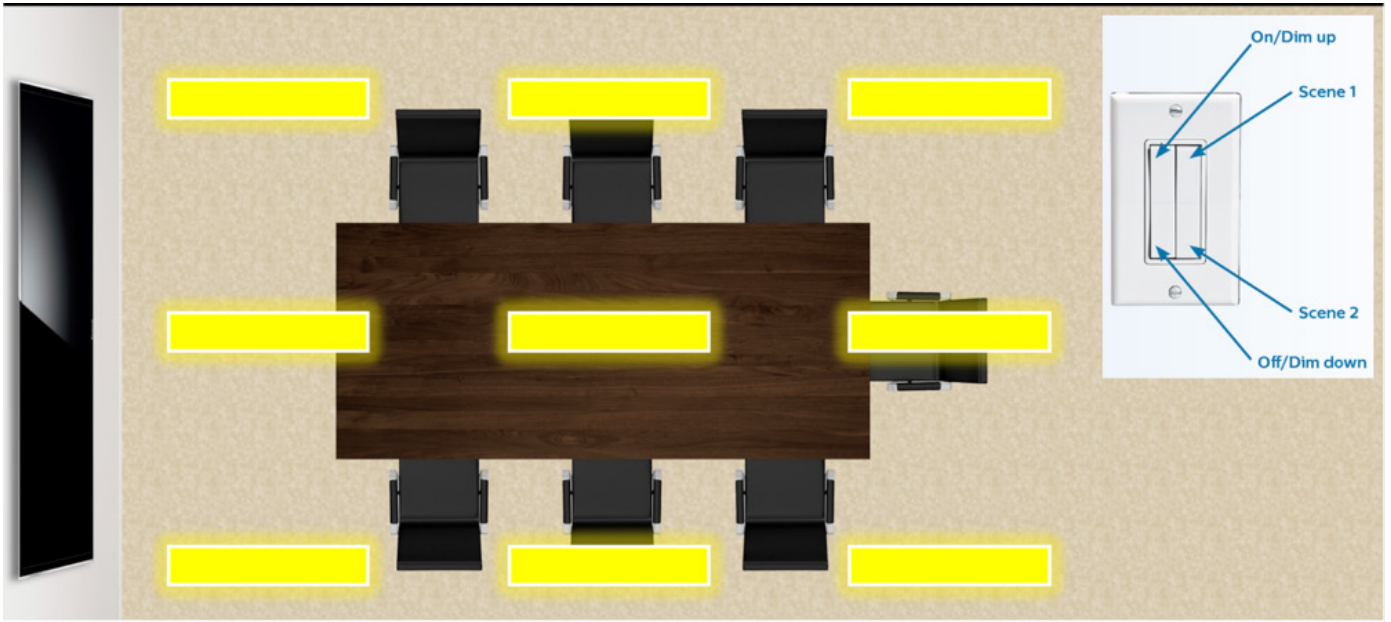

Figure 23. Conference room at "task level."

Pressing "Scene 1" takes lighting to pre-defined "presentation level."



Figure 24. Conference room at "presentation level."



# Phone-based app and configuration

There are two apps available for configuring and commissioning (grouping) EasySense with NFC and IR blaster functionality: Easysense NFC and EasySense IR. EasySense IR app can be used with EasySense SNS 102 and future generations.

Phone requirement: The EasySense app works only on Android-based smartphones. Check the [EasySense website](#) for the latest list of compatible phones and their NFC reader locations.

The app can be downloaded from the Google Play Store. This is a B2B app requires authentication with user ID and password. Please register at [www.philips.com/easysense](http://www.philips.com/easysense) to obtain user id and password.

Various sensor parameters can be configured through the app. Please check the latest user's manual at [www.philips.com/easysense](http://www.philips.com/easysense) for information on using the app with EasySense. The configuration range of each parameter is listed in the EasySense datasheet.

# Mechanical design-in

## Mounting to a luminaire

EasySense is a fixture-mount sensor that is directly powered by a Philips Advance Titanium SR LED driver. It can be mounted to a slot or a cut-out in sheet metal.



### 1. Mounting in a U-shaped slot in the fixture sheet metal

EasySense can be assembled into an open-ended slot with dimensions following the cut-out dimensions shown in the data sheet. Max sheet metal thickness is 1mm.



Note: in a precaution box, please make sure the the Easysense RF antenna is not covered by metal.

## 2. Mounting to rectangular cut-out

Another option is attaching EasySense to a cut-out in the sheet steel. An additional mounting ring (Part Number:SMR-50) is used to snap to the EasySense, essentially sandwiching the sheet steel between the ring and sensor. Thickness to accommodate this method is 0.7mm to 1mm.

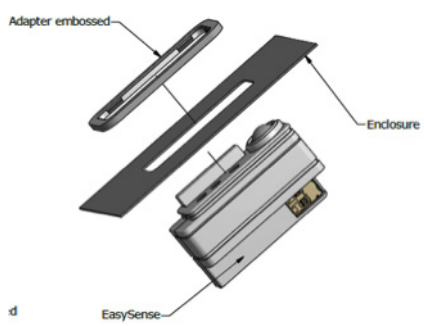

## 3. OEM-developed mounting options

OEMs can develop mounting provisions specific to their own fixtures and materials.

### Wiring diagram with Philips Advance Xitanium SR LED driver

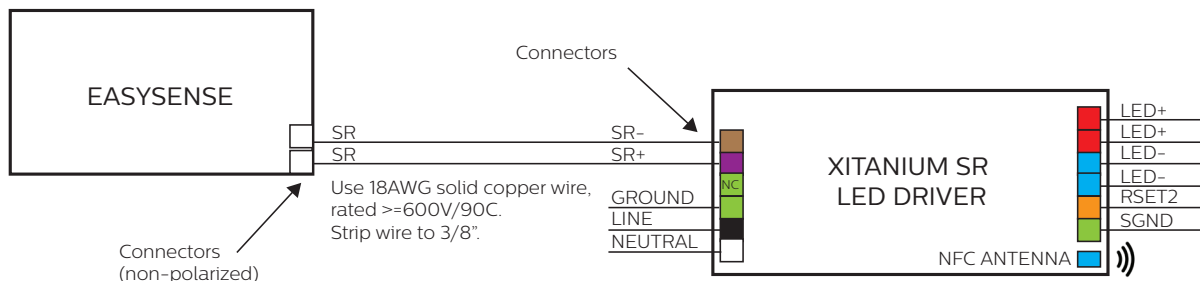

Figure 12. Wiring diagram with Philips Advance Xitanium SR driver.

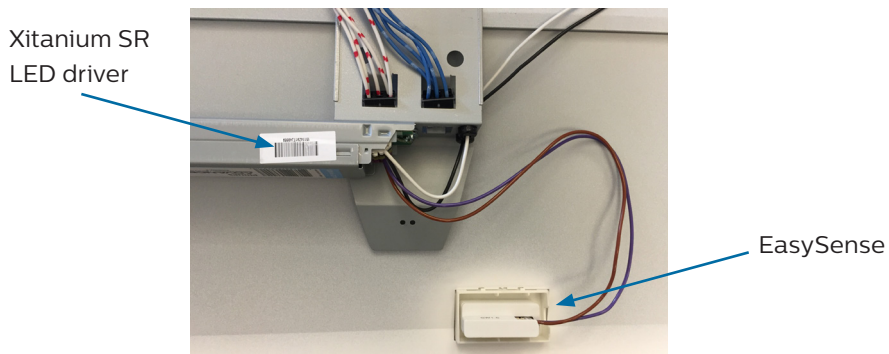

Figure 13. Sensor in a fixture.

## Applicable wires

Wire Range AWG#	Number of Conductors / Diameter of a Conductor (Number of Conductors / mm)	Insulation Diameter (mm)	Conductor Type
24	1 / 0.51 (0.2mm <sup>2</sup> )	1.35	Solid
22	1 / 0.64 (0.3mm <sup>2</sup> )	1.48	
20	1 / 0.81 (0.5mm <sup>2</sup> )	1.65	
18	1 / 1.02 (0.8mm <sup>2</sup> )	1.86	
22	17 / 0.76 (Reference) After Soldering: c0.9mm Max.	1.60	Strand
20	21 / 0.95 (Reference) After Soldering: c0.9mm Max.	1.78	

Table 1. Wire gauge for EasySense sensor with SR driver.

## Wire strip length



[Conductor : Bare Copper/Strand Wire]

## Wire insertion

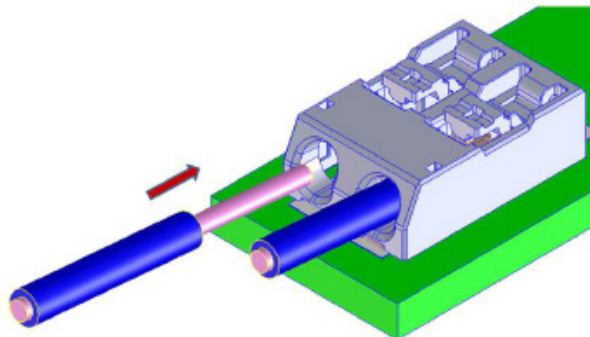
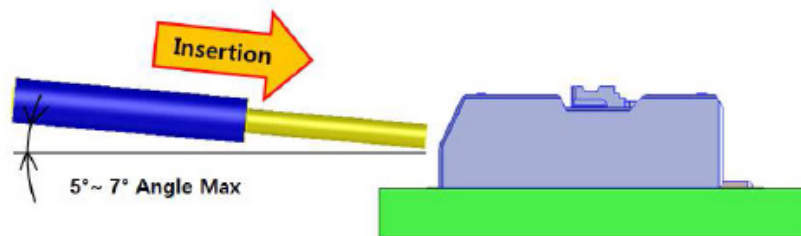

[ Inserting solid conductors via push-in terminal ]

### Wire separation from the connector

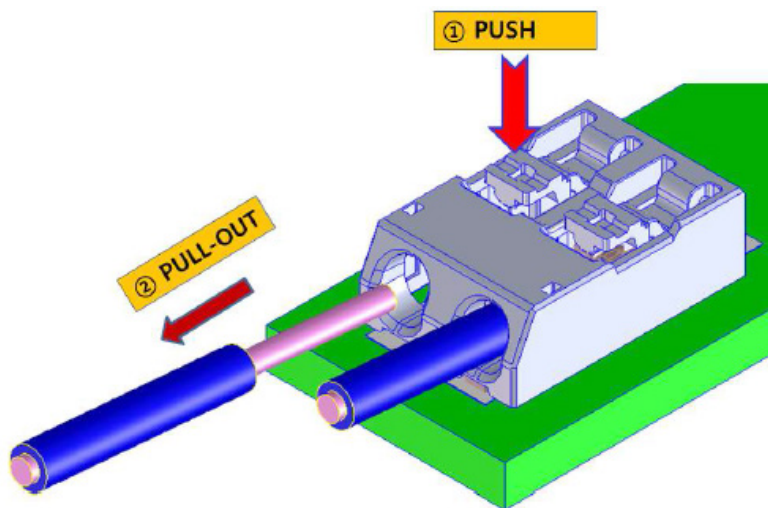

### Wire distance for remote mounting

It is recommended to keep the wire distance from sensor to Philips Advance Xitanium SR LED driver less than 50 feet and meet the wire gauge requirement to guarantee the performance.

### Sensor position

If multiple luminaires are used in the same area, the distance between the different sensors should be at least 1.5m. This distance will minimize a sensor from “seeing” the light variation of other luminaires and reacting.



Figure 25. Distance between sensors should be at least 1.5m apart.

# EasySense with multiple Philips Advance Xitanium SR LED drivers (1:N application)

When a group of luminaires is in the same daylight condition and needs to be operated at the same level, it is possible to use one sensor to control multiple luminaires. When EasySense is connected to multiple Philips Advance Xitanium SR LED drivers, the maximum number of connected drivers is 10 and only four drivers can have enabled DALI power supply. To minimize unnecessary losses, it is recommended to turn on only two DALI power supplies. Each SR driver provides approximately 55mA of current on the DALI bus, and EasySense is limited to 250mA.

EasySense sends commands to all connected drivers (using broadcast command); it does not have capabilities for addressing individual drivers. The light commands are sent as a broadcast command, so occupancy-/daylight-based lighting control and task tuning operate the same on all connected drivers. The readout of energy information from the driver will not function. The energy readout of multiple drivers is foreseen for future sensor generations.



Please note the DALI power supply can only be turned on/off on the Philips Advance Xitanium SR LED driver through MultiOne configurator. For this application, please also make sure all drivers that are connected to the sensor have the same wiring polarity. SR drivers are shipped with the power supply on as default.

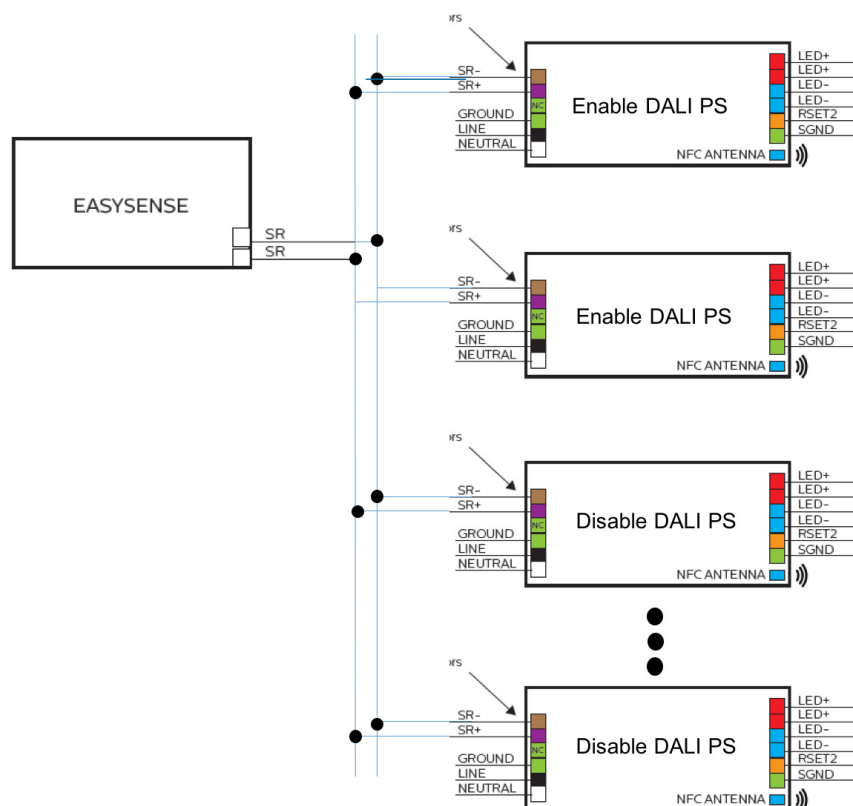

# FAQ

## **Does EasySense work on 0-10v drivers?**

No. EasySense works on Philips Advance Xitanium SR LED drivers to enable two-way digital communication directly to the driver and to eliminate need for other auxiliary devices.

## **Can you use a wall dimmer with EasySense?**

SNS102 and higher models can be used with a wireless wall dimmer, e.g., Zigbee green power switch.

## **How does EasySense compare to Philips ActiLume?**

Occupancy sensing and daylight harvesting are similar. Form factors are also similar, with the face of the sensor outside the fixture having the same size. The portion of EasySense within the fixture is slightly deeper and longer to accommodate added functionality. EasySense includes institutional tuning plus energy reporting and also works on Philips Advance Xitanium SR LED drivers to eliminate the cost and complexity of a separate power pack. EasySense also performs auto-calibration for daylight (see later Q&A).

## **Is EasySense a DALI sensor?**

EasySense works with Philips Advance SR LED drivers, which use DALI to communicate between driver and sensor. This is the same principle as other SR-certified devices, therefore, EasySense is not a DALI sensor.

## **Can I use EasySense outside a fixture?**

An accessory option is available to enable ceiling mount (part number SNS102CMP). Wiring to the driver must be managed similar to other external mounted sensors (code requirements, etc.). Because EasySense is low-voltage class 2, this is easier than with many other sensors.

## **Can I use one sensor with multiple fixtures?**

Yes, and the ceiling mount option is likely utilized in this use case (called 1:N operation as opposed to 1:1). It usually means turning off the SR power supplies in all but one of the SR drivers. See EasySense with multiple SR drivers 1:N application section.

## **Is EasySense “code compliant?”**

EasySense is self-certified as compliant with the requirements of California’s Title 20.

## **What about Title 24 and ASHRAE?**

These codes apply to the application of lighting and controls within a space, not individual components. They are very detailed, and lighting experts choose the proper lighting and control strategy to meet applicable codes. Use cases, interpretations and specific applications by state/local ordinance vary widely. EasySense is an economical component that can be used to meet many elements of code.

**Does EasySense do “auto-off/manual-on?” I hear it is required to meet codes.**

SNS102 supports auto-off/manual-on functionality via wireless switches. There are use cases in codes that are interpreted to require auto-off/manual-on. The auto-off/partial-on mode can be supported by eco-on.

**How do you handle use cases in codes calling for dimming?**

There are use cases in Title 24 that require “controls.” Continuous dimming via wall dimmer is one option to satisfy this requirement. Daylight, task tuning and manual dimming override are also other options to satisfy these use cases that are enabled via EasySense.

**Why only PIR? I thought dual-technology sensors were best?**

Dual-technology sensors include ultrasonic as well as infrared (PIR) technology. Use of ultrasonic developed out of the need to 1) discern small movements better and 2) “see” through partitions. Philips PIR technology has developed over recent years to handle small movements quite well. PIR does not transmit through walls/partitions, so sensors using ultrasound may have benefit when using a single sensor for large areas with blocking elements. EasySense targets bringing controls to a more granular level rather than only controlling a large space, such that PIR will see its designated space very well.

**Does EasySense make sense if I only want to do occupancy sensing?**

Yes. Most occupancy sensors run on high voltage or require an extra power pack, adding cost and complexity. Typical wallplate-style occupancy sensors — while mass produced and inexpensive — vary in performance by use case since the viewing angle from a wall is less than ideal. Also, the relay-free operation of EasySense makes it inherently more reliable. And traditional occupancy sensors are bulky compared to the compact size of EasySense.

**How does the daylight harvesting feature work?**

EasySense does auto-calibration (T20 requirement) when the fixture is first powered. See the system startup behavior/auto-calibration section for details. Electric lighting will not reduce below the programmed background light level regardless of daylight availability. Traditional sensors lacking auto-calibration are either pre-set with an assumed task light level or require manual calibration during commissioning.

**Is EasySense “failsafe”?**

Unlike traditional occupancy sensors, EasySense does not have a mechanical relay. This is a benefit of Philips Advance Xitanium SR LED drivers, as on/off is done relay-free within the driver. Devices with mechanical relays should be designed so that relay failure results in “lights on.” If an SR driver does not see a digital signal from a device for a long period of time (e.g., loose connection, sensor failure), the driver goes to full programmed output.



# Contact details

Philips EasySense

Product information:  
[www.philips.com/easysense](http://www.philips.com/easysense)

Or contact your local Philips sales representative.

# FCC/IC compliance statement

This device complies with part 15 of the FCC rules for the United States and Industry Canada (IC) license-exempt RSS standard(s). Operation is subject to the following two conditions: (1) This device may not cause harmful interference, and (2) this device must accept any interference received, including interference that may cause undesired operation. Any changes or modifications not expressly approved by Philips could void the user's authority to operate this equipment. This product is intended for commercial use only.

## **Déclaration de conformité à la fcc/ic**

Ce dispositif est conforme à la partie 15 des règles de la Federal Communications Commission (FCC) des États-Unis et d'Industrie Canada (IC) exempts de licence RSS norme(s). Son fonctionnement est assujéti aux deux conditions suivantes : (1) Ce dispositif ne doit pas provoquer de brouillage préjudiciable, et (2) il doit accepter tout brouillage reçu, y compris le brouillage pouvant entraîner un mauvais fonctionnement. Tous les changements ou modifications non expressément approuvés par Philips, sont susceptibles d'annuler le droit de l'utilisateur à se servir de cet équipement. Ce produit est exclusivement destiné à un usage commercial

# Disclaimer

The information in this guide is accurate at the time of writing. This guide is provided “as is” without expressed or implied warranty of any kind. Neither Philips nor its agents assume any liability for inaccuracies in this guide or losses incurred by use or misuse of the information in this guide.

Philips will not be liable for any indirect, special, incidental or consequential damages (including damages for loss of business, loss of profits or the like), whether based on breach of contract, tort (including negligence), product liability or otherwise, even if Philips or its representatives have been advised of the possibility of such damages.



©2015 Koninklijke Philips N.V. All rights reserved. Philips reserves the right to make changes in specifications and/or to discontinue any product at any time without notice or obligation and will not be liable for any consequences resulting from the use of this publication.

PLT-15127DG 09/16 philips.com

Philips Lighting  
North America Corporation  
10275 W. Higgins Road  
Rosemont IL 60018  
Tel: 800-322-2086  
Fax: 888-423-1882  
Customer/Technical Service:  
800-372-3331  
OEM Support: 866-915-5886

Philips Lighting Canada Ltd.  
281 Hillmount Rd.  
Markham, ON,  
Canada L6C 2S3  
Tel. 800-668-9008