

<b>929000708903</b>	
Brand Name	XITANIUM
Description	Xitanium 75W 0.1 – 1.05A Prog+ sXt
Input Voltage	120 ~ 230 ~ 277V
Input Frequency	50/60Hz
RoHS	Yes
Status	Active

## Electrical Specifications

Output Power (W)	Output Voltage (V)	Output Current (A)	Efficiency@ Max Load			Max Case Temp. (°C)	Input Current (Arms)			Max. Input Power (W)	Inrush Current (A <sub>pk</sub> /50%-μs)			THD @ Max Load (%)	Power Factor @ Max Load	Surge Protection Common/Diff (KV)	Weight (Lbs/kgs)
			120V	230V	277V		120 V	230 V	277 V		120 V <sub>in</sub>	230 V <sub>in</sub>	277 V <sub>in</sub>				
75	36 ~ 75	0.10 – 1.05	89.0	90.0	90.0	80 °C	0.71	0.37	0.31	85	50/160	100/160	120 / 160	<20	>0.95	4/4	2.8/ 1.27
			120V	230V	277V		120 V	230 V	277 V		120 V <sub>in</sub>	230 V <sub>in</sub>	277 V <sub>in</sub>				

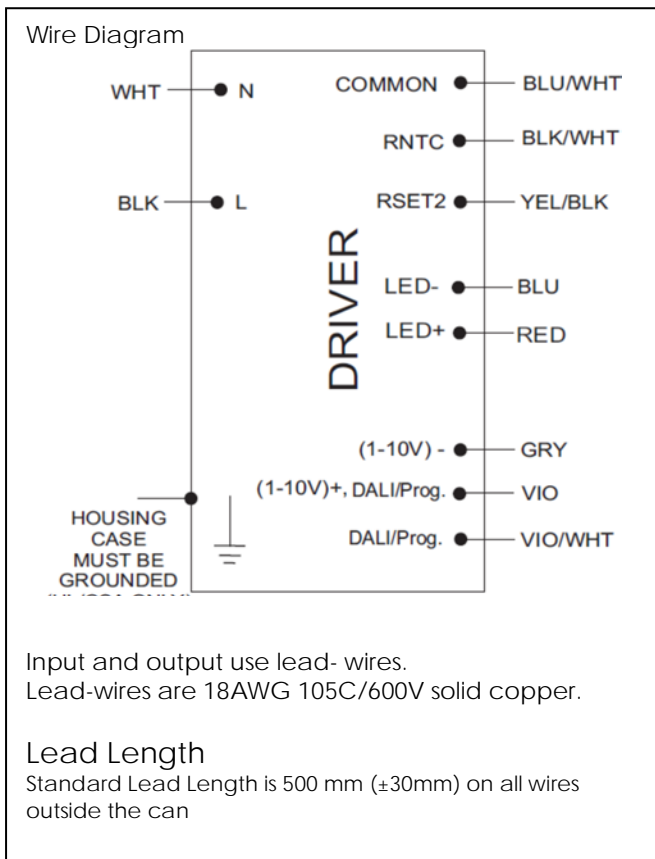

Dimming Method	Dimming Range	Minimum Output Current (A)	Min (typ.) Output Power(W)	Other Comments
1-10V Isolated	10% ~ 100%	0.050	25	Dimming source current: 150 μA (±3%)
DALI	1 ~ 254	10% ~ 100%	25	Linear or Logarithmic Variation
Amp Dimming	30% ~ 100%	0.050	25	Linear

## Enclosure



	in. (mm)
Case Length	8.38 (211.1)
Case Width	2.35 (59.1)
Case Height	1.47 (37.1)
Mounting Length	9.0 (226.2)
Mounting Width	1.7 (42.9)
Overall Length	9.54 (240.5)

Revised 09/01/2016



## Electrical Specifications

<b>929000708903</b>	
Brand Name	XITANIUM
Description	Xitanium 75W 0.1 – 1.05A Prog+ sXt
Input Voltage	120 ~ 230 ~ 277V
Input Frequency	50/60Hz
RoHS	Yes
Status	Preliminary

Product Data	
Order code	929000708903
Full product code	929000708903
Full product name	XITANIUM 75W 1.05A PROG+ GL-F SXT
Net weight per piece	1.27 KG / 2.8 lbs
Interfaces	1-10V Dimming, DALI, Amp Dimming, Integrated Dynadimmer, AOC, MTP, CLO, OTL
Ambient Temp Range	-40C to +55C
Corresponding Tcase	-15C to +80C
Line Voltage	120-277V
Line Current	0.71A @ 120V, 0.37 A @230V, 0.31A @ 277V
Line Frequency	50/60Hz
Life @ TC 70C	100000 hr [nom] refer to graph below
Life @ TC 80C	50000 hr [nom] refer to graph below
Suitable for Outdoor use?	Yes
Max TC	80C
Inrush current Width	Refer to table
Maximum ballast number on MCB 16A	11 [max]
Input Over-voltage	Can survive input over-voltage stress of 320VAC for 48 hours and 350VAC for 2 hours
LED Current Tolerance	+/- 5 %
Earth leakage current	0.7 mA [max]
Mains voltage safety (AC)	+/-10%
Mains voltage performance (AC)	+/-10%
Min. Mains voltage operational	108 V [min]
Max. Mains voltage operational	305V [max]
Output Current ripple	30% @ 1050 mA (ripple = pk-pk/avg)
THD total	< 20%
THD 3 <sup>rd</sup> Harmonic	< 15%
PF @ Max Load	>0.95
Wire Isolation	All wires are Double isolated to ground
Protections	Short Circuit and Open Circuit Protection for LED + and LED-
Standby power	<0.5W at 230V, 50Hz input

Installation & Application Notes:

### Section I – Physical Characteristics

- 1.1 LED Driver shall be installed inside an electrical enclosure
- 1.2 Wiring inside electrical enclosure shall comply with 600V/105°C rating or higher.

### Section II – Performance

- 2.1 LED Driver has a rated lifetime of 50,000 hours @ TC ≤80C.
- 2.2 LED Driver tolerates sustained open circuit and short circuit output conditions without damage.
- 2.3 LED Driver maximum allowable case temperature is 80°C – see product label for measurement location.
- 2.4 LED Driver reduces output power to LEDs if its case temperature >90°C.
- 2.5 LED Driver complies with the requirements of UL, CSA, FCC47 subpart I5, CE, ENEC, CISPR 15 Ed 7.2.

### I-10V Dimming Curve

Revised 03/27/2012

## PHILIPS LIGHTING ELECTRONICS N.A.

10275 WEST HIGGINS ROAD · ROSEMONT, IL 60018  
 Tel: 800-322-2086 · Fax: 888-423-1882 · www.philips.com/advance  
 Customer Support/Technical Service: 800-372-3331 · OEM Support: 866-915-5886

**929000708903**

Brand Name	XITANIUM
Description	Xitanium 75W 0.1 – 1.05A Prog+ sXt
Input Voltage	120 ~ 230 ~ 277V
Input Frequency	50/60Hz
RoHS	Yes
Status	Preliminary

## Electrical Specifications

Dimming source current from the driver: 150 $\mu$ A ( $\pm$ 3%)  
LED Current Tolerance at any value of Vdim:  $\pm$  5% of I<sub>max</sub>  
Minimum Dim Level: 10% - 100%

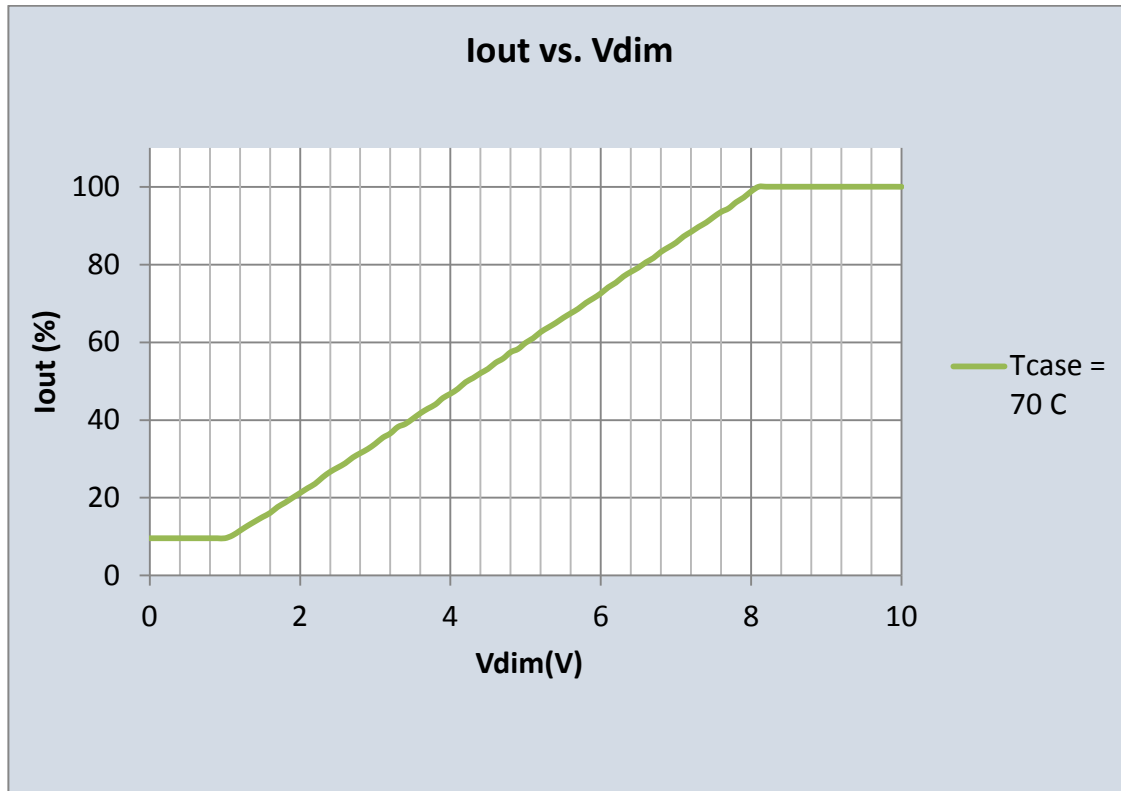

## AOC (Adjustable Output Current) Settings:

Revised 03/27/2012

**PHILIPS LIGHTING ELECTRONICS N.A.**  
10275 WEST HIGGINS ROAD · ROSEMONT, IL 60018  
Tel: 800-322-2086 · Fax: 888-423-1882 · [www.philips.com/advance](http://www.philips.com/advance)  
Customer Support/Technical Service: 800-372-3331 · OEM Support: 866-915-5886



<b>929000708903</b>	
Brand Name	XITANIUM
Description	Xtanium 75W 0.1 – 1.05A Prog+ sXt
Input Voltage	120 ~ 230 ~ 277V
Input Frequency	50/60Hz
RoHS	Yes
Status	Preliminary

## Electrical Specifications

LED current tolerance with variation of Rset2 is within  $\pm 5\%$  of I<sub>max</sub>

Rset(Ohms)	Current (mA)
0	100
100	100
110	105
120	111
130	116
150	125
160	130
180	138
200	146
220	155
240	166
270	176
300	190
330	204
360	215
390	228
430	245
470	261
510	277
560	297
620	318
680	340
750	368
820	392
910	422
1000	452
1100	485
1200	515
1300	545
1500	602
1600	632
1800	684
2000	733
2200	780
2400	823
2700	883
3000	941
3300	993
3600	1042
3900	1050
4300	1050
10000	1050
100000	1050

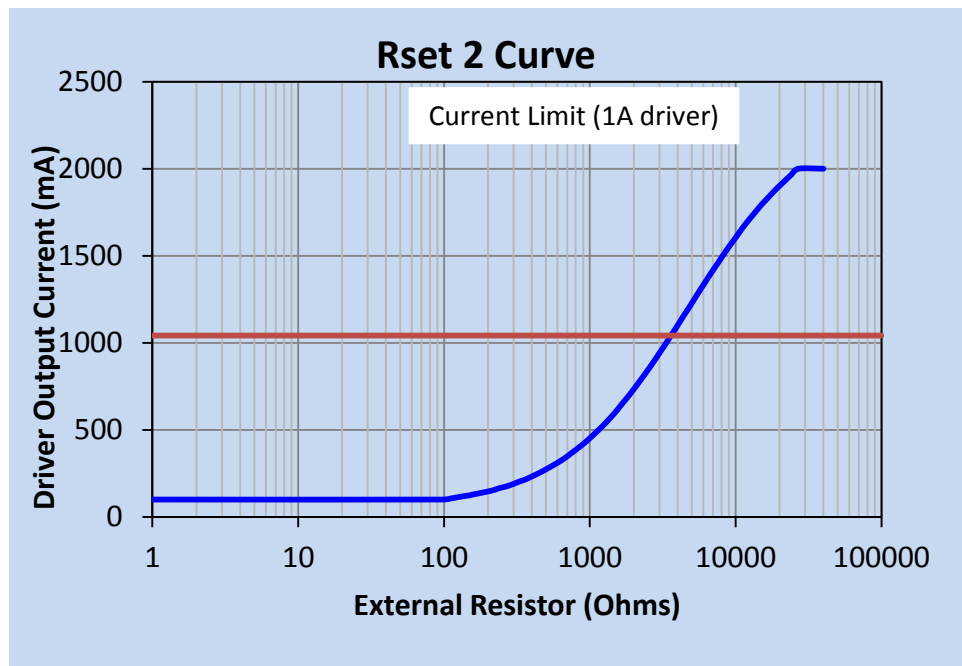

Operating Window:

Revised 03/27/2012

### PHILIPS LIGHTING ELECTRONICS N.A.

10275 WEST HIGGINS ROAD · ROSEMONT, IL 60018

Tel: 800-322-2086 · Fax: 888-423-1882 · [www.philips.com/advance](http://www.philips.com/advance)

Customer Support/Technical Service: 800-372-3331 · OEM Support: 866-915-5886

## Electrical Specifications

<b>929000708903</b>	
Brand Name	XITANIUM
Description	Xitanium 75W 0.1 – 1.05A Prog+ sXt
Input Voltage	120 ~ 230 ~ 277V
Input Frequency	50/60Hz
RoHS	Yes
Status	Preliminary

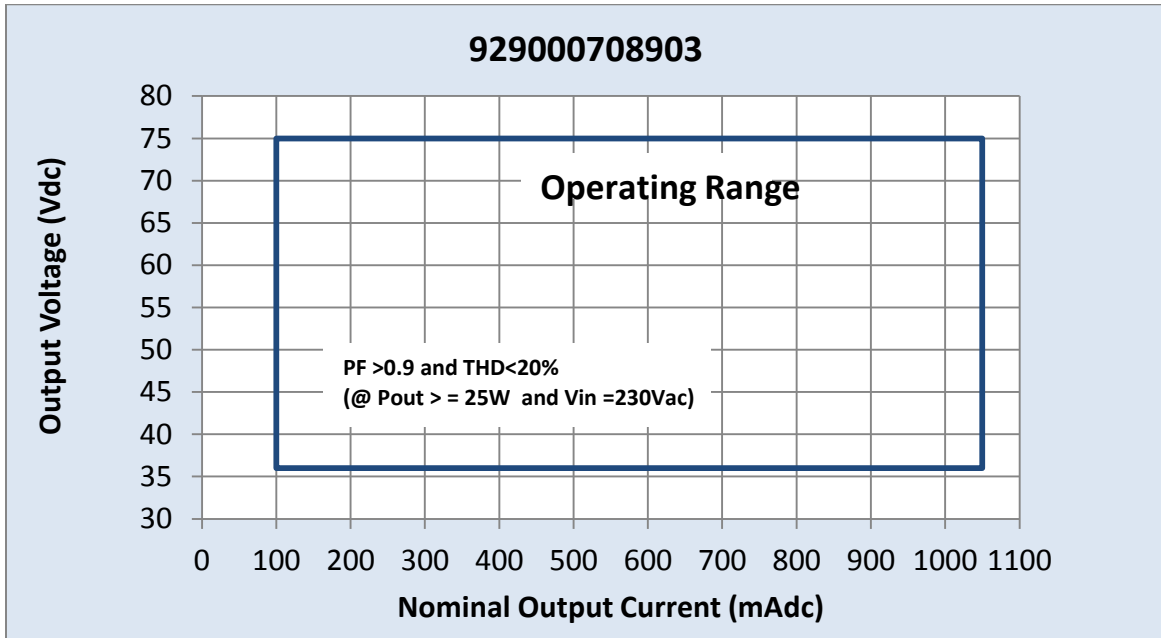

**Module Thermal Protection** can be implemented between 50C to 85C. Please refer to design guide for more details

Revised 03/27/2012

### PHILIPS LIGHTING ELECTRONICS N.A.

10275 WEST HIGGINS ROAD · ROSEMONT, IL 60018  
Tel: 800-322-2086 · Fax: 888-423-1882 · [www.philips.com/advance](http://www.philips.com/advance)  
Customer Support/Technical Service: 800-372-3331 · OEM Support: 866-915-5886



<b>929000708903</b>	
Brand Name	XITANIUM
Description	Xtanium 75W 0.1 – 1.05A Prog+ sXt
Input Voltage	120 ~ 230 ~ 277V
Input Frequency	50/60Hz
RoHS	Yes
Status	Preliminary

### Electrical Specifications

**Two NTC parts can be used:**

NTC1 from Murata Part Number NCPI8XH103J03RB

NTC2 from Murata Part Number NCPI5XW153E03RC

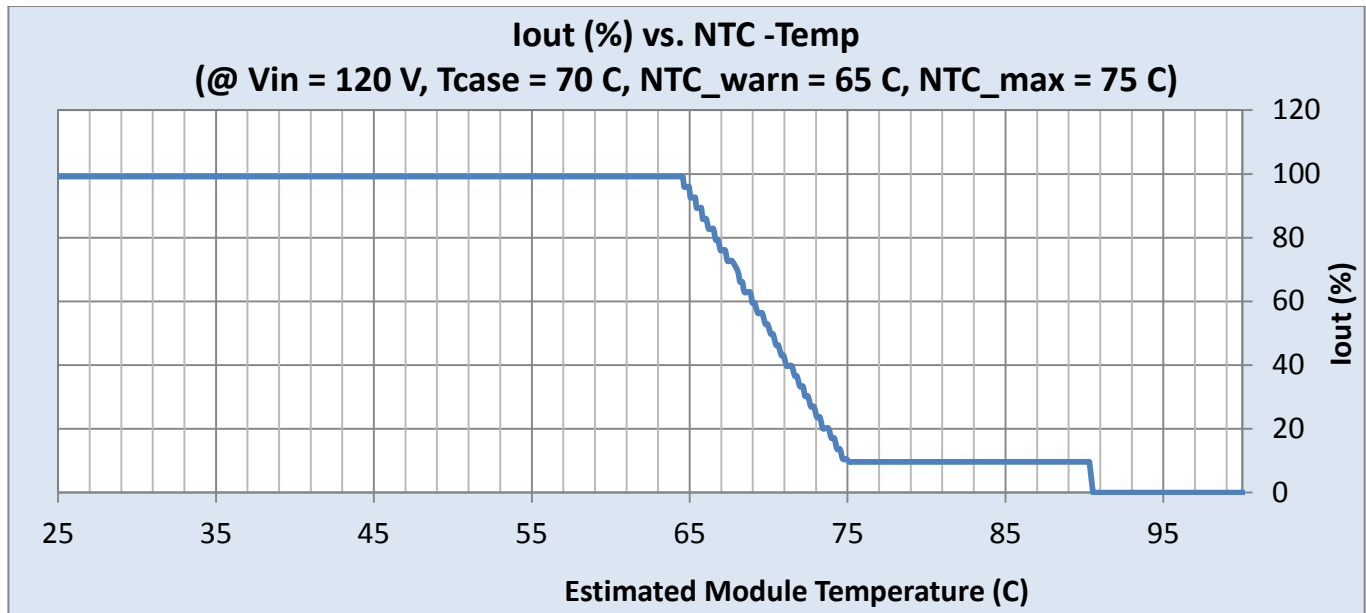

Revised 03/27/2012

**929000708903**

Brand Name	XITANIUM
Description	Xtanium 75W 0.1 – 1.05A Prog+ sXt
Input Voltage	120 ~ 230 ~ 277V
Input Frequency	50/60Hz
RoHS	Yes
Status	Preliminary

## Electrical Specifications

### AmpDim Curve:

Parameter	Min	Max	Increments
Start Voltage	170Vrms	250Vrms	1Vrms(configurable by software)
Stop Voltage	150Vrms	230Vrms	1Vrms(configurable by software)
Start Percentage	30%	100%	1%(configurable by software)
Stop Percentage	30%	100%	1%(configurable by software)

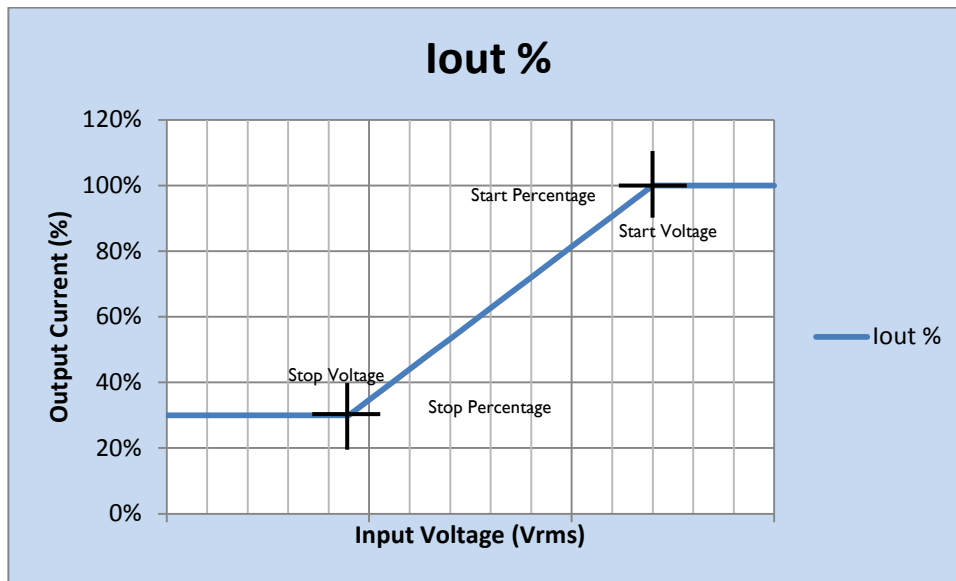

Revised 03/27/2012



**929000708903**

Brand Name	XITANIUM
Description	Xtanium 75W 0.1 – 1.05A Prog+ sXt
Input Voltage	120 ~ 230 ~ 277V
Input Frequency	50/60Hz
RoHS	Yes
Status	Preliminary

Electrical Specifications

### Output Voltage vs. Efficiency

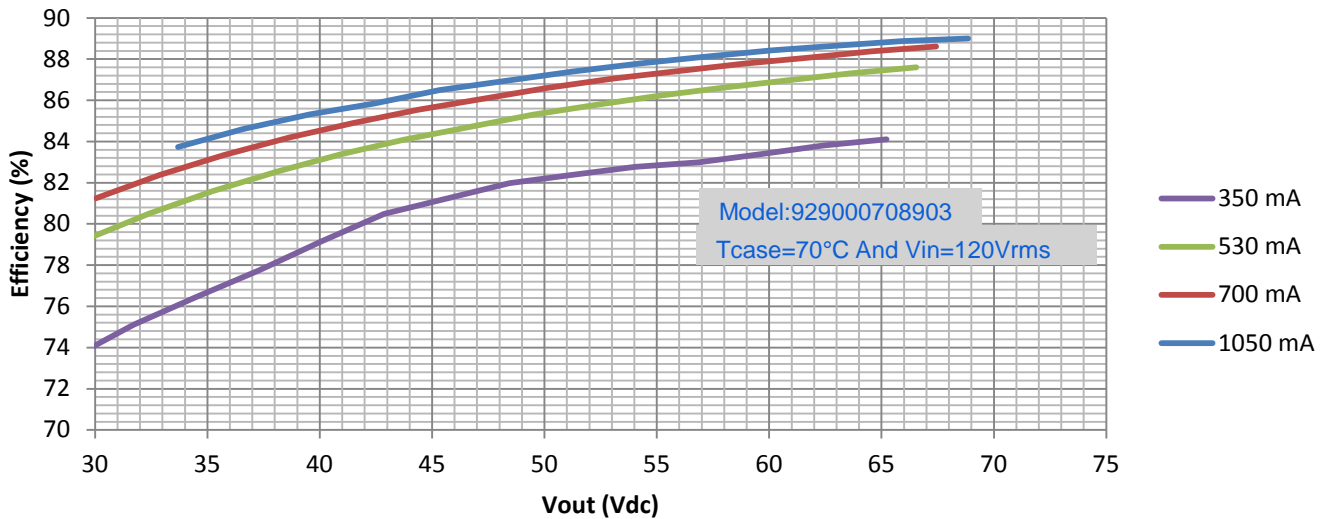

### Output Voltage vs. Efficiency

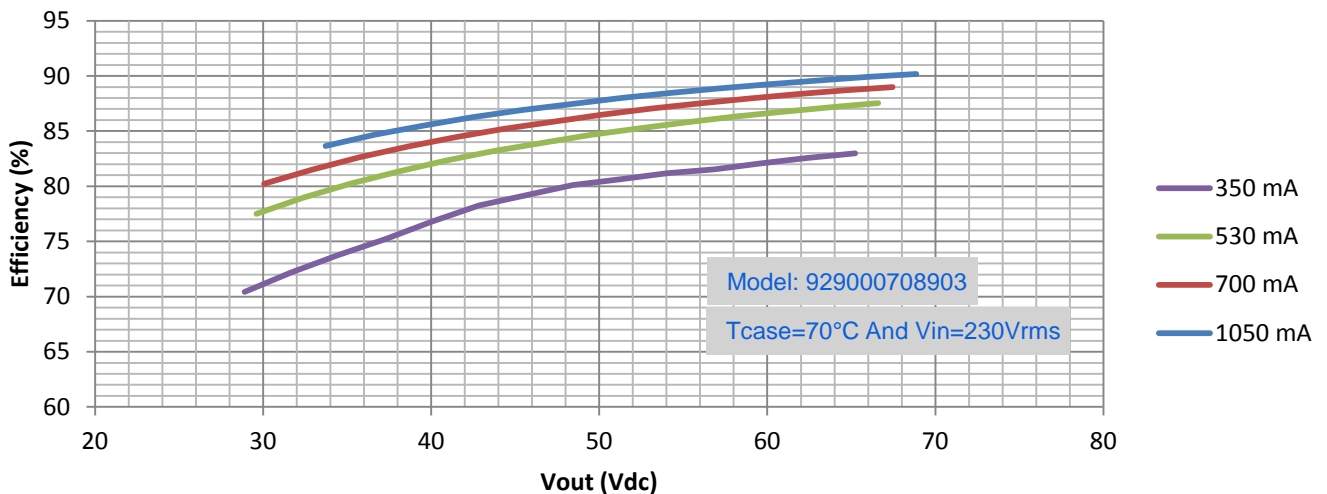

Revised 03/27/2012





<b>929000708903</b>	
Brand Name	XITANIUM
Description	Xitaniium 75W 0.1 – 1.05A Prog+ sXt
Input Voltage	120 ~ 230 ~ 277V
Input Frequency	50/60Hz
RoHS	Yes
Status	Preliminary

### Electrical Specifications

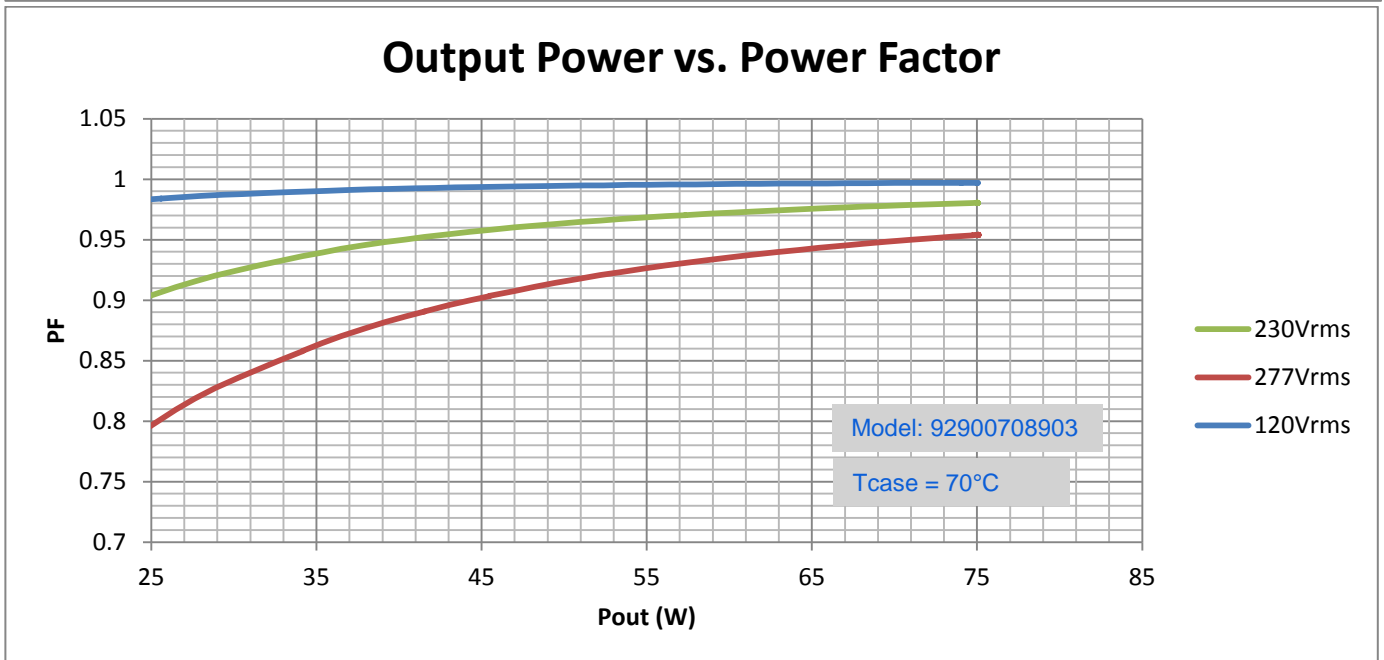
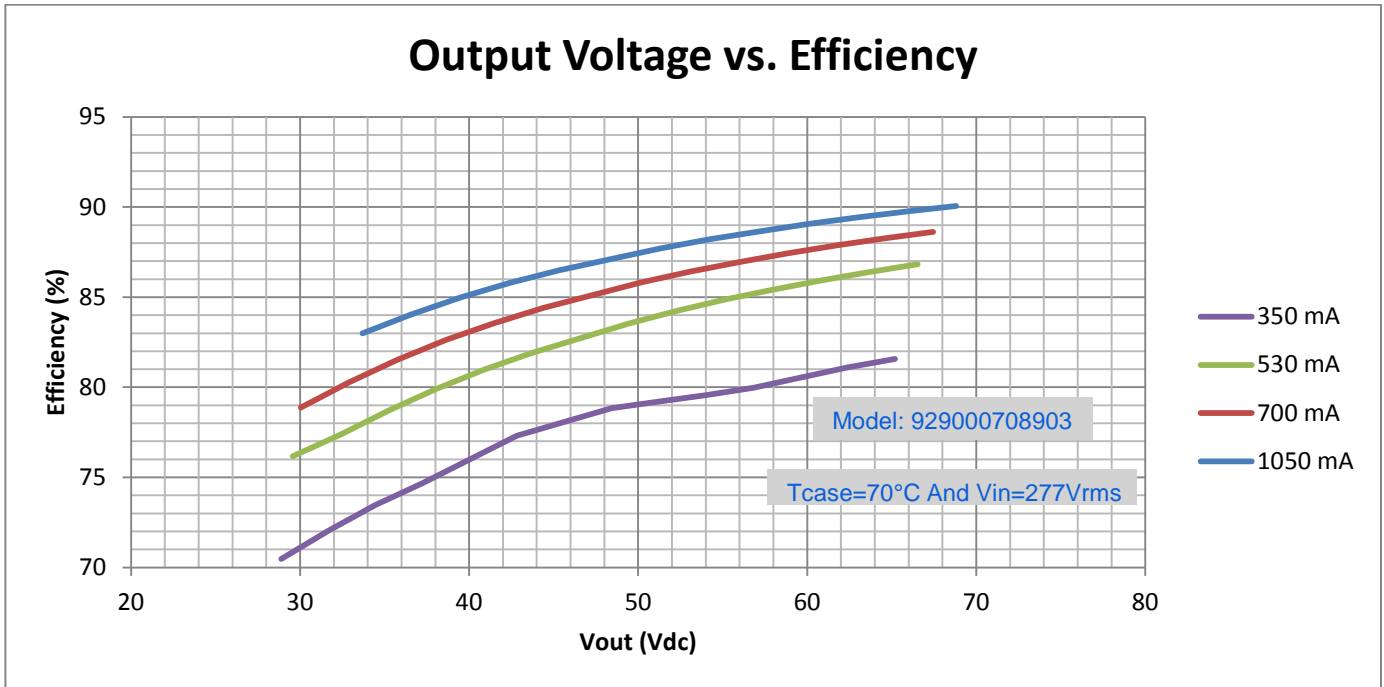

Revised 03/27/2012



**929000708903**

Brand Name	XITANIUM
Description	Xtanium 75W 0.1 – 1.05A Prog+ sXt
Input Voltage	120 ~ 230 ~ 277V
Input Frequency	50/60Hz
RoHS	Yes
Status	Preliminary

Electrical Specifications

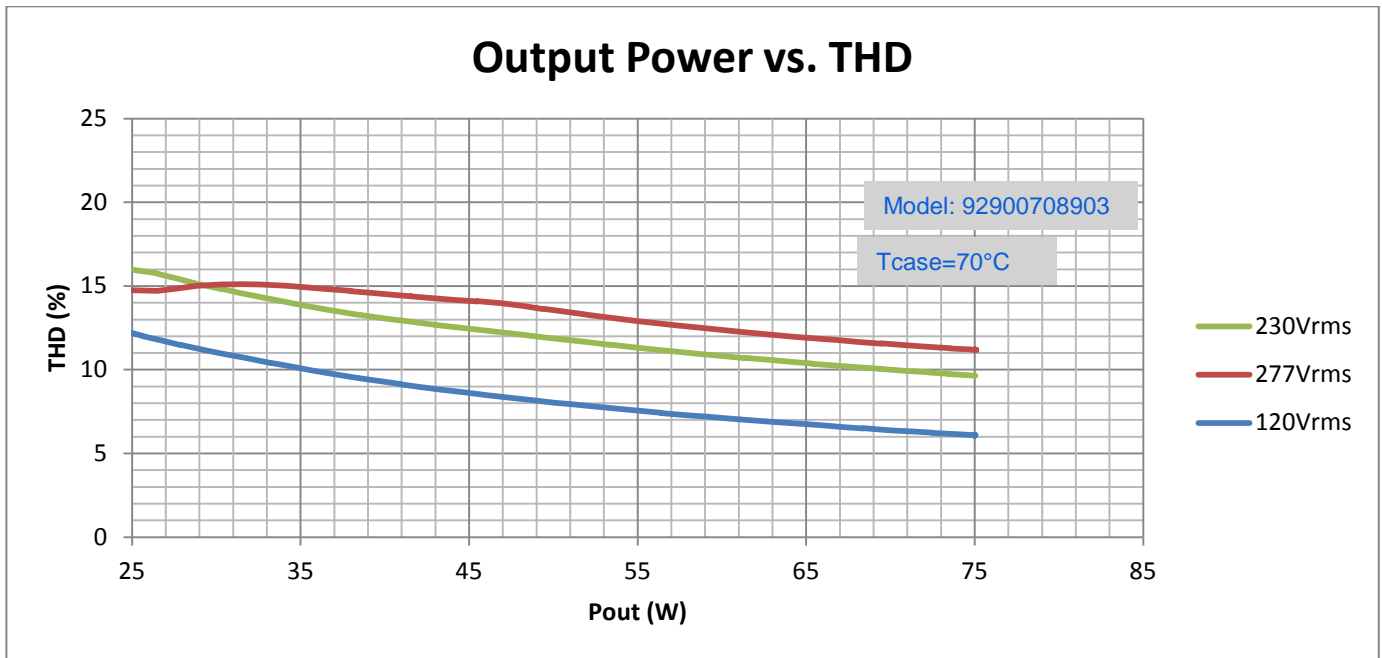

Programming Tool:

For latest version please check [www.philips.com/xitanium](http://www.philips.com/xitanium)

Revised 03/27/2012

**PHILIPS LIGHTING ELECTRONICS N.A.**  
10275 WEST HIGGINS ROAD · ROSEMONT, IL 60018  
Tel: 800-322-2086 · Fax: 888-423-1882 · [www.philips.com/advance](http://www.philips.com/advance)  
Customer Support/Technical Service: 800-372-3331 · OEM Support: 866-915-5886

**929000708903**

Brand Name	XITANIUM
Description	Xtanium 75W 0.1 – 1.05A Prog+ sXt
Input Voltage	120 ~ 230 ~ 277V
Input Frequency	50/60Hz
RoHS	Yes
Status	Preliminary

## Electrical Specifications

### I<sub>out</sub> vs. T<sub>case</sub> of Driver:

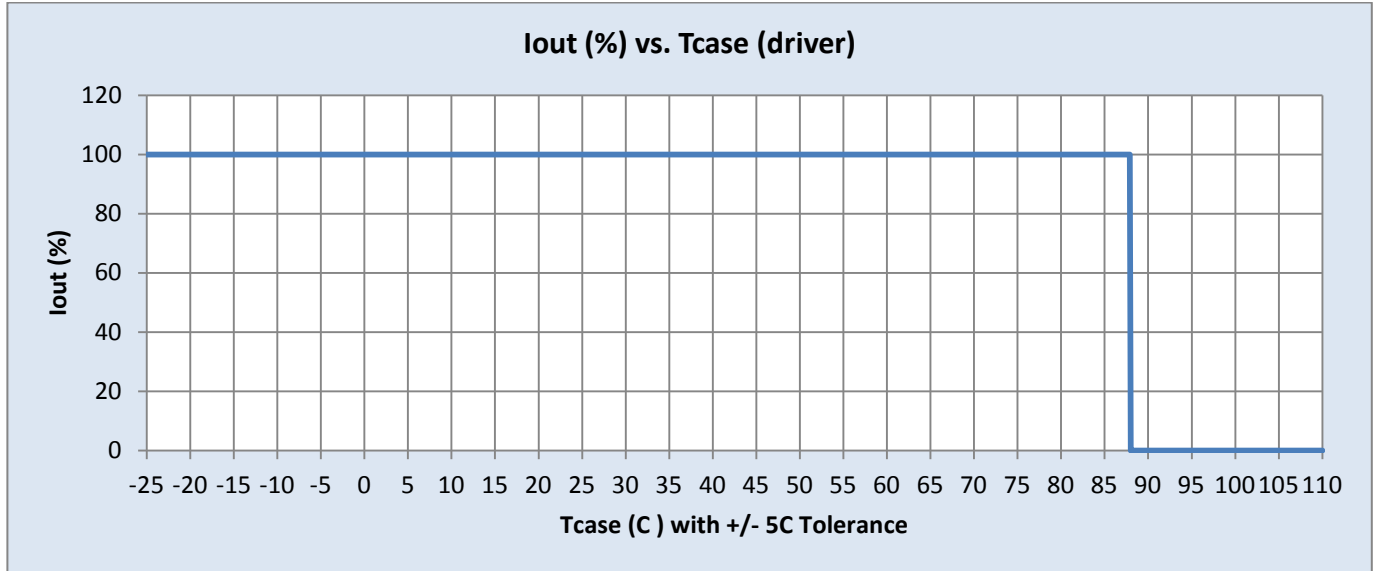

### Inrush Current Info:

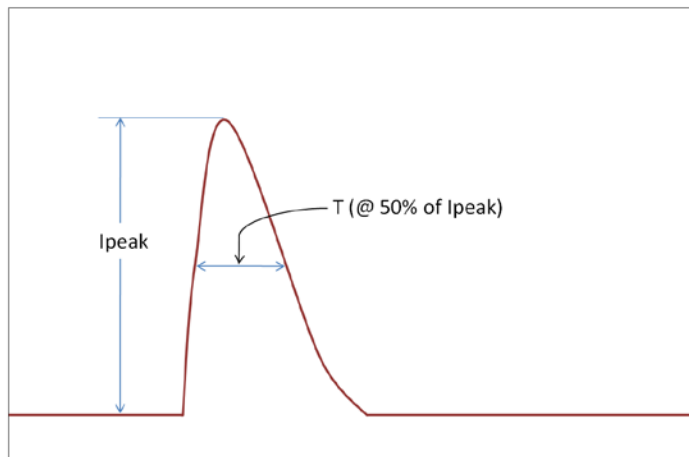

V <sub>in</sub>	I <sub>peak</sub>	T (@ 50% of I <sub>peak</sub> )
120 Vrms	50 A	160 μs
230 Vrms	100 A	160 μs
277 Vrms	120 A	160 μs

Revised 03/27/2012

## PHILIPS LIGHTING ELECTRONICS N.A.

10275 WEST HIGGINS ROAD · ROSEMONT, IL 60018  
 Tel: 800-322-2086 · Fax: 888-423-1882 · [www.philips.com/advance](http://www.philips.com/advance)  
 Customer Support/Technical Service: 800-372-3331 · OEM Support: 866-915-5886



**929000708903**

<b>929000708903</b>	
Brand Name	XITANIUM
Description	Xtanium 75W 0.1 – 1.05A Prog+ sXt
Input Voltage	120 ~ 230 ~ 277V
Input Frequency	50/60Hz
RoHS	Yes
Status	Preliminary

Electrical Specifications

**Lifetime vs. Tcase of Driver:**

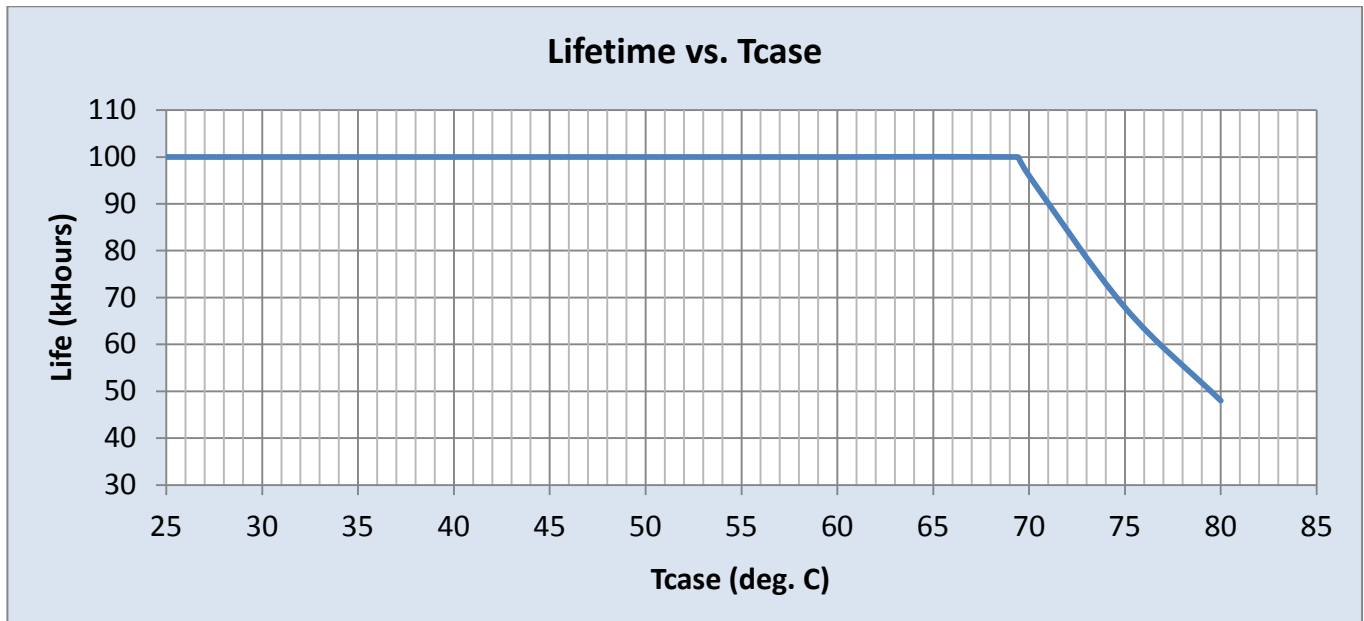

**Failure Rate Info based upon MTBF modeling:**

- 90% survivals at end of life @<=Tcase 70°C
- 

**Failure Rate Info based upon field call rate data:**

- <0.01% per 1 kHr @<= Tcase 70 C

**Isolation:**

Isolation	Input Wires	Output Wires	DALI Wires	0-10V Wires	Chassis
Input Wires	NA	1750	1750	1750	3750
Output Wires + Control Wires	1750	NA	1750	1750	3750
DALI Wires	1750	1750	NA	NA	3750
0-10V Wires	1750	1750	NA	NA	3750
Chassis	3750	3750	3750	3750	NA

Revised 03/27/2012

**PHILIPS LIGHTING ELECTRONICS N.A.**

10275 WEST HIGGINS ROAD · ROSEMONT, IL 60018  
 Tel: 800-322-2086 · Fax: 888-423-1882 · www.philips.com/advance  
 Customer Support/Technical Service: 800-372-3331 · OEM Support: 866-915-5886