

PHILIPS

LED Modules

Fortimo SLM

1216 L23 2828 G6



Philips Fortimo LED spotlight module (SLM) gen 6 continues to focus on the combination of quality of light and performance. By offering the CoB separate from the holder, even more flexibility in possible system combinations and specifications is achieved. This results in an extensive portfolio of lumen ranges, CCTs and spectra. Please also check the online Easy Design-in Tool for your perfect system combination (www.na.easydesignintool.philips.com).

Ordering Data

Commercial product name	12NC	Minimum order quantity
Fortimo SLM C 730 1216 L23 2828 G6	9290 014 35206	10
Fortimo SLM C 740 1216 L23 2828 G6	9290 014 48606	10
Fortimo SLM C 750 1216 L23 2828 G6	9290 014 35306	10
Fortimo SLM C 757 1216 L23 2828 G6	9290 014 35406	10
Fortimo SLM C 827 1216 L23 2828 G6	9290 014 49306	10
Fortimo SLM C 830 1216 L23 2828 G6	9290 014 48806	10
Fortimo SLM C 835 1216 L23 2828 G6	9290 014 48906	10
Fortimo SLM C 840 1216 L23 2828 G6	9290 014 49006	10
Fortimo SLM C 850 1216 L23 2828 G6	9290 014 49106	10
Fortimo SLM C 857 1216 L23 2828 G6	9290 014 49206	10
Fortimo SLM C 930 1216 L23 2828 G6	9290 014 49406	10

Not all products are currently available as make-to-stock. Please contact your local Philips representative for specific availability and lead time.

Fortimo SLM 1216 L23 2828 G6

Features

- Excellent quality of light available for all applications
- Extensive range of CCT
- Small LES for narrow beam angles and small reflector designs
- Flexibility to select a different lumen output between 800 lm and 10000 lm
- State-of-the-art chip-on-board (CoB) technology, enabling high system efficacy
- System proposition (CoB + holder + driver)

- Flexibility to optimize luminaire performance (lm/W or high lumen output)
- Philips Advance Xitanium LED window drivers with SimpleSet technology for maximum flexibility
- Mini drivers for smallest possible luminaire designs
- Three dedicated product lines:
 - SLM gen 6 premium white
 - SLM gen 6 crisp white
 - SLM gen 6 food

Benefits

- 5-year limited system warranty with over 50,000 hours lifetime¹

Applications

- Architectural lighting
- Retail spot lighting
- Recessed downlight

Drive Currents

Parameter	Nominal*	Life**	Max***	Unit
Fortimo LED SLM 1211 L19 2828 G6	1600	2190	2400	mA

Module Temperatures

Parameter	Nominal*	Life**	Max***	Unit
Tc (case temperature at Tc point)	85	85	95	°C

* Nominal value at which typical performance is specified

** Value at which life time is specified

*** Maximum value for safe operation, do not operate above this value

1. View limited warranty at <http://www.usa.lighting.philips.com/support/support/warranty> for details and restrictions.

Fortimo SLM 1216 L23 2828 G6

Optical Characteristics – Table per CCT

Fortimo SLM C 730 1216 L23 2828 G6

Parameter	Min	Typ	Max	Unit
Luminous Flux	7300	8110	8920	lm
Module Efficiency		147		lm/W
Correlated Color Temperature (CCT)		3000		K
Color Coordinates (CIEx, CIEy)		(0.434, 0.403)		–
Color Consistency			3	SDCM
CRI	70	72		–

At currents higher than 1824 mA the module might be classified as RG2.

Measurement precision for flux +/- 5%.
 Measurement precision for efficacy +/- 6%.
 Measurement precision for x, y +/- 0.005.
 Measurement precision for CRI +/- 1.5.

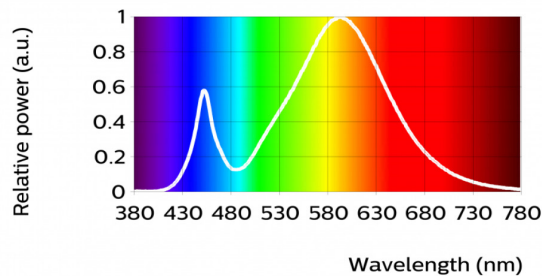

R1	R2	R3	R4	R5	R6	R7	R8	R9	R10	R11	R12	R13	R14	R15
67	83	94	65	66	75	77	44	-30	59	57	48	70	97	

Fortimo SLM C 740 1216 L23 2828 G6

Parameter	Min	Typ	Max	Unit
Luminous Flux	7720	8580	9430	lm
Module Efficiency		155		lm/W
Correlated Color Temperature (CCT)		4000		K
Color Coordinates (CIEx, CIEy)		(0.382, 0.380)		–
Color Consistency			3	SDCM
CRI	70	72		–

At currents higher than 1824 mA the module might be classified as RG2.

Measurement precision for flux +/- 5%.
 Measurement precision for efficacy +/- 6%.
 Measurement precision for x, y +/- 0.005.
 Measurement precision for CRI +/- 1.5.

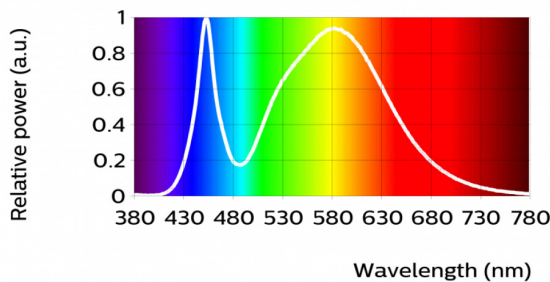

R1	R2	R3	R4	R5	R6	R7	R8	R9	R10	R11	R12	R13	R14	R15
71	81	89	71	70	72	83	54	-22	54	65	43	73	93	

Fortimo SLM 1216 L23 2828 G6

Optical Characteristics – Table per CCT

Fortimo SLM C 750 1216 L23 2828 G6

Parameter	Min	Typ	Max	Unit
Luminous Flux	7700	8550	9410	lm
Module Efficiency		155		lm/W
Correlated Color Temperature (CCT)		5000		K
Color Coordinates (CIEx, CIEy)		(0.345, 0.355)		–
Color Consistency			3	SDCM
CRI	70	72		–

At currents higher than 1824 mA the module might be classified as RG2.

Measurement precision for flux +/- 5%.
 Measurement precision for efficacy +/- 6%.
 Measurement precision for x, y +/- 0.005.
 Measurement precision for CRI +/- 1.5.

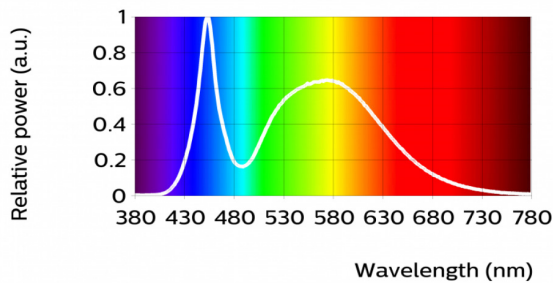

R1	R2	R3	R4	R5	R6	R7	R8	R9	R10	R11	R12	R13	R14	R15
73	82	86	74	73	73	83	59	-18	54	69	47	75	92	

Fortimo SLM C 757 1216 L23 2828 G6

Parameter	Min	Typ	Max	Unit
Luminous Flux	7540	8770	9210	lm
Module Efficiency		152		lm/W
Correlated Color Temperature (CCT)		5700		K
Color Coordinates (CIEx, CIEy)		(0.329, 0.342)		–
Color Consistency			3	SDCM
CRI	70	72		–

At currents higher than 1824 mA the module might be classified as RG2.

Measurement precision for flux +/- 5%.
 Measurement precision for efficacy +/- 6%.
 Measurement precision for x, y +/- 0.005.
 Measurement precision for CRI +/- 1.5.

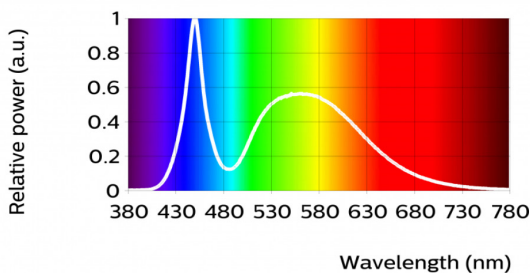

R1	R2	R3	R4	R5	R6	R7	R8	R9	R10	R11	R12	R13	R14	R15
71	77	80	74	72	68	82	61	-23	45	71	43	72	89	

Fortimo SLM 1216 L23 2828 G6

Optical Characteristics – Table per CCT

Fortimo SLM C 827 1216 L23 2828 G6

Parameter	Min	Typ	Max	Unit
Luminous Flux	6630	7370	8110	lm
Module Efficiency		134		lm/W
Correlated Color Temperature (CCT)		2700		K
Color Coordinates (CIEx, CIEy)		(0.458, 0.410)		–
Color Consistency			3	SDCM
CRI	80	82		–

At currents higher than 1824 mA the module might be classified as RG2.

Measurement precision for flux +/- 5%.
Measurement precision for efficacy +/- 6%.
Measurement precision for x, y +/- 0.005.
Measurement precision for CRI +/- 1.5.

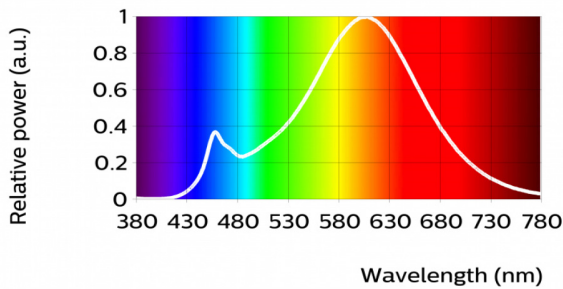

R1	R2	R3	R4	R5	R6	R7	R8	R9	R10	R11	R12	R13	R14	R15
79	92	94	76	79	90	82	59	12	82	72	73	82	97	

Fortimo SLM C 830 1216 L23 2828 G6

Parameter	Min	Typ	Max	Unit
Luminous Flux	6790	7550	8300	lm
Module Efficiency		137		lm/W
Correlated Color Temperature (CCT)		3000		K
Color Coordinates (CIEx, CIEy)		(0.434, 0.403)		–
Color Consistency			3	SDCM
CRI	80	82		–

At currents higher than 1824 mA the module might be classified as RG2.

Measurement precision for flux +/- 5%.
Measurement precision for efficacy +/- 6%.
Measurement precision for x, y +/- 0.005.
Measurement precision for CRI +/- 1.5.

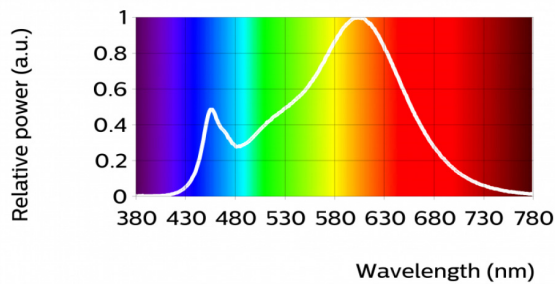

R1	R2	R3	R4	R5	R6	R7	R8	R9	R10	R11	R12	R13	R14	R15
83	94	93	80	84	94	81	59	12	87	80	76	86	97	

Fortimo SLM 1216 L23 2828 G6

Optical Characteristics – Table per CCT

Fortimo SLM C 835 1216 L23 2828 G6

Parameter	Min	Typ	Max	Unit
Luminous Flux	6930	7700	8470	lm
Module Efficiency		140		lm/W
Correlated Color Temperature (CCT)		3500		K
Color Coordinates (CIEx, CIEy)		(0.407, 0.392)		–
Color Consistency			3	SDCM
CRI	80	82		–

At currents higher than 1824 mA the module might be classified as RG2.

Measurement precision for flux +/- 5%.
 Measurement precision for efficacy +/- 6%.
 Measurement precision for x, y +/- 0.005.
 Measurement precision for CRI +/- 1.5.

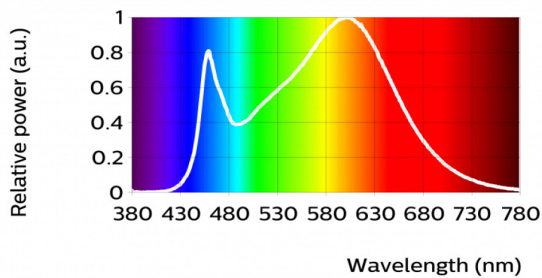

R1	R2	R3	R4	R5	R6	R7	R8	R9	R10	R11	R12	R13	R14	R15
86	96	93	80	85	94	83	65	65	90	79	70	89	97	

Fortimo SLM C 840 1216 L23 2828 G6

Parameter	Min	Typ	Max	Unit
Luminous Flux	7200	8000	8800	lm
Module Efficiency		145		lm/W
Correlated Color Temperature (CCT)		4000		K
Color Coordinates (CIEx, CIEy)		(0.382, 0.380)		–
Color Consistency			3	SDCM
CRI	80	82		–

At currents higher than 1824 mA the module might be classified as RG2.

Measurement precision for flux +/- 5%.
 Measurement precision for efficacy +/- 6%.
 Measurement precision for x, y +/- 0.005.
 Measurement precision for CRI +/- 1.5.

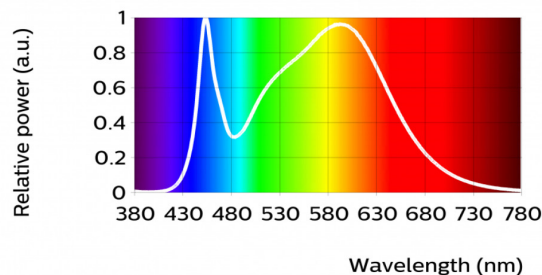

R1	R2	R3	R4	R5	R6	R7	R8	R9	R10	R11	R12	R13	R14	R15
80	89	96	79	80	85	86	63	13	74	77	58	82	98	

Fortimo SLM 1216 L23 2828 G6

Optical Characteristics – Table per CCT

Fortimo SLM C 850 1216 L23 2828 G6

Parameter	Min	Typ	Max	Unit
Luminous Flux	7200	8000	8800	lm
Module Efficiency		145		lm/W
Correlated Color Temperature (CCT)		5000		K
Color Coordinates (CIEx, CIEy)		(0.345, 0.355)		–
Color Consistency			3	SDCM
CRI	80	82		–

At currents higher than 1824 mA the module might be classified as RG2.

Measurement precision for flux +/- 5%.
Measurement precision for efficacy +/- 6%.
Measurement precision for x, y +/- 0.005.
Measurement precision for CRI +/- 1.5.

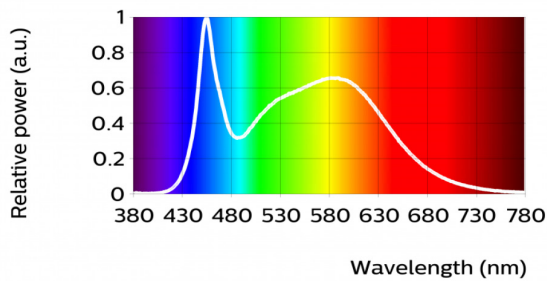

R1	R2	R3	R4	R5	R6	R7	R8	R9	R10	R11	R12	R13	R14	R15
83	92	95	80	82	87	86	68	14	79	78	58	86	98	

Fortimo SLM C 857 1216 L23 2828 G6

Parameter	Min	Typ	Max	Unit
Luminous Flux	6930	7700	8470	lm
Module Efficiency		140		lm/W
Correlated Color Temperature (CCT)		5700		K
Color Coordinates (CIEx, CIEy)		(0.329, 0.342)		–
Color Consistency			3	SDCM
CRI	80	82		–

At currents higher than 1824 mA the module might be classified as RG2.

Measurement precision for flux +/- 5%.
Measurement precision for efficacy +/- 6%.
Measurement precision for x, y +/- 0.005.
Measurement precision for CRI +/- 1.5.

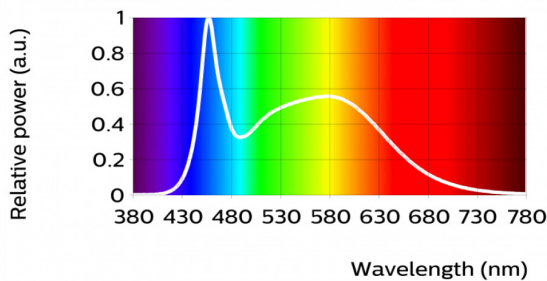

R1	R2	R3	R4	R5	R6	R7	R8	R9	R10	R11	R12	R13	R14	R15
82	93	95	79	83	88	86	68	14	82	78	61	87	98	

Fortimo SLM 1216 L23 2828 G6

Optical Characteristics – Table per CCT

Fortimo SLM C 930 1216 L23 2828 G6				
Parameter	Min	Typ	Max	Unit
Luminous Flux	5710	6340	6980	lm
Module Efficiency		115		lm/W
Correlated Color Temperature (CCT)		3000		K
Color Coordinates (CIEx, CIEy)		(0.434, 0.403)		–
Color Consistency			3	SDCM
CRI	90	92		–

At currents higher than 1824 mA the module might be classified as RG2.

Measurement precision for flux +/- 5%.
 Measurement precision for efficacy +/- 6%.
 Measurement precision for x, y +/- 0.005.
 Measurement precision for CRI +/- 1.5.

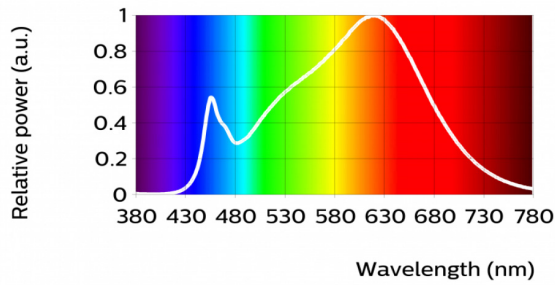

R1	R2	R3	R4	R5	R6	R7	R8	R9	R10	R11	R12	R13	R14	R15
93	97	99	97	92	96	91	81	68	82	91	77	94	99	

Fortimo SLM 1216 L23 2828 G6

Beam Shape

Bare CoB

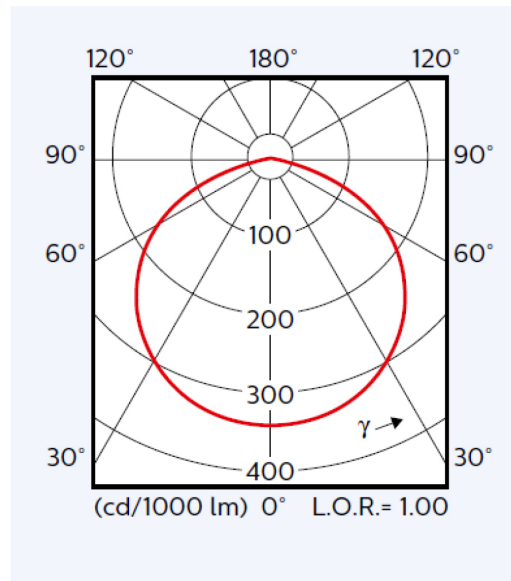

CoB with a poke-in holder

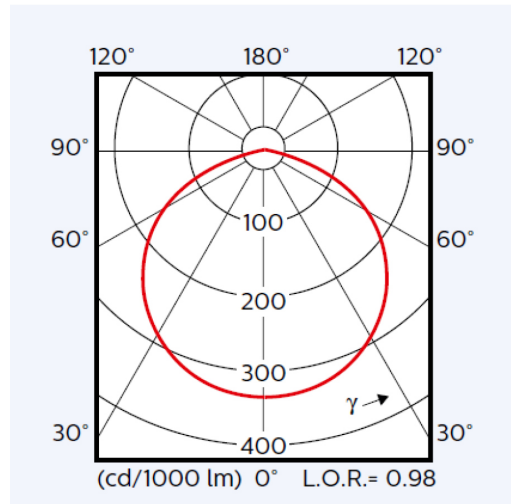

Fortimo SLM 1216 L23 2828 G6

[Fortimo SLM C 730 1216 L23 2828 G6](#)

[Fortimo SLM C 740 1216 L23 2828 G6](#)

[Fortimo SLM C 750 1216 L23 2828 G6](#)

[Fortimo SLM C 757 1216 L23 2828 G6](#)

[Fortimo SLM C 857 1216 L23 2828 G6](#)

Parameter	Min	Typ	Max	Unit
Forward Voltage		34.4	36.9	V
Power Consumption		55.2	59.1	W
Thermal Power		30.8		W

Measurement precision for Vf +/- 3%. Measurement precision for power +/- 3.3%.

[Fortimo SLM C 827 1216 L23 2828 G6](#)

[Fortimo SLM C 830 1216 L23 2828 G6](#)

[Fortimo SLM C 835 1216 L23 2828 G6](#)

[Fortimo SLM C 840 1216 L23 2828 G6](#)

[Fortimo SLM C 850 1216 L23 2828 G6](#)

Parameter	Min	Typ	Max	Unit
Forward Voltage		34.4	36.9	V
Power Consumption		55.1	59.0	W
Thermal Power		32.2		W

Measurement precision for Vf +/- 3%. Measurement precision for power +/- 3.3%.

[Fortimo SLM C 930 1216 L23 2828 G6](#)

Parameter	Min	Typ	Max	Unit
Forward Voltage		34.4	36.9	V
Power Consumption		55.1	59.0	W
Thermal Power		33.7		W

Measurement precision for Vf +/- 3%. Measurement precision for power +/- 3.3%.

Fortimo SLM 1216 L23 2828 G6

Tuning Information

Flux and efficacy vs. current (at Tc nominal)

I [mA]	Flux [%]	Efficacy [%]
1050	70	111
1200	79	108
1500	95	102
1600	100	100
1800	110	96
2000	119	93
2200	128	91
2400	137	88

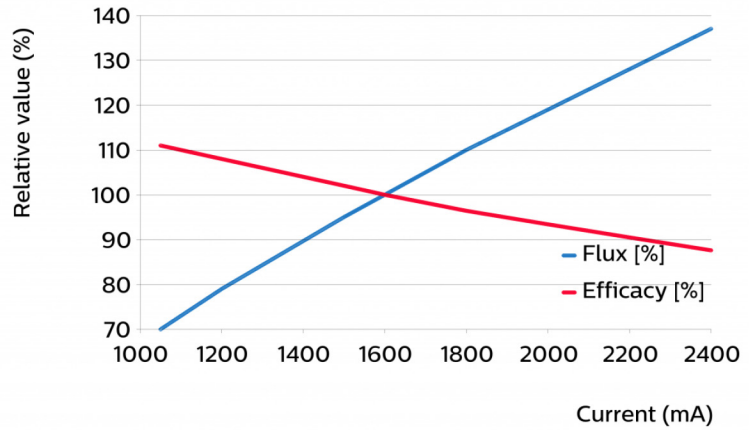

Flux and efficacy vs. temperature at Tc (at I nominal)

Tcase [°C]	Flux [%]	Efficacy [%]
55	108	106
65	105	104
75	103	102
85	100	100
95	97	98

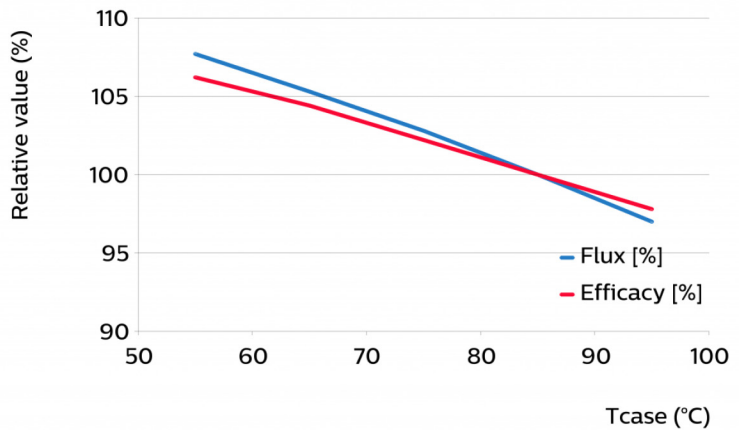

Fortimo SLM 1216 L23 2828 G6

Lumen Maintenance

Lumen maintenance at I-life and Tc-life conditions

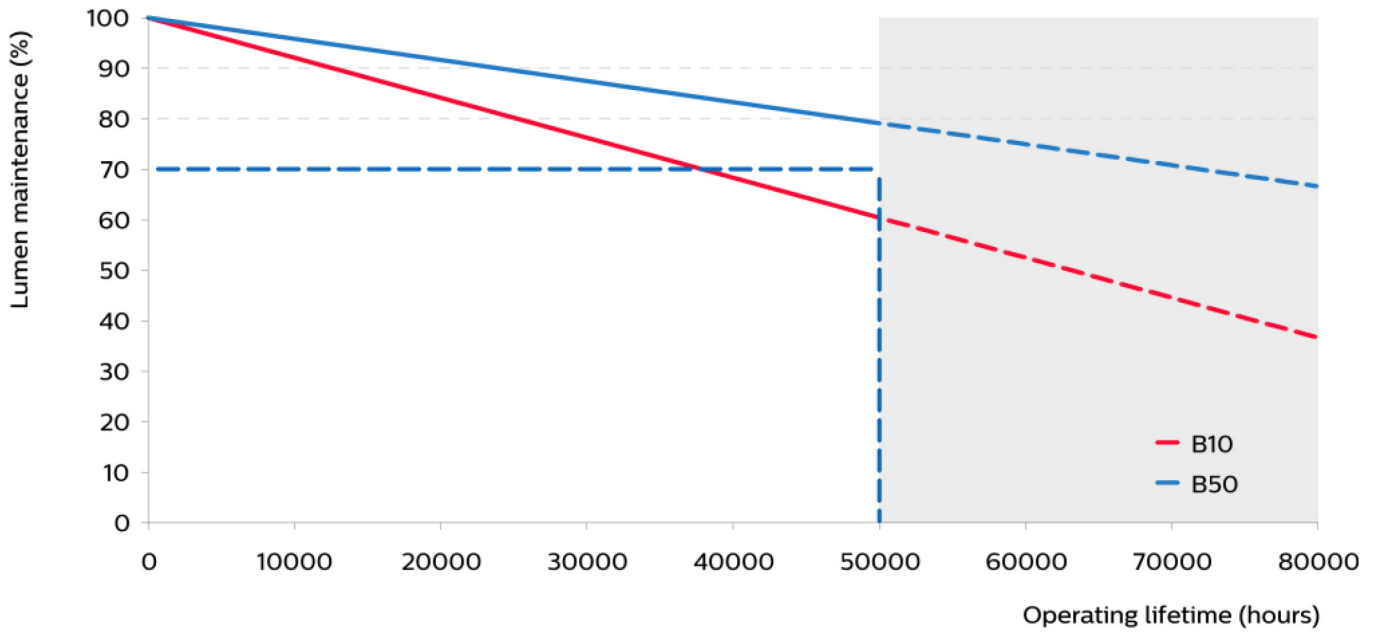

Lumen maintenance for B50 at current I-life conditions

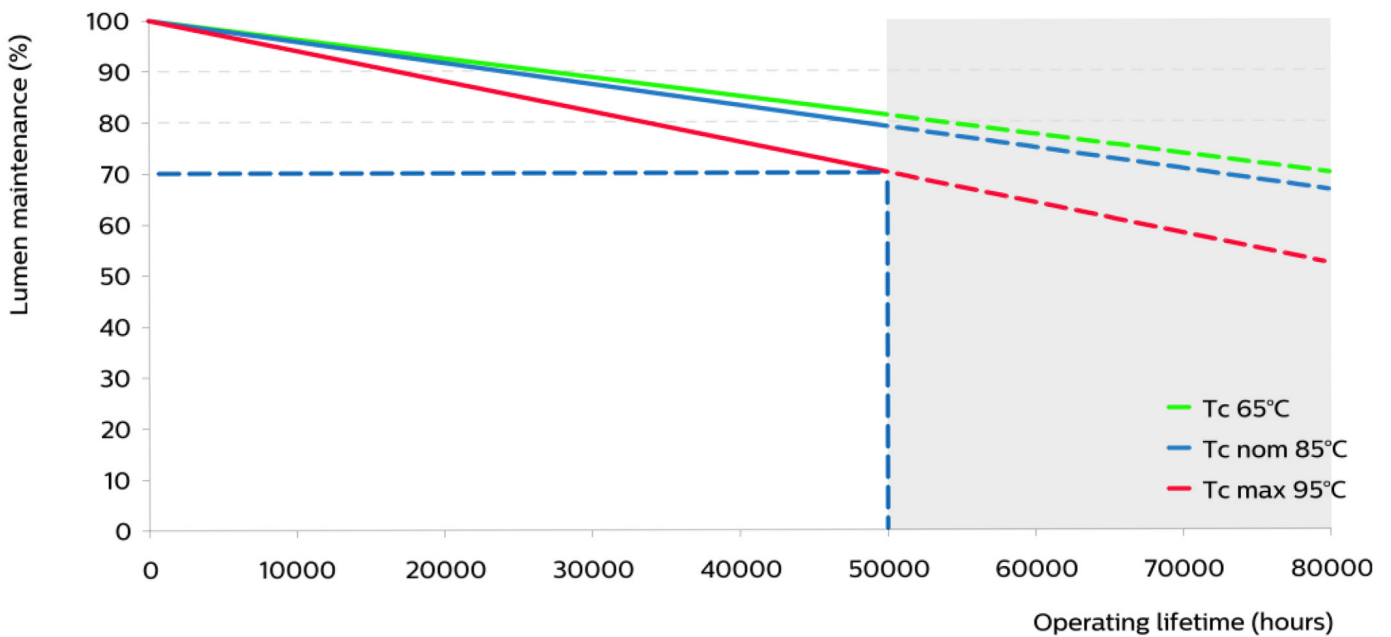

Fortimo SLM 1216 L23 2828 G6

Mechanical Characteristics

- Fortimo SLM C 730 1216 L23 2828 G6
- Fortimo SLM C 740 1216 L23 2828 G6
- Fortimo SLM C 750 1216 L23 2828 G6
- Fortimo SLM C 757 1216 L23 2828 G6
- Fortimo SLM C 827 1216 L23 2828 G6
- Fortimo SLM C 830 1216 L23 2828 G6
- Fortimo SLM C 835 1216 L23 2828 G6
- Fortimo SLM C 840 1216 L23 2828 G6
- Fortimo SLM C 850 1216 L23 2828 G6
- Fortimo SLM C 857 1216 L23 2828 G6
- Fortimo SLM C 930 1216 L23 2828 G6

Parameter	Min	Typ	Max	Unit
Length	27.8	28	28.2	mm
Width	27.8	28	28.2	mm
Height PCB	0.9	1	1.1	mm
Height including dam	1.2	1.5	1.8	mm

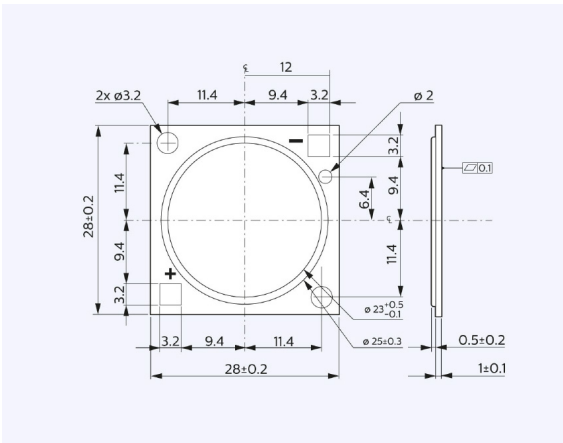

Absolute Ratings

Parameter	Min	Typ	Max	Unit
Current Through the LED Module (I-max)			2400	mA
Case Temperature (Tc-max)			95	°C
Power at Rated Vf-max and I-max			92.6	W
ESD Human Body Model (HBM) Class 3A JESD22-A114-E 8 kV			8	kV
ESD Machine Model (MM) Class B JESD22-A115-B			400	kV
Ambient Temperature	-20		40	°C
Storage Temperature	-40		80	°C

Fortimo SLM 1216 L23 2828 G6

Application Information

Environmental

RoHS/REACH

Certificates and standards

IEC 62031:2008 (First Edition) + A1:2012 + A2:2014

EN 62031:2008 + A1:2013 + A2:2015 without differences

Relevant clauses of IEC 62471:2006 (Incl. IEC/TR 62471-2: 2009 and IEC/TR 62778: 2014)

Relevant clauses of EN 62471:2008 (With IEC/TR 62471-2: 2009 and IEC/TR 62778: 2014)

Relevant clauses of IEC 60838-1:2004 + A1:2008 + A2:2011 with IEC 60838-2-2:2006 + A1:2012

Relevant clauses of EN 60838-1:2004 + A1:2008 + A2:2011 with EN 60838-2-2:2006 + A1:2012

Application	
IP Rating	No IP-rating
Overheating Protection	No
Luminaire Class	IEC Class I and Class II
Dimming	Yes

Warranty Window

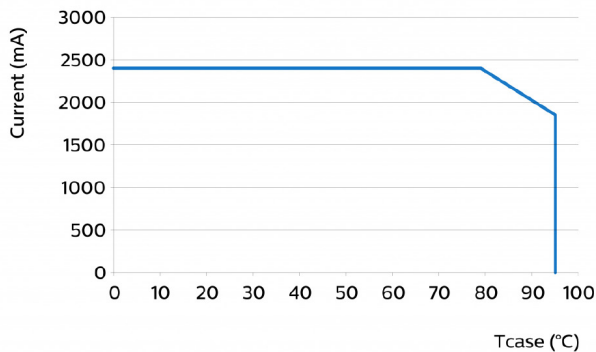

© 2016 Philips Lighting Holding B.V. All rights reserved.
Philips reserves the right to make changes in specifications and/or to discontinue any product at any time without notice or obligation and will not be liable for any consequences resulting from the use of this publication.
philips.com/ledmodulesna



Philips Lighting North America Corporation
10275 W. Higgins Road, Rosemont IL 60018
Tel: 800-322-2086 Fax: 888-423-1882
Customer/Technical Service: 800-372-3331
OEM Support: 866-915-5886

Philips Lighting Canada Ltd.
281 Hillmount Rd, Markham, ON, Canada L6C 2S3
Tel. 800-668-9008