

PHILIPS

LED Modules

Fortimo SLM Premium White

1202 L06 1215 G6



Philips Fortimo LED spotlight module (SLM) premium white gen 6 continues to focus on the combination of quality of light and performance. By offering the CoB separate from the holder, even more flexibility in possible system combinations and specifications is achieved. This results in an extensive portfolio of lumen ranges, CCTs and spectra. Please also check the online Easy Design-in Tool for your perfect system combination (www.na.easydesignintool.philips.com).

Ordering Data

Commercial Product Name	12NC	Minimum Order Quantity
Fortimo SLM C 830 PW 1202 L06 1215 G6	9290 014 53906	20
Fortimo SLM C 930 PW 1202 L06 1215 G6	9290 014 54006	20
Fortimo SLM C 935 PW 1202 L06 1215 G6	9290 014 54106	20
Fortimo SLM C 940 PW 1202 L06 1215 G6	9290 014 54206	20

Not all products are currently available as make-to-stock. Please contact your local Philips representative for specific availability and lead time.

Fortimo SLM premium white 1202 L06 1215 G6

Features

- Excellent quality of light available for all applications
- Extensive range of CCT
- Small LES for narrow beam angles and small reflector designs
- Flexibility to select a different lumen output between 800 lm and 10000 lm
- State-of-the-art chip-on-board (CoB) technology, enabling high system efficacy
- System proposition (CoB + holder + driver)

- Flexibility to optimize luminaire performance (lm/W or high lumen output)
- Philips Advance Xitanium LED window drivers with SimpleSet technology for maximum flexibility
- Mini drivers for smallest possible luminaire designs
- Three dedicated product lines:
 - SLM gen 6 premium white
 - SLM gen 6 crisp white
 - SLM gen 6 food

Benefits

- 5-year limited system warranty with over 50,000 hours lifetime¹

Applications

- Architectural lighting
- Retail spot lighting
- Recessed downlight

Drive Currents

Parameter	Nominal*	Life**	Max***	Unit
Fortimo LED SLM PW 1203 L9 1619 G6	200	280	340	mA

Module Temperatures

Parameter	Nominal*	Life**	Max***	Unit
Tc (case temperature at Tc point)	85	85	95	°C

* Nominal value at which typical performance is specified

** Value at which life time is specified

*** Maximum value for safe operation, do not operate above this value

1. View limited warranty at <http://www.usa.lighting.philips.com/support/support/warranty> for details and restrictions.

Fortimo SLM premium white 1202 L06 1215 G6

Optical Characteristics – Table per CCT

Fortimo SLM C 830 PW 1202 L06 1215 G6				
Parameter	Min	Typ	Max	Unit
Luminous Flux	800	880	970	lm
Module Efficiency		128		lm/W
Correlated Color Temperature (CCT)		3000		K
Color Coordinates (CIEx, CIEy)		(0.422, 0.386)		–
Color Consistency			3	SDCM
CRI	80	82		–

Measurement tolerances are: ±5% on flux, ±6% on efficiency, +0.005 on x,y, and ±1.5 on CRI.

Measurement precision for flux +/- 5%.
Measurement precision for efficacy +/- 6%.
Measurement precision for x, y +/- 0.005.
Measurement precision for CRI +/- 1.5.

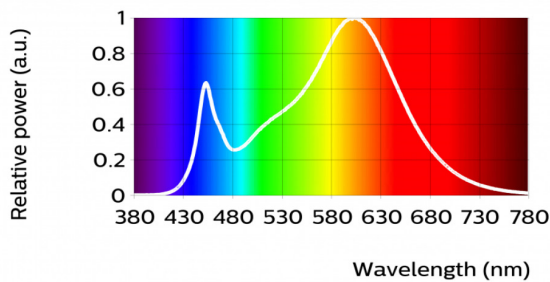

R1	R2	R3	R4	R5	R6	R7	R8	R9	R10	R11	R12	R13	R14	R15
83	95	92	80	84	93	80	58	10	88	79	79	86	96	

Fortimo SLM C 930 PW 1202 L06 1215 G6				
Parameter	Min	Typ	Max	Unit
Luminous Flux	670	750	820	lm
Module Efficiency		108		lm/W
Correlated Color Temperature (CCT)		3000		K
Color Coordinates (CIEx, CIEy)		(0.422, 0.386)		–
Color Consistency			3	SDCM
CRI	90	92		–

Measurement tolerances are: ±5% on flux, ±6% on efficiency, +0.005 on x,y, and ±1.5 on CRI.

Measurement precision for flux +/- 5%.
Measurement precision for efficacy +/- 6%.
Measurement precision for x, y +/- 0.005.
Measurement precision for CRI +/- 1.5.

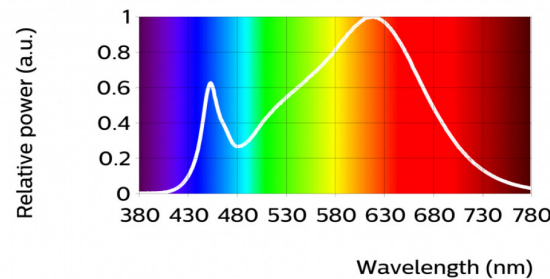

R1	R2	R3	R4	R5	R6	R7	R8	R9	R10	R11	R12	R13	R14	R15
93	97	97	91	93	95	90	80	58	93	91	83	95	99	

Fortimo SLM premium white 1202 L06 1215 G6

Optical Characteristics – Table per CCT

Fortimo SLM C 935 PW 1202 L06 1215 G6

Parameter	Min	Typ	Max	Unit
Luminous Flux	710	790	860	lm
Module Efficiency		114		lm/W
Correlated Color Temperature (CCT)		3500		K
Color Coordinates (CIEx, CIEy)		(0.398, 0.376)		–
Color Consistency			3	SDCM
CRI	90	92		–

Measurement tolerances are: ±5% on flux, ±6% on efficiency, +0.005 on x,y, and ±1.5 on CRI.

Measurement precision for flux +/- 5%.
Measurement precision for efficacy +/- 6%.
Measurement precision for x, y +/- 0.005.
Measurement precision for CRI +/- 1.5.

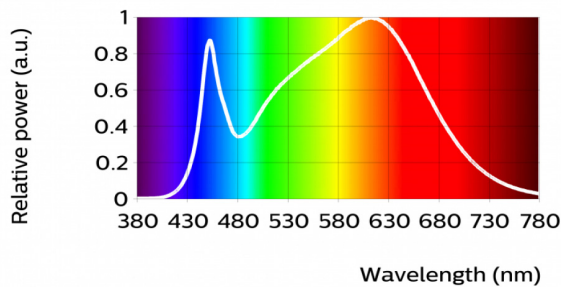

R1	R2	R3	R4	R5	R6	R7	R8	R9	R10	R11	R12	R13	R14	R15
93	96	97	91	92	93	92	82	59	89	91	77	94	98	

Fortimo SLM C 940 PW 1202 L06 1215 G6

Parameter	Min	Typ	Max	Unit
Luminous Flux	720	800	880	lm
Module Efficiency		117		lm/W
Correlated Color Temperature (CCT)		4000		K
Color Coordinates (CIEx, CIEy)		(0.374, 0.364)		–
Color Consistency			3	SDCM
CRI	90	92		–

Measurement tolerances are: ±5% on flux, ±6% on efficiency, +0.005 on x,y, and ±1.5 on CRI.

Measurement precision for flux +/- 5%.
Measurement precision for efficacy +/- 6%.
Measurement precision for x, y +/- 0.005.
Measurement precision for CRI +/- 1.5.

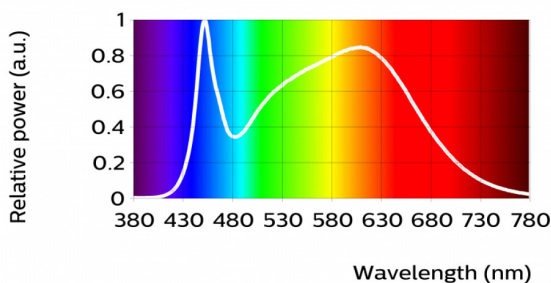

R1	R2	R3	R4	R5	R6	R7	R8	R9	R10	R11	R12	R13	R14	R15
92	96	96	91	92	92	92	83	60	88	90	72	94	97	

Fortimo SLM premium white 1202 L06 1215 G6

Beam Shape

Bare CoB

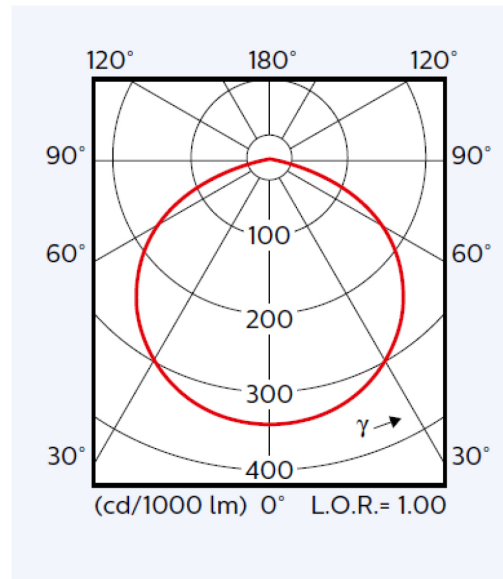

CoB with a poke-in holder

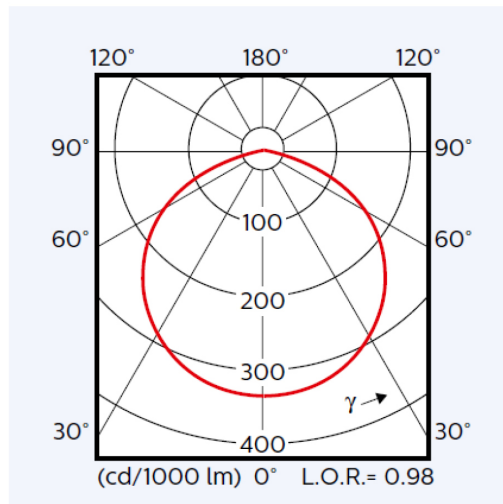

Fortimo SLM premium white 1202 L06 1215 G6

Fortimo SLM C 830 PW 1202 L06 1215 G6

Fortimo SLM C 930 PW 1202 L06 1215 G6

Fortimo SLM C 935 PW 1202 L06 1215 G6

Fortimo SLM C 940 PW 1202 L06 1215 G6

Parameter	Min	Typ	Max	Unit
Forward Voltage		34.4	36.9	V
Power Consumption		6.9	7.4	W
Thermal Power		4.3		W

Measurement precision for Vf +/- 3%. Measurement precision for power +/- 3.3%.

Tuning Information

Flux and efficacy vs. current (at Tc nominal)

I [mA]	Flux [%]	Efficacy [%]
100	55	115
130	69	110
160	83	106
200	100	100
280	131	90
300	138	88
320	145	86
340	152	84

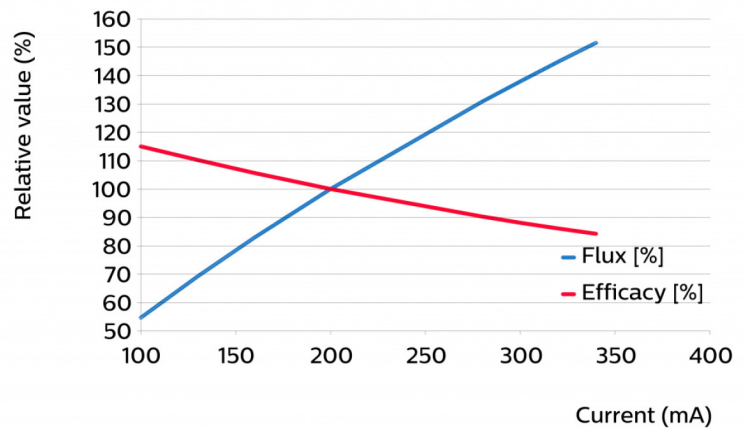

Flux and efficacy vs. temperature at Tc (at I nominal)

Tcase [°C]	Flux [%]	Efficacy [%]
55	108	106
65	105	104
75	103	102
85	100	100
95	97	98

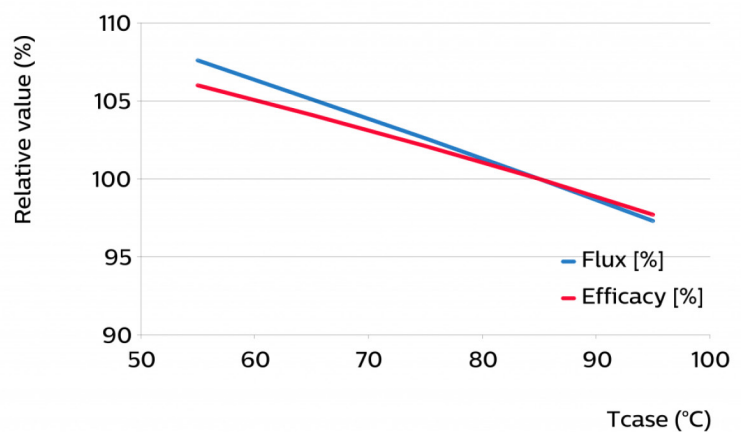

Fortimo SLM premium white 1202 L06 1215 G6

Lumen Maintenance

Lumen maintenance at I-life and Tc-life conditions

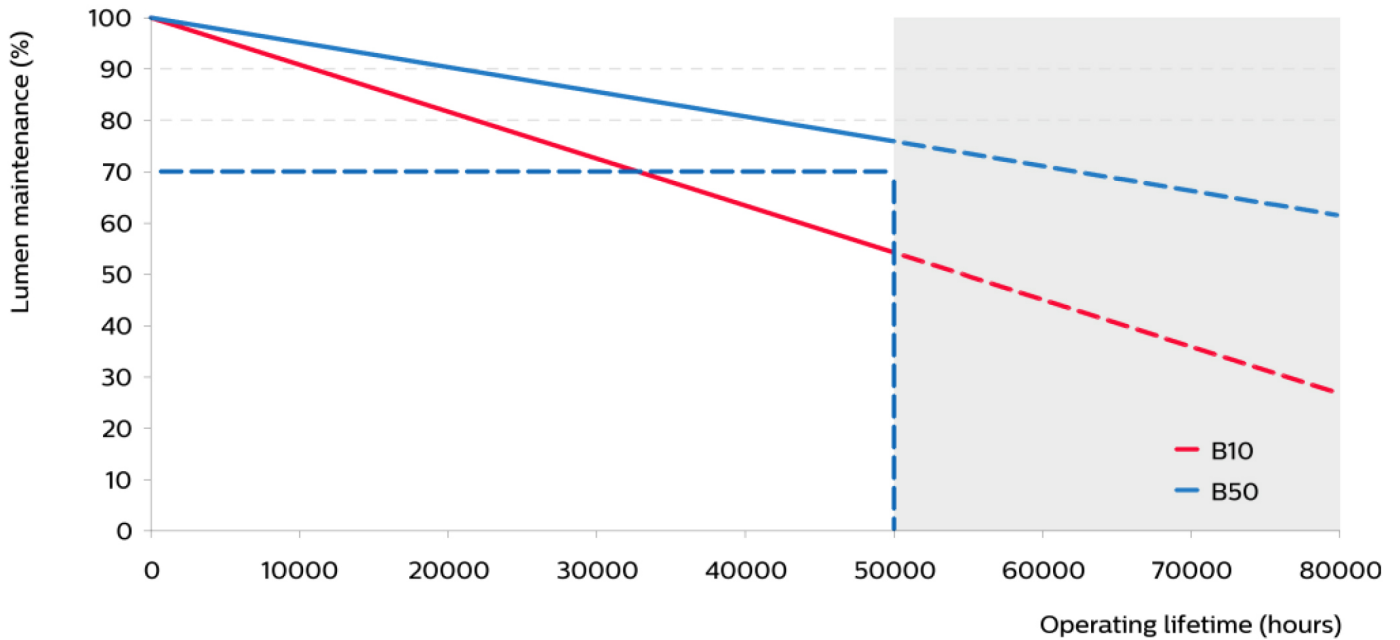

Lumen maintenance for B50 at current I-life conditions

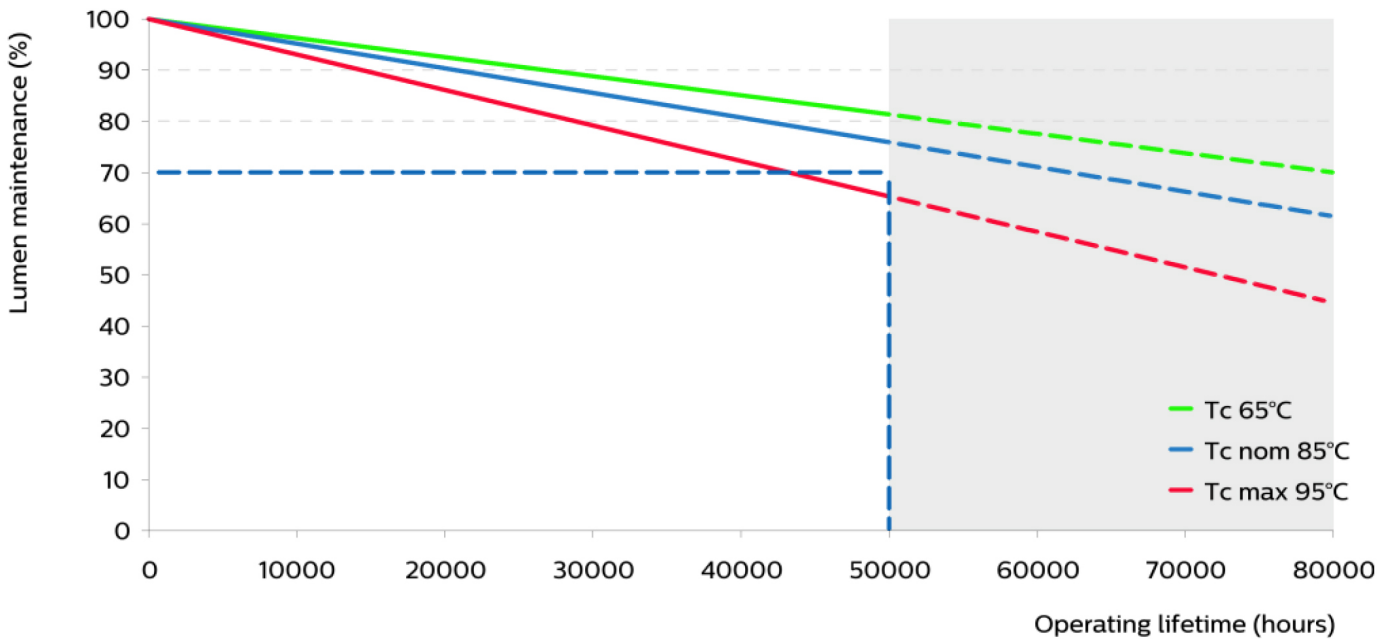

Fortimo SLM premium white 1202 L06 1215 G6

Mechanical Characteristics

Parameter	Min	Typ	Max	Unit
Length	14.8	15	15.2	mm
Width	11.8	12	12.2	mm
Height PCB	0.9	1	1.1	mm
Height including dam	1.2	1.5	1.8	mm

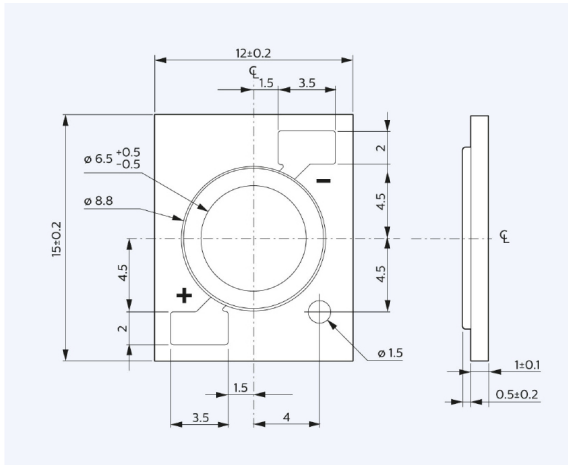

Absolute Ratings

Parameter	Min	Typ	Max	Unit
Current Through the LED Module (I-max)			340	mA
Case Temperature (Tc-max)			95	°C
Power at Rated Vf-max and I-max			13.3	W
ESD Human Body Model (HBM) Class 3A JESD22-A114-E 8 kV			8	kV
ESD Machine Model (MM) Class B JESD22-A115-B			400	kV
Ambient Temperature	-20		40	°C
Storage Temperature	-40		80	°C

Fortimo SLM premium white 1202 L06 1215 G6

Application Information

Environmental

RoHS/REACH

Certificates and standards

IEC 62031:2008 (First Edition) + A1:2012 + A2:2014

EN 62031:2008 + A1:2013 + A2:2015 without differences

Relevant clauses of IEC 62471:2006 (Incl. IEC/TR 62471-2: 2009 and IEC/TR 62778: 2014)

Relevant clauses of EN 62471:2008 (With IEC/TR 62471-2: 2009 and IEC/TR 62778: 2014)

Relevant clauses of IEC 60838-1:2004 + A1:2008 + A2:2011 with IEC 60838-2-2:2006 + A1:2012

Relevant clauses of EN 60838-1:2004 + A1:2008 + A2:2011 with EN 60838-2-2:2006 + A1:2012

Application	
IP Rating	No IP-rating
Overheating Protection	No
Luminaire Class	IEC Class I and Class II
Dimming	Yes

Warranty Window

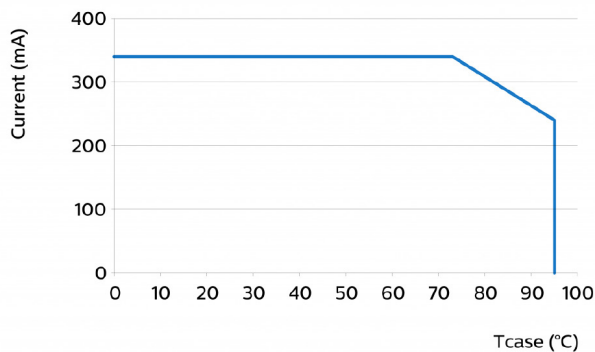

© 2016 Philips Lighting Holding B.V. All rights reserved.
Philips reserves the right to make changes in specifications and/or to discontinue any product at any time without notice or obligation and will not be liable for any consequences resulting from the use of this publication.
philips.com/ledmodulesna



Philips Lighting North America Corporation
10275 W. Higgins Road, Rosemont IL 60018
Tel: 800-322-2086 Fax: 888-423-1882
Customer/Technical Service: 800-372-3331
OEM Support: 866-915-5886

Philips Lighting Canada Ltd.
281 Hillmount Rd, Markham, ON, Canada L6C 2S3
Tel. 800-668-9008