

**PHILIPS
ADVANCE**

LED Driver

Xitanium

72W 120-277V 3.0A 0-10V
XI072C300V024CNS1



**RoHS
COMPLIANT**



Intertek
Class P
Conforms to UL STD 8750
Certified to CAN/CSA STD
C22.2 No. 250.13

Class P
LED class 2 output
For Dry and Damp Location

The Philips Advance Xitanium portfolio provides high-performance and reliable driver solutions for lighting applications. The Xitanium LED drivers with both constant voltage (CV) and constant current (CC) mode are compatible with respective loads and allow the user to utilize the same driver for CV and CC applications. The drivers provide general illumination for outdoor applications, including LED signs and canopy lights. They can also be used in indoor CV applications such as strip and bar lights or under-cabinet lighting, ambient lighting and low-bay and high-bay industrial lighting.

Specifications

Input Voltage (Vac)	Output Power (W)	Output Voltage (V)	Output Current (A)	Efficiency@ Max. Load and 75°C Case	Max. Case Temp. (°C)	Input Current (A)	Max. Input Power (W)	THD @ Max. Load (%)	Power Factor @ Max. Load	Surge Protection (Combi-Wave, KV)	Envir. Protection Rating
120	72	12-24 CC Mode	3.0	87	85°C	0.7	85	<10%	>0.95	4	UL damp & dry and Type HL
277				88		0.3					

Enclosure

	In. (mm)
Case Length (L2)	8.34 (211.7)
Case Width (W)	1.70 (43.1)
Case Height (H)	1.12 (28.5)
Mounting Length (M)	8.89 (225.8)
Overall Length (L1)	9.45 (240)

Wiring Diagram

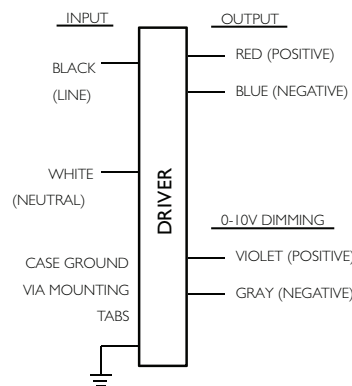

Dimming	Dimming Range (with specified dimmers)	Minimum Output Current (A)
0-10V Analog Class 1 and 2 Wiring	10% ~ 100%	0.3

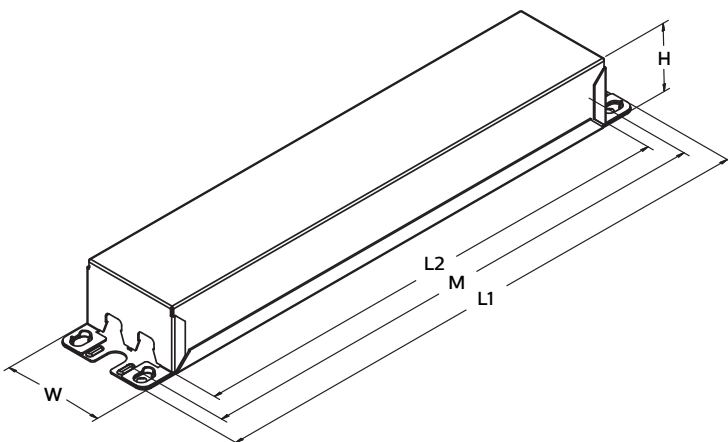

Xitanium 72W 3.0A 0-10V dimming

Features

- 50,000+ hour lifetime¹
- Excellent thermal performance
- Can be used in constant current (CC) or constant voltage (CV) mode²

Benefits

- Enables long life luminaire designs
- Allows luminaire designs for a wide range of ambient environments

Application

- Area
- Roadway
- Ambient, bar and strip lights
- Exterior and canopy lighting

Electrical Specifications

All the specifications are typical and at 25°C Tcase unless specified otherwise.

Product Data

Order Information	
Full Product Code	XI072C300V024CNS1M (Mid-Pack, 20pcs/Box) 12NC: 929001708013
Line Frequency	50/60Hz
Min. Mains Voltage Operational	108 Vac
Max. Mains Voltage Operational	305 Vac
Output Information	
Maximum Open Circuit Voltage	24Vdc
Output Current Ripple (in CC mode) (ripple = peak to average / average)	15% max. @ max. Iout Low frequency (≤ 120 Hz) content <5%
Output Current Tolerance (at maximum output current)	<5%
CV Mode Load Type	Active CV loads not recommended
CV Mode Load Range	0.1 - 3.0Adc
Protections	Short Circuit, Open Circuit Protection for LED + and LED – and Temperature Foldback
Features	
0-10V Dimming ³	150 μ A ($\pm 3\%$) source current from driver. See dim curve for detail.
Environment & Approbation	
Operating Ambient Temp. Range	-40°C to +55°C
Max. Case Temperature (Tcase)	85°C
Agency Approbations	UL 8750, CSA 250.13 Class P
Electromagnetic Compliance	FCC Title 47 Part 15 Class A
Audible Noise	<24dB Class A
Weight	1.4 Lbs / 0.63 kgs

1. Philips Advance Xitanium LED drivers are manufactured to engineering standards correlating to a designed and average life expectancy of 50,000 hours of operation at maximum rated case temperature. Minimum 90% survivals based on MTTF modeling.
2. For active constant voltage (CV) loads, operation with desired CV loads must be verified for the load range specified in the end application.
3. 0-10V dimming only applicable in constant current (CC) mode.

Xitanium 72W 3.0A 0-10V dimming

Electrical Specifications

All the specifications are typical and at 25°C Tcase unless specified otherwise.

0-10V Dimming Curve

Dimming source current from the driver: 150µA (@ 0<Vdim<8V)

Minimum dim level: Factory default 10% of Iout

Maximum output voltage on the dimming wires: 12V

0-10V dimming is applicable in CC mode only. Max voltage of load at the output of the driver should be less than 23.5V to be in CC mode.

Approved Dimmer List

Manufacturer	Manufacturer Part Number
Lutron	Visit www.lutron.com/advance for a list of dimmers (Mark VII) that will work with this driver
Leviton	IllumaTech IP7 series
Philips	Sunrise - SR1200ZTUNV

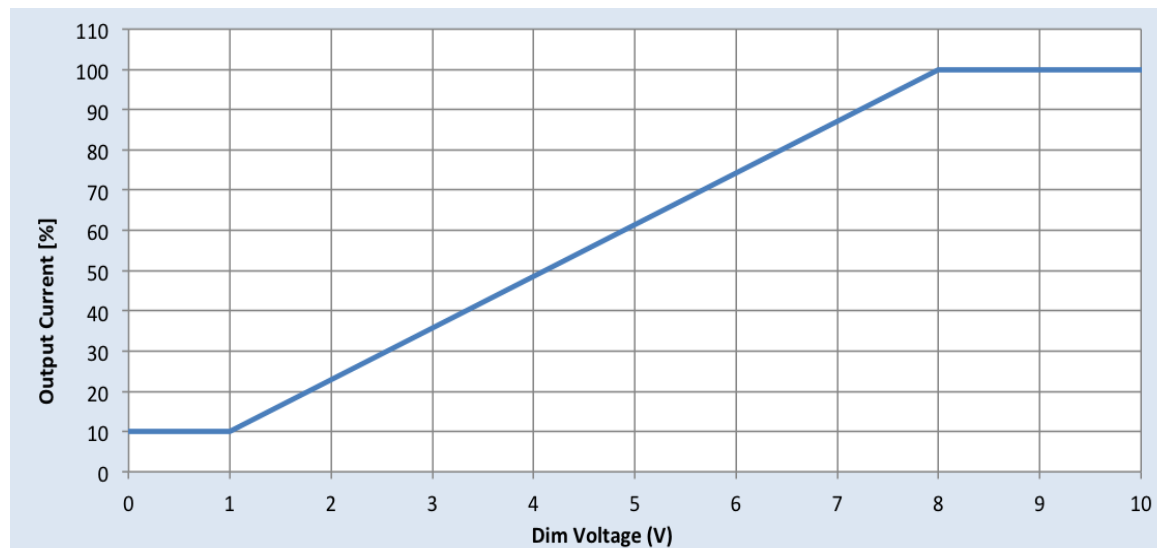

Xitanium 72W 3.0A 0-10V dimming

Electrical Specifications

All the specifications are typical and at 25°C Tcase unless specified otherwise.

Output Current Vs. Driver Case Temperature

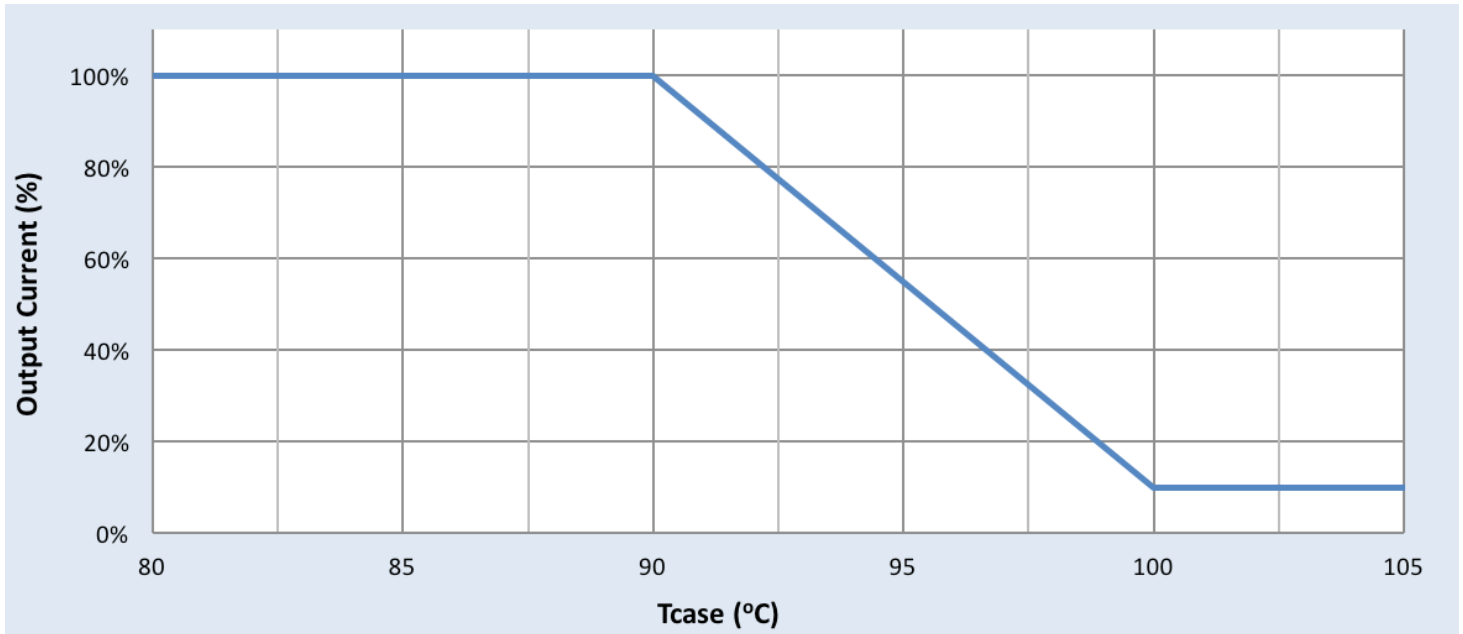

Note

There is $\pm 5^\circ\text{C}$ tolerance on the driver case temperature.

Driver Lifetime Vs. Driver Case Temperature

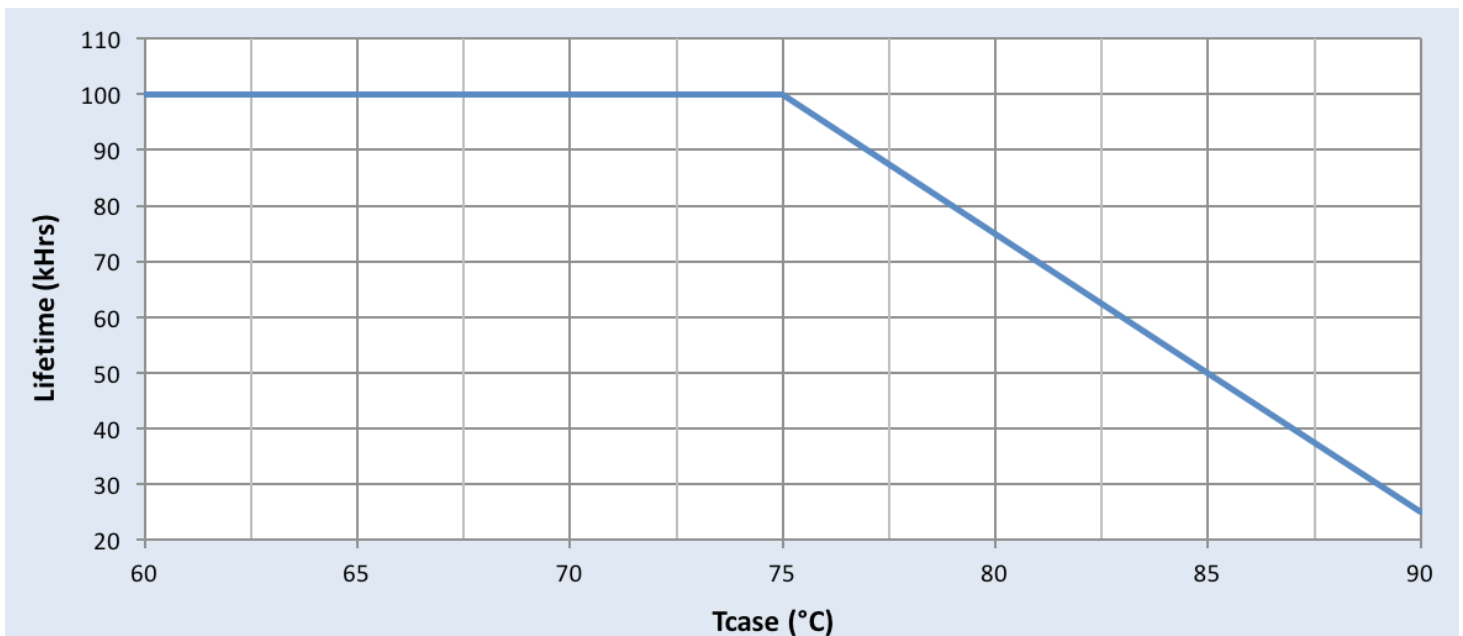

Xitanium 72W 3.0A 0-10V dimming

Performance Characteristics

Based on measurements on a typical sample at 75°C case. The accuracy of the measurements is within the tolerance of the measurement instruments.

Efficiency Vs. Output Voltage

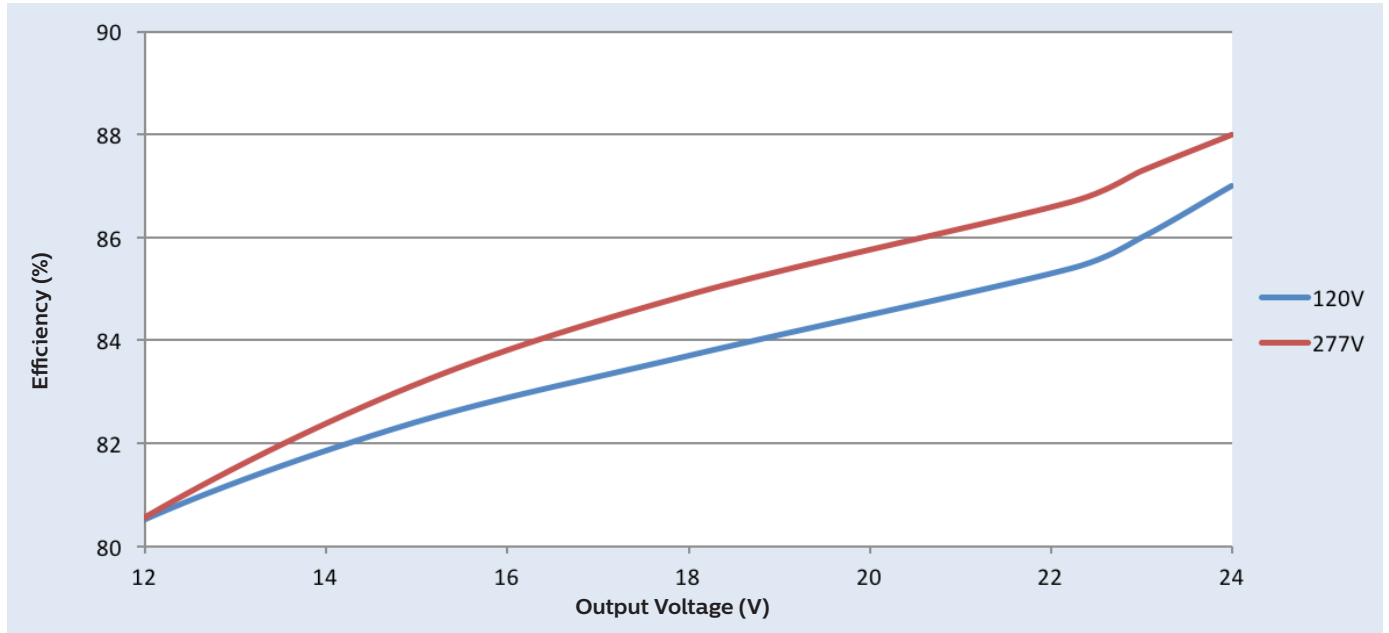

Xitanium 72W 3.0A 0-10V dimming

Performance Characteristics

Based on measurements on a typical sample at 75°C case. The accuracy of the measurements is within the tolerance of the measurement instruments.

Power Factor Vs. Output Power

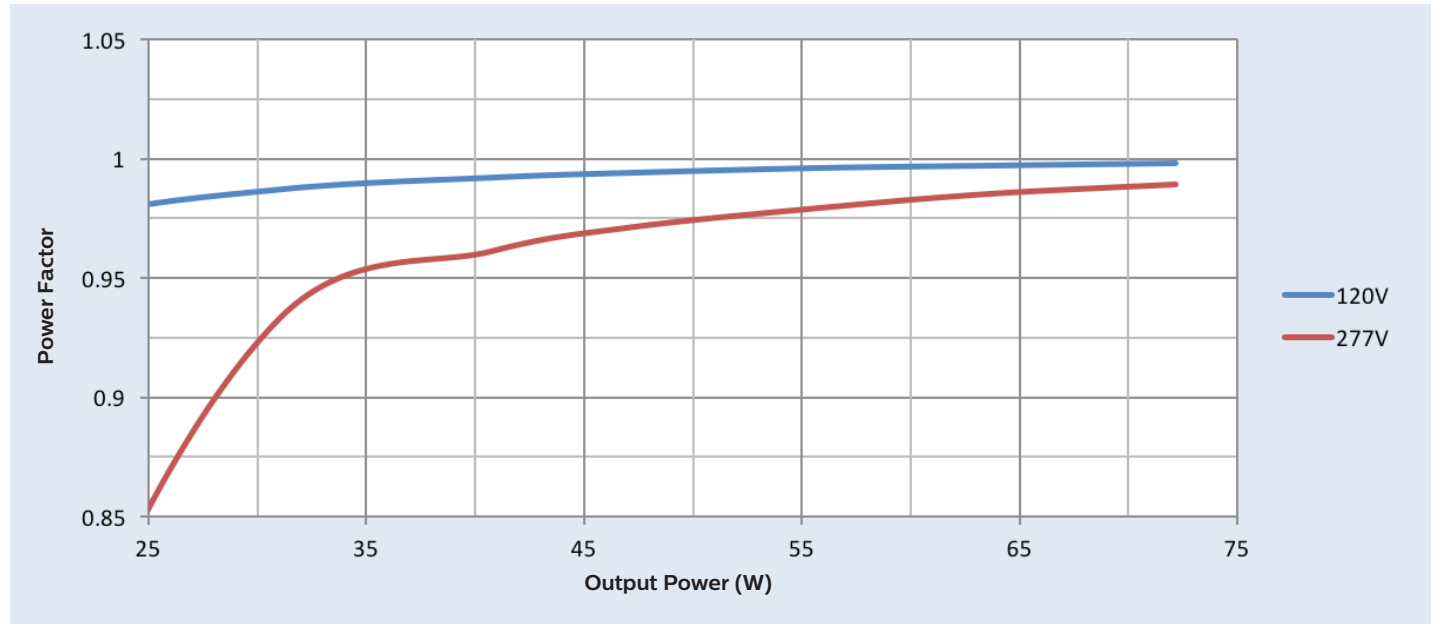

Total Harmonic Distortion (THD) Vs. Output Power

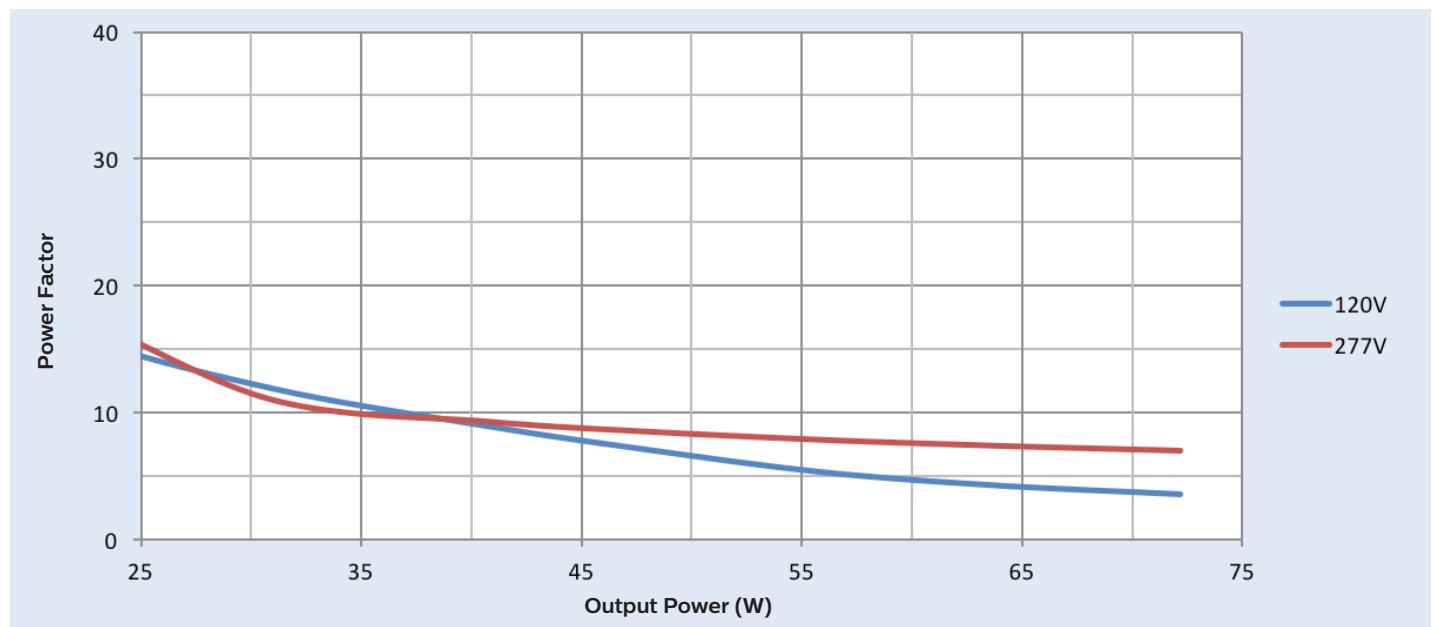

Xitanium 72W 3.0A 0-10V dimming

Inrush Current Info

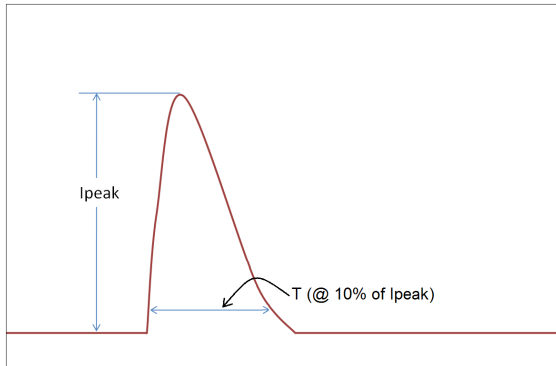

Vin	Ipeak	T (@ 10% of Ipeak)
120 Vrms	27.7A	187.5μS
277 Vrms	87A	178μS

Inrush current is measured at peak of the corresponding line voltage. Source impedance per NEMA 410.

Lightning Surge Info

ANSI Surge Type	Differential Mode (L-N)	Common Mode (L-G, N-G, L&N-G)
1.2/50μs Combination Wave (w/t 2Ω)	4kV	4kV

Isolation

Isolation	Input	Output	0-10V	Enclosure
Input	NA	2xU+1kV	2.5kV	2xU+1kV
Output	2xU+1kV	NA	2.5kV	500
0-10V	2.5kV	2.5kV	NA	2xU+1kV
Enclosure	2xU+1kV	500	2xU+1kV	NA

U = Max. input voltage

© 2017 Koninklijke Philips N.V. All rights reserved.
Philips reserves the right to make changes in specifications and/or to discontinue any product at any time without notice or obligation and will not be liable for any consequences resulting from the use of this publication.
philips.com/leddrivers



Philips Lighting North America Corporation
10275 W. Higgins Road, Rosemont IL 60018
Tel: 800-322-2086 Fax: 888-423-1882
Customer/Technical Service: 800-372-3331
OEM Support: 866-915-5886

Philips Lighting Canada Ltd.
281 Hillmount Rd, Markham, ON, Canada L6C 2S3
Tel. 800-668-9008