

# PHILIPS

## LED Modules

Fortimo LLS  
EaseSelect

4ft 4400lm 1R LV1  
36W INT and  
36W 0-10V INT



The Philips Fortimo linear lighting system (LLS) EaseSelect (ES) is an linear integrated LED light engine solution that combines a 36W UL Class 2 constant current LED driver and a 4ft long L2 LED module into a fully optimized system.

The system is available with two types of drivers: a non-dimmable driver and an 0-10V dimmable driver

It enables OEM fixture manufacturers to design and manufacture 4ft long LED fixtures meeting minimum DLC requirements optimized for cost efficiency. Its patented system design provides opportunity to reduce\* mechanical and electrical fixture bill of materials while delivering high quality of light and performance.

With the application of commercial LED strip and waterproof fixtures in mind, Philips has designed this economic system solution to provide added value to designers.

### Ordering Data

Commercial Product Name – Modules	12NC	Minimum Order Quantity
Fortimo LLS ES 4ft 4400lm 830 1R LV1	929000760813	96
Fortimo LLS ES 4ft 4400lm 835 1R LV1	929000760913	96
Fortimo LLS ES 4ft 4400lm 840 1R LV1	929000761013	96
Fortimo LLS ES 4ft 4400lm 850 1R LV1	929000771313	96

Commercial Product Name – Drivers	Dimming	12NC	Minimum Order Quantity
Fortimo LLS ES 36W INT LV1	Fixed	929000761113	96
Fortimo LLS ES 36W INT 0-10V LV1	0-10V dimmable	929000761213	96

\* Reduced compared to usage of conventional LED components with separate LED modules and LED drivers.

# Fortimo LLS ES 4ft 4400lm 1R LV1 36W INT and 36W 0-10V INT

## Features

- 4ft LED light engine with optimized Class 2 LED driver on board
- 4400lm light output
- CRI80, 3 SDCM
- 120 lm/W system efficacy
- Plug-and-play snap-on assembly
- UL Recognized (UL8750)

## Benefits

- Easy to design-in
- Cost efficient
- Meets performance specifications for standard DLC<sup>1</sup>
- High quality of light
- Enables flexible supply chain

## Applications

- 4ft LED strip lights
- 4ft LED waterproof and explosion-proof luminaires

## Key System Specifications<sup>2</sup>

**Fortimo LLS ES 4ft 4400lm 830 1R LV1 36W INT & Fortimo LLS ES 4ft 4400lm 830 1R LV1 36W INT 0-10V**

Parameter	Min	Typ	Max	Unit
Electrical Power		34	38	W
Luminous Flux		4010		lm
Lumen Efficacy (System)		115		lm/W
Correlated Color Temperature (CCT)		3000		K
CRI	80			-
Radiation Angle		120		deg
Color Consistency			3	SDCM
Light Output @ 50,000 Hours	L70			-
$\Delta u'v'$ at 6000 Hours			0.007	$\Delta u'v'$

Electrical Operation Point	$T_c$ <sup>3</sup>	Luminous Flux [lm]	System Efficacy [lm/W]
Operated at 120VAC/277VAC	$T_c$ 1 25°C	4293	123
	$T_c$ 1-nom 65°C	4010	115
	$T_c$ 1-life 80°C	3882	114

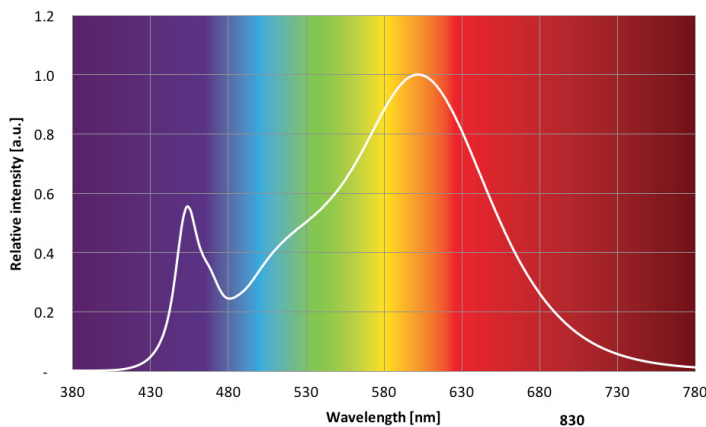

1. Fortimo LLS EaseSelect is not a DLC qualified product. It is an OEM component that meets certain performance specifications that are geared toward meeting DLC Standard Tier (v4.2) in a fully assembled fixture. The customer is liable for proper design, manufacturing, testing and qualification according to DLC requirements.
2. Performance specifications noted on system level (incl. driver losses). Based on Tcase, nominal tolerance for flux and efficacy, data on system level is +/- 15%. Philips maintains a tester tolerance of +/-5% on flux, +/-0.005 on color, +/- 1.5 on CRI, +/- 3% on Vf, +/- 3.3% on power and +/-6% on efficacy.
3.  $T_c$ 1 is the  $T_c$  of the LED Module.

# Fortimo LLS ES 4ft 4400lm 1R LV1 36W INT and 36W 0-10V INT

## Key System Specifications<sup>2</sup>

**Fortimo LLS ES 4ft 4400lm 835 1R LV1 36W INT & Fortimo LLS ES 4ft 4400lm 835 1R LV1 36W INT 0-10V**

Parameter	Min	Typ	Max	Unit
Electrical Power		34	38	W
Luminous Flux		4227		lm
Lumen Efficacy (System)		121		lm/W
Correlated Color Temperature (CCT)		3500		K
CRI	80			–
Radiation Angle		120		deg
Color Consistency			3	SDCM
Light Output @ 50,000 Hours	L70			–
$\Delta u'v'$ at 6000 Hours			0.007	$\Delta u'v'$

Electrical Operation Point	T <sub>c</sub> 1	Luminous Flux [lm]	System Efficacy [lm/W]
Operated at 120VAC/277VAC	T <sub>c</sub> 1 25°C	4534	129
	T <sub>c</sub> 1-nom 65°C	4227	121
	T <sub>c</sub> 1-life 80°C	4092	120

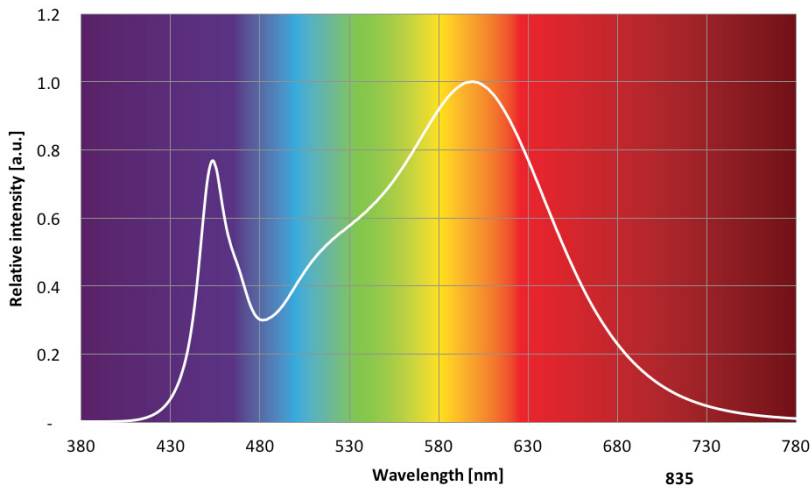

See page 2 for footnote.

# Fortimo LLS ES 4ft 4400lm 1R LV1 36W INT and 36W 0-10V INT

## Key System Specifications<sup>2</sup>

**Fortimo LLS ES 4ft 4400lm 840 1R LV1 36W INT & Fortimo LLS ES 4ft 4400lm 840 1R LV1 36W INT 0-10V**

Parameter	Min	Typ	Max	Unit
Electrical Power		34	38	W
Luminous Flux		4400		lm
Lumen Efficacy (System)		123		lm/W
Correlated Color Temperature (CCT)		4000		K
CRI	80			–
Radiation Angle		120		deg
Color Consistency			3	SDCM
Light Output @ 50,000 Hours	L70			–
$\Delta u'v'$ at 6000 Hours			0.007	$\Delta u'v'$

Electrical Operation Point	T <sub>c</sub> 1	Luminous Flux [lm]	System Efficacy [lm/W]
Operated at 120VAC/277VAC	T <sub>c</sub> 1 25°C	4641	131
	T <sub>c</sub> 1-nom 65°C	4400	123
	T <sub>c</sub> 1-life 80°C	4261	122

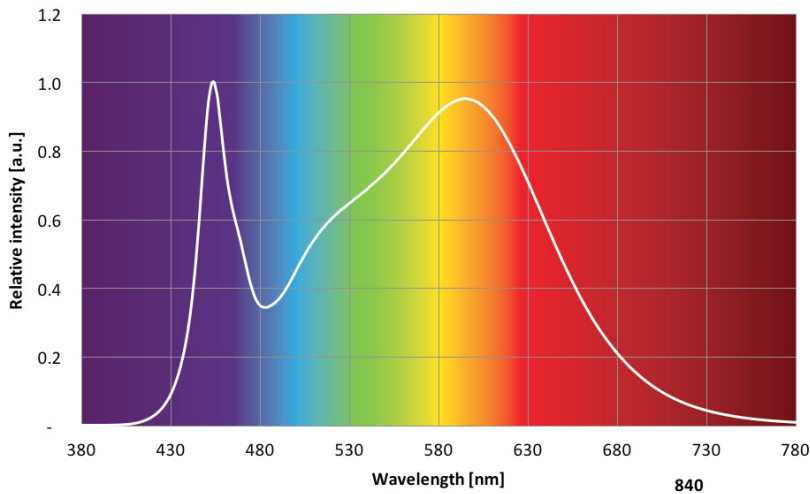

See page 2 for footnote.

# Fortimo LLS ES 4ft 4400lm 1R LV1 36W INT and 36W 0-10V INT

## Key System Specifications<sup>2</sup>

**Fortimo LLS ES 4ft 4400lm 850 1R LV1 36W INT & Fortimo LLS ES 4ft 4400lm 850 1R LV1 36W INT 0-10V**

Parameter	Min	Typ	Max	Unit
Electrical Power		34	38	W
Luminous Flux		4400		lm
Lumen Efficacy (System)		123		lm/W
Correlated Color Temperature (CCT)		5000		K
CRI	80			–
Radiation Angle		120		deg
Color Consistency			3	SDCM
Light Output @ 50,000 Hours	L70			–
$\Delta u'v'$ at 6000 Hours			0.007	$\Delta u'v'$

Electrical Operation Point	T <sub>c</sub> 1	Luminous Flux [lm]	System Efficacy [lm/W]
Operated at 120VAC/277VAC	T <sub>c</sub> 1 25°C	4641	131
	T <sub>c</sub> 1-nom 65°C	4400	123
	T <sub>c</sub> 1-life 80°C	4261	122

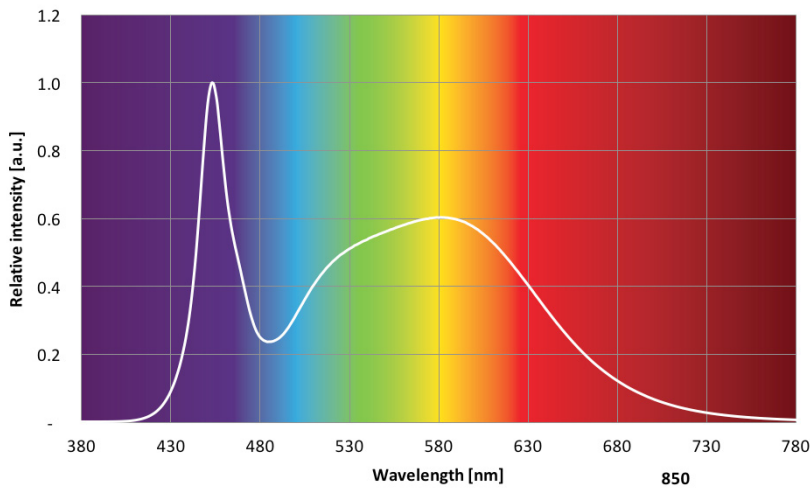

See page 2 for footnote.

# Fortimo LLS ES 4ft 4400lm 1R LV1 36W INT and 36W 0-10V INT

## Beam Shape

The Philips Fortimo LLS ES generates a lambertian beam shape, which is a pragmatic starting point for OEMs wishing to design secondary optics.

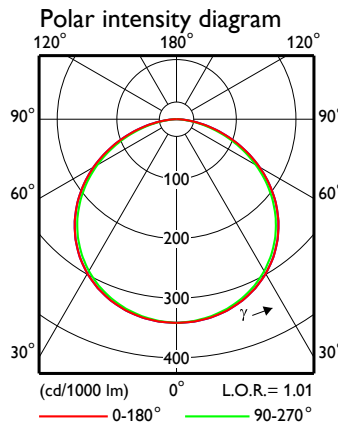

## Product Ratings and Case Temperatures

Parameter	Nominal*	Life**	Max***	Unit
Tcase 1, LED module	65	80	85	°C
Tcase 2, LED driver – Fixed	NA	85	90	°C
Tcase 2, LED driver – 0-10V	NA	85	85	°C

Parameter	Reference	Lifetime	Unit
Lumen Maintenance L70	Tcase 1, LED module	>50	kHrs
Product Lifetime (C10)	Tcase 2, LED driver	>50	kHrs

\* Nominal value at which typical performance is specified

\*\* Value at which lifetime is specified

\*\*\* Maximum value for safe operation, do not operate above this value

**Warranted number of full thermal product cycles at which the survival rate of the population  $\geq 90\%$ , at 25 °C ambient temperature**

Case Temperature Tc2 [°C]	Amount of Cycles
35	
40	
45	33,000
50	
55	23,000
60	
65	17,000
70	15,000
75	14,000
80	12,000
85	11,000

# Fortimo LLS ES 4ft 4400lm 1R LV1 36W INT and 36W 0-10V INT

## Electrical Specifications of LED Driver

Specifications Type	Unit	Fortimo LLS ES 36W INT LV1			Fortimo LLS ES 36W INT 0-10V LV1		
		Min	Typ	Max	Min	Typ	Max
AC Input Voltage	Vin [Vac]	120		277	120		277
Mains Frequency	f [Hz]		60			60	
Power Factor	PF	0.9			0.9		
Total Harmonic Distortion	THD [%]			20			20
Surge (ring wave), DM & CM	kV	2.5			2.5		
Audible Noise Level	dB (A)			20			20
Output Safety Level		UL Class 2			UL Class 2		
Dimming Interface		Non-dimmable			0-10V		
Inrush Current $I_{peak}$	$A_{peak}$	14A @ 120V 42A @ 277V			13A @ 120V 33A @ 277V		
Inrush Current $T_{width}$	$\mu$ s	5			10		
Inrush Current		NEMA 410			NEMA 410		

## Additional Specifications of LED System

Specifications Type	Unit	Fortimo LLS ES 4ft 4400lm 1R LV1 36W INT	Dimmer Driver (PLEASE PROVIDE CORRECT DRIVER NAME)
Percent Flicker	%	< 30	< 30
Flicker Index	FI	< 0.1	< 0.1
Stroboscopic Visibility Measure	SVM	<1	<1
ESD Protection	kV	8	8
Min Ambient Operating Temperature	°C	-20 <sup>4</sup>	-20 <sup>4</sup>
EMI		FCC47, Part 15, class A limits	FCC47, Part 15, class A limits

4. There cannot be any ice/fog/mist on any part of the L2 surface during the application at -20°C.

# Fortimo LLS ES 4ft 4400lm 1R LV1 36W INT and 36W 0-10V INT

## Wiring

### Mains Connector of LED Driver (Mains Input)

Specifications Item	Value	Unit	Condition
Input Wire Cross-Section	0.2 – 1.5	mm <sup>2</sup>	solid
	18 - 16	AWG	
	0.25 - 1	mm <sup>2</sup>	stranded
	18 - 17	AWG	
Input Wire Strip Length	8 - 9	mm	

### LED Driver to LED Module Connection

Specifications Item	Value	Unit	Condition
Class 2 Output Wire Length	120	mm	
Wire Strip Length	9	mm	± 0.5 (twisted and tinned at both sides)
Voltage Rating	600	V	
Temperature Rating	105	°C	

### LED Driver to Dimming Wires Connection

Specifications Item	Value	Unit	Condition
Dimming Wire Length	320	mm	
Wire Strip Length	9	mm	± 0.5 (twisted and tinned at both sides)
Voltage Rating	600	V	
Temperature Rating	105	°C	
	0.75	mm <sup>2</sup>	stranded
	20	AWG	

### Wiring Diagram LED Driver

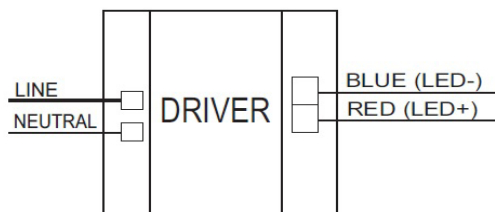

Terminal Color – Fixed Driver	Value
White	Neutral (mains input)
Black	Line (mains input)

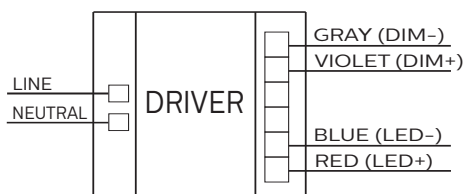

Terminal Color – 0-10V Driver	Value
White	Neutral (Mains input)
Black	Line (Mains input)



# Fortimo LLS ES 4ft 4400lm 1R LV1 36W INT and 36W 0-10V INT

## Wiring (continued)

### Wiring Diagram LED Module

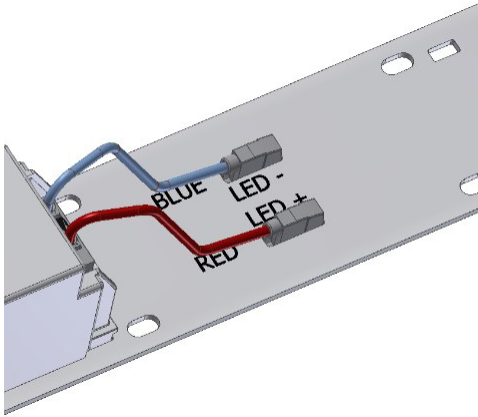

Wire Color – Fortimo LLS ES 36W INT LV1	Value
Blue	LED output minus (-)
Red	LED output plus (+)

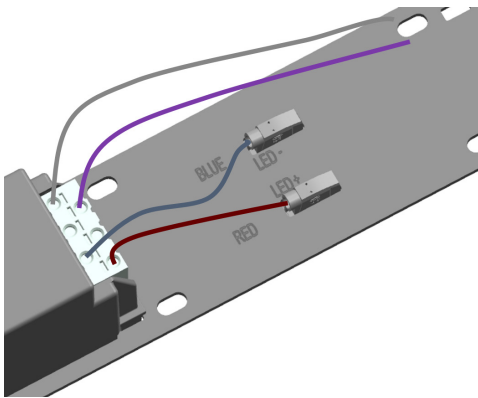

Wire Color – Fortimo LLS ES 36W INT 0-10V LV1	Value
Blue	LED output minus (-)
Red	LED output plus (+)
Violet	Dimming positive (+)
Grey	Dimming GND (-)

# Fortimo LLS ES 4ft 4400lm 1R LV1 36W INT and 36W 0-10V INT

## Mechanical Characteristics

Parameter	Unit	Min	Typ	Max
Length	[mm/in]	1129.5 / 44.47	1130.0 / 44.49	1131.0 / 44.53
Width	[mm/in]	39.8 / 1.57	40.0 / 1.57	40.6 / 1.60
Height Incl. Attached LED Driver	[mm/in]		40.2 / 1.58	40.6 / 1.60

## Mechanical Drawing of Assembled LED Module [mm]

Driver Position 1

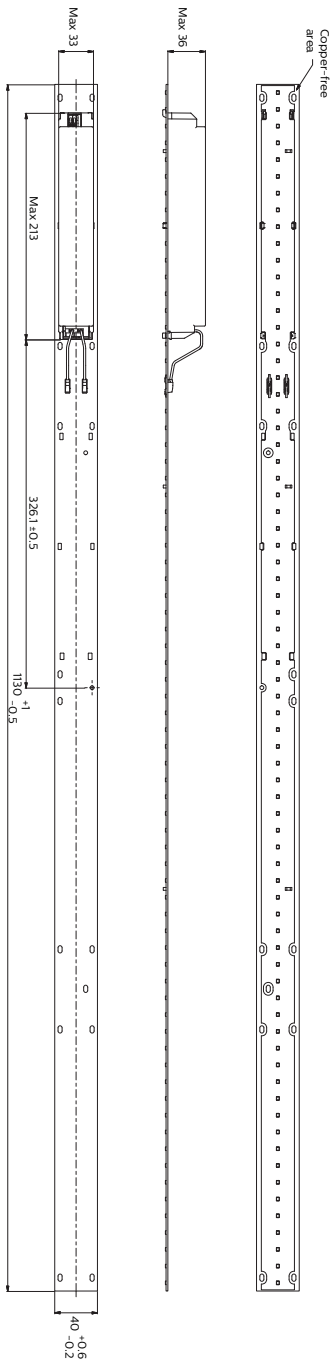

Driver Position 2

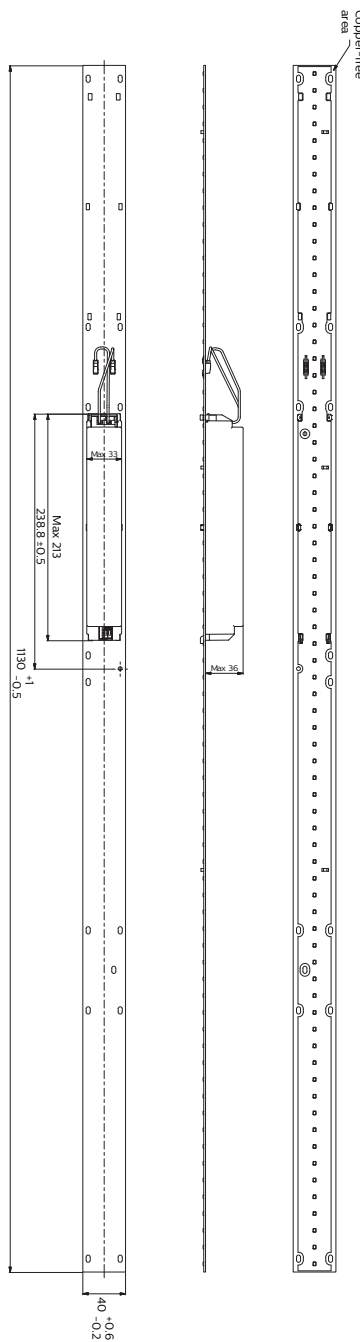

# Fortimo LLS ES 4ft 4400lm 1R LV1 36W INT and 36W 0-10V INT

## Tc Point LocationS

### LED Module Tc Point (Tcase 1)

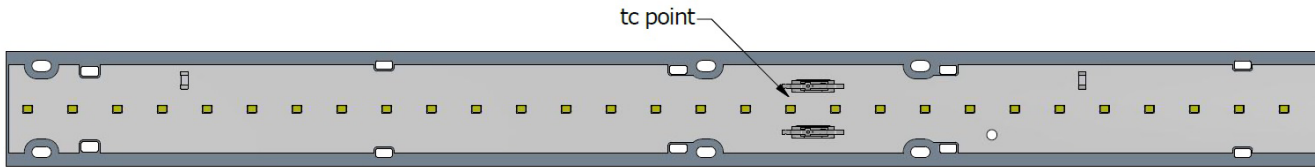

### Standard LED Driver Tc Point (Tcase 2)



### Dimming LED Driver Tc Point (Tcase 2)

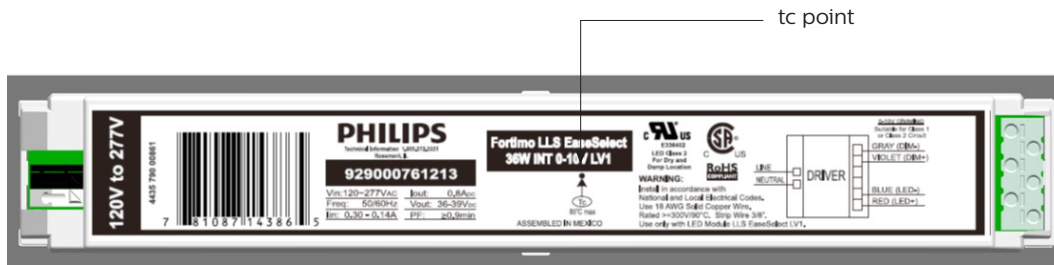

# Fortimo LLS ES 4ft 4400lm 1R LV1 36W INT and 36W 0-10V INT

## LED Module Keep-out Areas

Max available space for mounting to keep electrical clearance

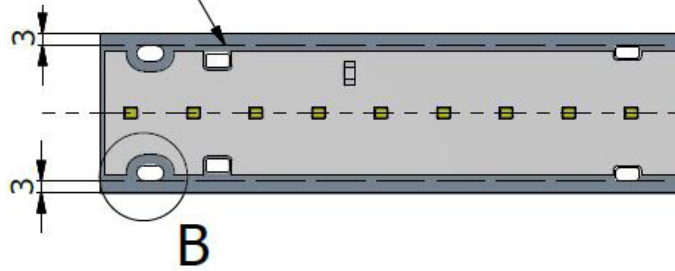

### Detail View B

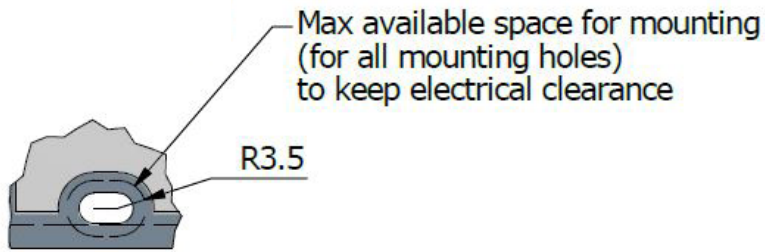

## Lumen Maintenance

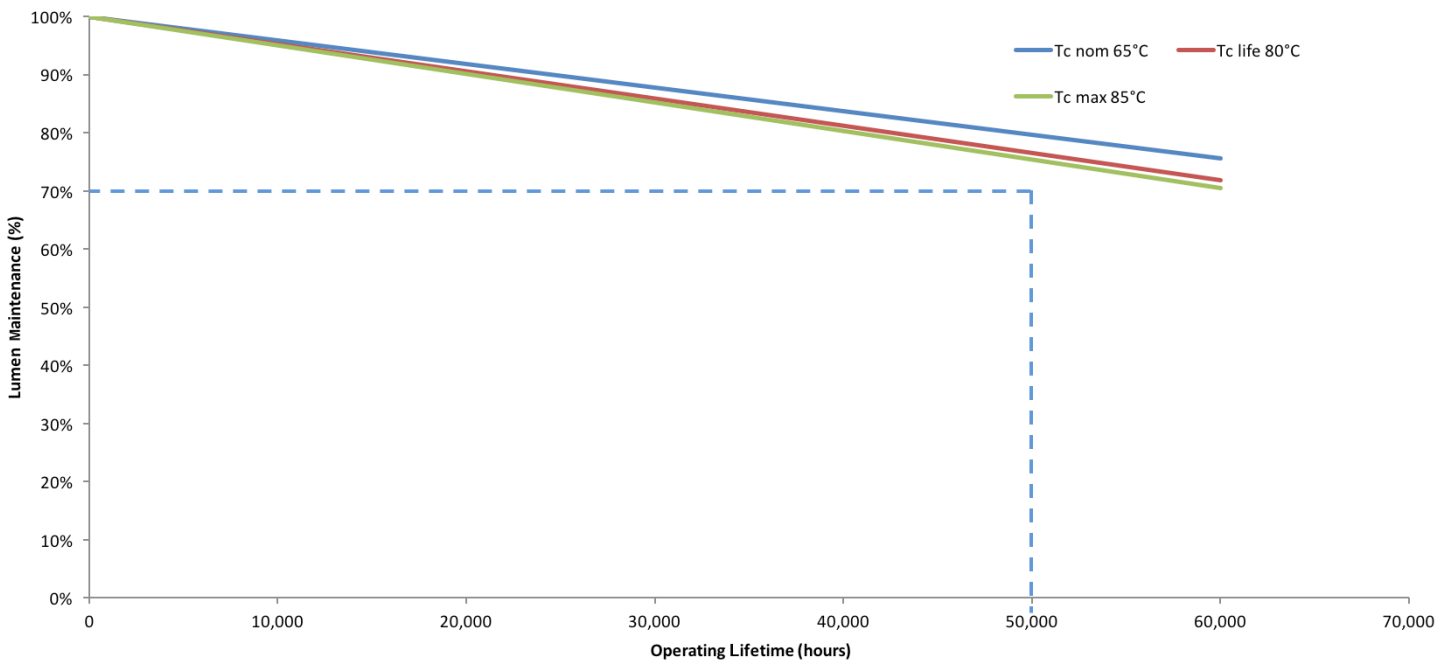

# Fortimo LLS ES 4ft 4400lm 1R LV1 36W INT and 36W 0-10V INT

---

## Application Information

### Compliance and Approval

Approbation	UL & cUL according to UL8750 (UL Recognized), UL1310, UL840
RoHS	Compliant
REACH	Compliant
Environment	Dry and damp location
Overheating Protection	No protection

---

### Storage Temperature and Humidity

Specification Item	Value	Unit
Ambient Temperature (Tc-max)	-25...+65	°C
Relative Humidity	5 - 95	%

---

© 2017 Philips Lighting Holding B.V. All rights reserved.  
Philips reserves the right to make changes in specifications and/or to discontinue any product at any time without notice or obligation and will not be liable for any consequences resulting from the use of this publication.  
[philips.com/ledmodulesna](http://philips.com/ledmodulesna)



Philips Lighting North America Corporation  
10275 W. Higgins Road, Rosemont IL 60018  
Tel: 800-322-2086 Fax: 888-423-1882  
Customer/Technical Service: 800-372-3331  
OEM Support: 866-915-5886

Philips Lighting Canada Ltd.  
281 Hillmount Rd, Markham, ON, Canada L6C 2S3  
Tel. 800-668-9008