

**PHILIPS
ADVANCE**



LED Driver

Xitanium SR

150W 120-277V 0.7A SR
XI150C070V235VSF1

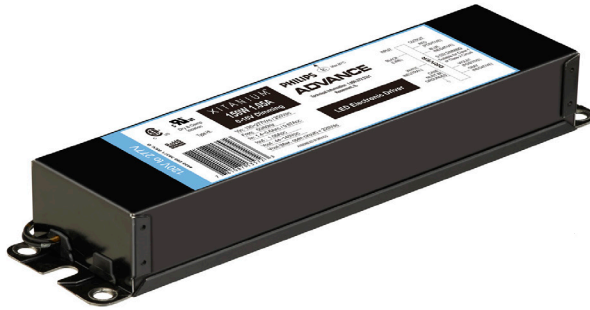

The Philips Advance Xitanium SR LED driver can help reduce complexity and cost of light fixtures used in wireless connected lighting systems. It features a standard digital interface to enable direct connection to SR-certified components. Functionality that ordinarily would require additional auxiliary components is integrated into the driver. The result is a simple, cost-effective light fixture that can enable every fixture to become a wireless node.

Specifications

Input Voltage (Vrms)	Output Power (W)	Output Voltage (V)	Output Current (A)	Efficiency@ Max Load and 70°C Case	Max. Case Temp. (°C)	Input Current (Arms)	Max. Input Power (W) ¹	Inrush Current (Apk/10%-µs)	THD @ Max. Load	Power Factor @ Max. Load	Surge Protection Common/Diff (KV)	Weight (Lbs/kgs)	Envir. Protection Rating
120	150	78-235	0.07-0.70	91	80	1.5	180	57 / 300	<10%	>0.95	6/6	2.1/0.95	UL damp & dry
277				0.65		132 / 276							

Enclosure

	In. (mm)
Case Length	8.38 (211.1)
Case Width	2.35 (59.1)
Case Height	1.49 (37.6)
Mounting Length	9.0 (226.2)
Mounting Width	1.7 (42.9)
Overall Length	9.54 (240.5)

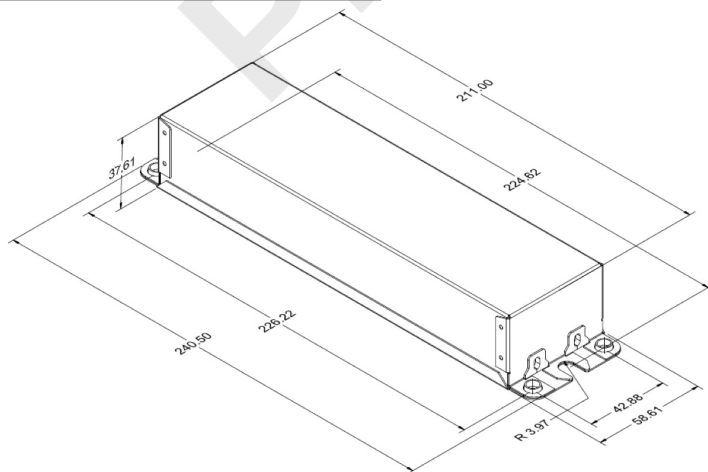

Wiring Diagram

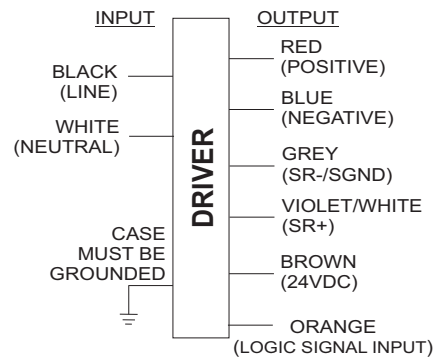

Input and output use lead-wires.

Lead-wires are 18AWG 105C/600V solid copper per UL1452.

Lead Length outside enclosure: 270 mm (±30mm) on all wires.

Dimming	Dimming Range	Minimum Output Current (A)
DALI	10% ~ 100%	0.105

1. Based on 1W load from SR power supply and 6.2W load from auxiliary power supply.

Xitanium SR 150W 120-277V 0.7A

Electrical Specifications

All the specifications are typical and at 25°C Tcase unless specified otherwise.

Features

- Compatible with SR-Certified devices
- Standard digital interface based on DALI including integral power supply
- Auxiliary power supply for higher-power device requirements
- Accurate energy reporting
- Low standby power
- Drive current setting via SimpleSet
- 5-year limited warranty¹

Benefits

- Enables interoperability with multiple sensor/network system vendors
- Reduces cost and complexity of outdoor connected lighting systems
- Eliminates need for high-voltage relays to increase system reliability

Application

- Area
- Roadway
- Parking garages
- Floodlights

1. Philips Advance Xitanium LED drivers are designed and manufactured to engineering standards correlating to an average life expectancy of 50,000 hours of operation at maximum rated case temperature. Minimum 90% survivals based on MTBF modeling.

Product Data

Ordering Information	
Order Code	XI150C105V157VSF1
Full Product Code	XI150C105V157VSF1M (Mid-pack, 10pcs/box)
Full Product Name	XITANIUM 150W 1.05A 120-277V SR
Net Weight Per Piece	0.82 KG / 1.8 lbs
Input Information	
Inrush Current	Per NEMA 410
Line Voltage (AC Operation)	120-277VAC +/- 10%
Line Current	1.50A @ 120V, 0.65A @ 277V
Line Frequency	50/60Hz
Surge Protection	Refer to table
Output Information	
Output Voltage Range	78VDC to 235VDC
Output Current Range	0.07A to 0.70A
Output Current Ripple	<15% at max lout (ripple = pk-avg/avg) Low frequency (<120 Hz) content <5%
Output Current Tolerance	±5% at max output current
Open Circuit Voltage	200VDC
Protections	Short Circuit and Open Circuit Protection for LED + and LED-
Features	
AOC (Adjustable Output Current)	0.105A to 1.05A via SimpleSet programming (refer to graphs and notes)
Life @ TC 80°C	50000 hr [nom] (refer to graphs)
Suitable for Outdoor Use?	Yes
Interfaces	AOC (SimpleSet), SR (DALI 2.0), Logic Signal Input (LSI)
Min Ambient Temp	-40°C
Max Case Temperature (Tcase)	80°C
Input Over-voltage	Can survive input over-voltage stress of 320VAC for 48 hours and 350VAC for 2 hours
Earth Leakage Current	0.75 mA [max]
THD Total	Refer to graph
Power Factor	Refer to graph
Efficiency	Refer to table
Power Reporting Accuracy	± 2%

Xitanium SR 150W 120-277V 0.7A

Electrical Specifications

All the specifications are typical and at 25°C Tcase unless specified otherwise.

Product Data (continued)

SR Interface	
Digital Protocol	DALI 2.0
SR Power Supply	52-60mA (55mA typ.), 12vdc-20vdc (18vdc typ.) (refer to graph)
Auxiliary Power Supply	
Power	3W continuous, 10.5W peak for 1.2ms
Voltage	24V+/-10%
Ripple	300mV peak-peak for resistive load
Protection	Overload and short circuit protected
Last Gasp Energy	200mJ typ.
Logic Signal Input (LSI)	
Dry Contact Input	Yes
Logic Low	<3V or open
Logic High	>7V
Max Current Draw	2mA
Environment & Approbation	
Agency Approbations	UL8750, UL1310, UL935, CSA-C22.2 No. 250.13-12, CSA C22.2 No. 223
Audible Noise	<24dB Class A
Isolation Between Output and Input	Refer to table
Isolation of Controls	Refer to table
EMC (Electromagnetic Compliance)	Meets FCC 47 Part 15 Class A
Envir. Protection Rating	UL Dry & Damp

Xitanium SR 150W 120-277V 0.7A

Electrical Specifications

All the specifications are typical and at 25°C Tcase unless specified otherwise.

SR Power Supply Characteristics (Typical)

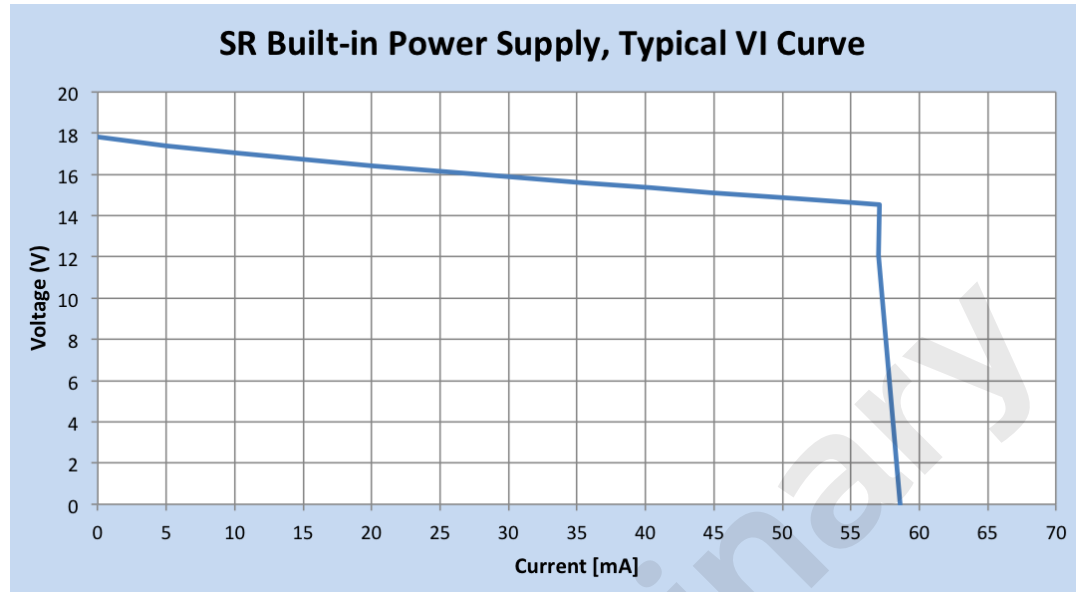

Logic Signal Input (LSI) Characteristics (Typical)

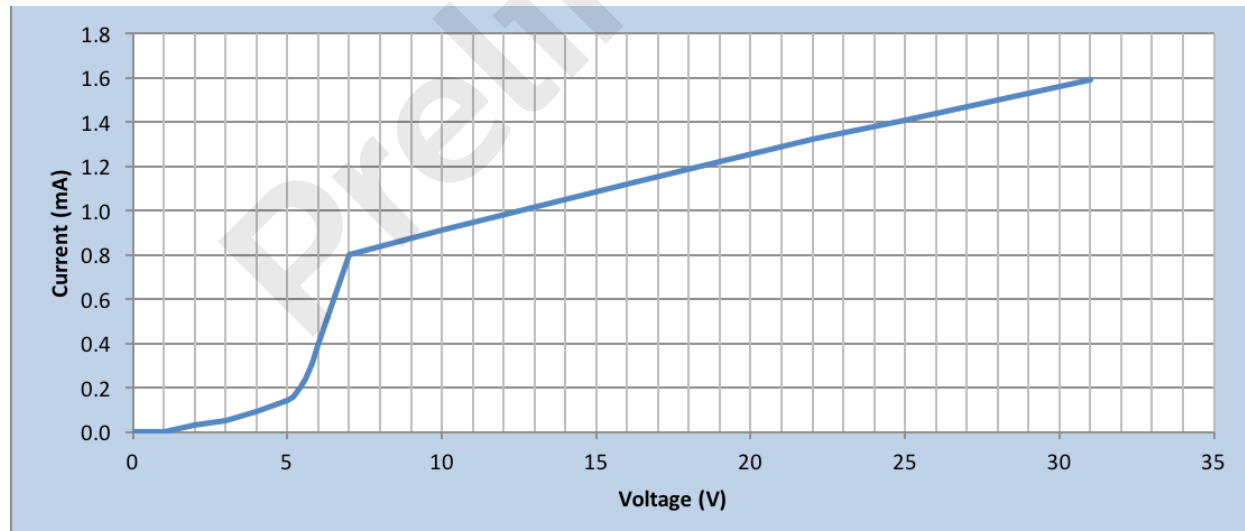

Xitanium SR 150W 120-277V 0.7A

Electrical Specifications

All the specifications are typical and at 25°C Tcase unless specified otherwise.

Operating Window

The Driver Current Cutback feature provides for an increased output voltage with a reduced output current during abnormal LED operation, such as cold weather starting.

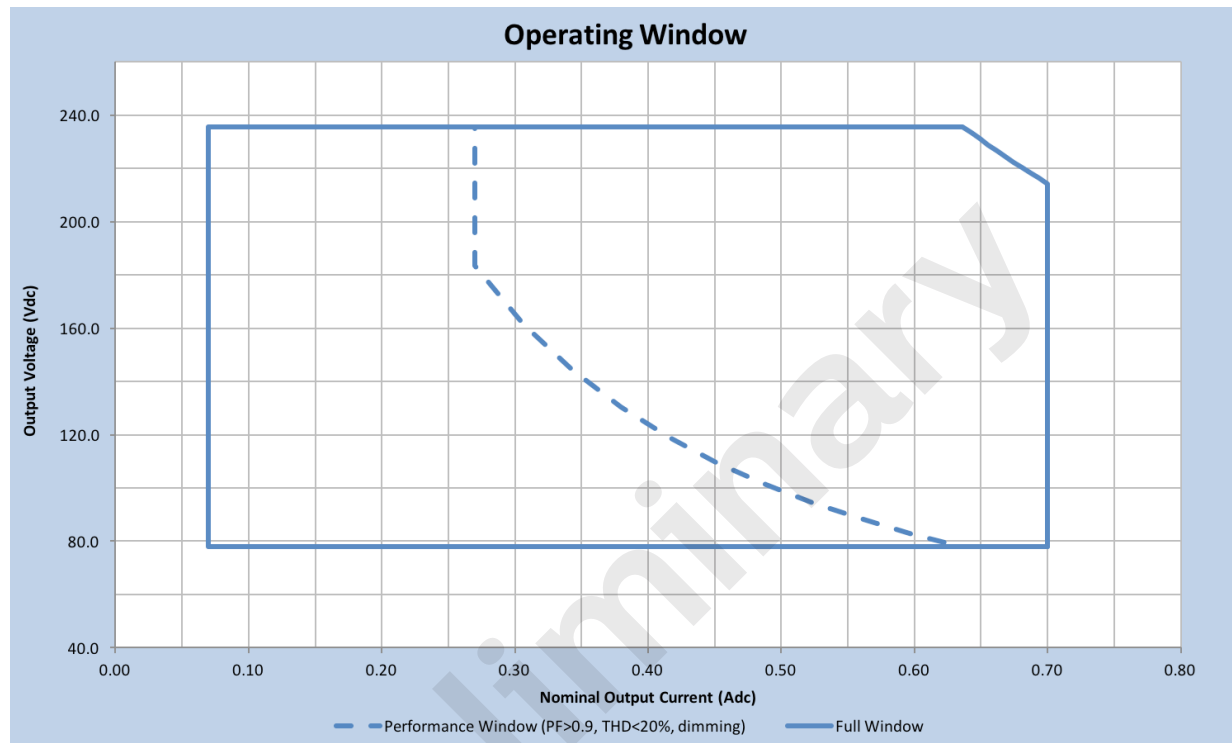

Xitanium SR 150W 120-277V 0.7A

Electrical Specifications

All the specifications are typical and at 25°C Tcase unless specified otherwise.

Dimming Characteristics

Dimming is accomplished through the two-wire SR connection to the sensor. DALI standard IEC62386_107 Edition 1 defines the linear dimming curve as well as the command for switching between logarithmic and linear curves. Only a linear dimming curve is utilized.

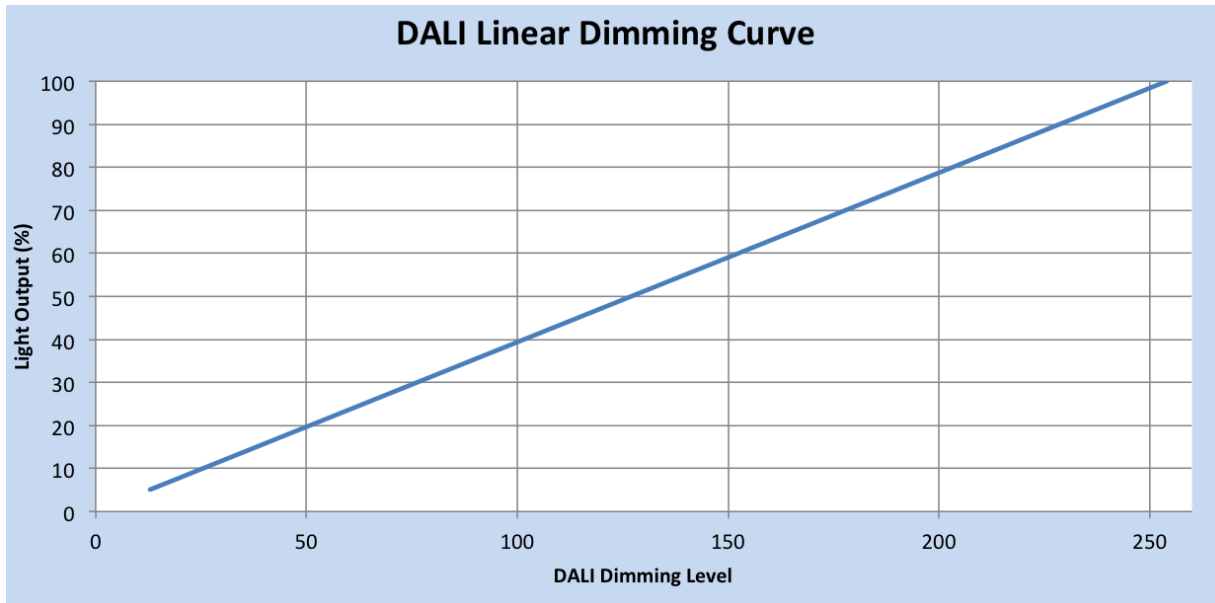

Xitanium SR 150W 120-277V 0.7A

Performance Characteristics

Based on measurements on a typical sample. The accuracy of the measurements is within the tolerance of the measurement instruments. The graphs are meant to be a guideline and not a specification.

Efficiency vs. Output Power @ $T_c = 70^\circ\text{C}$

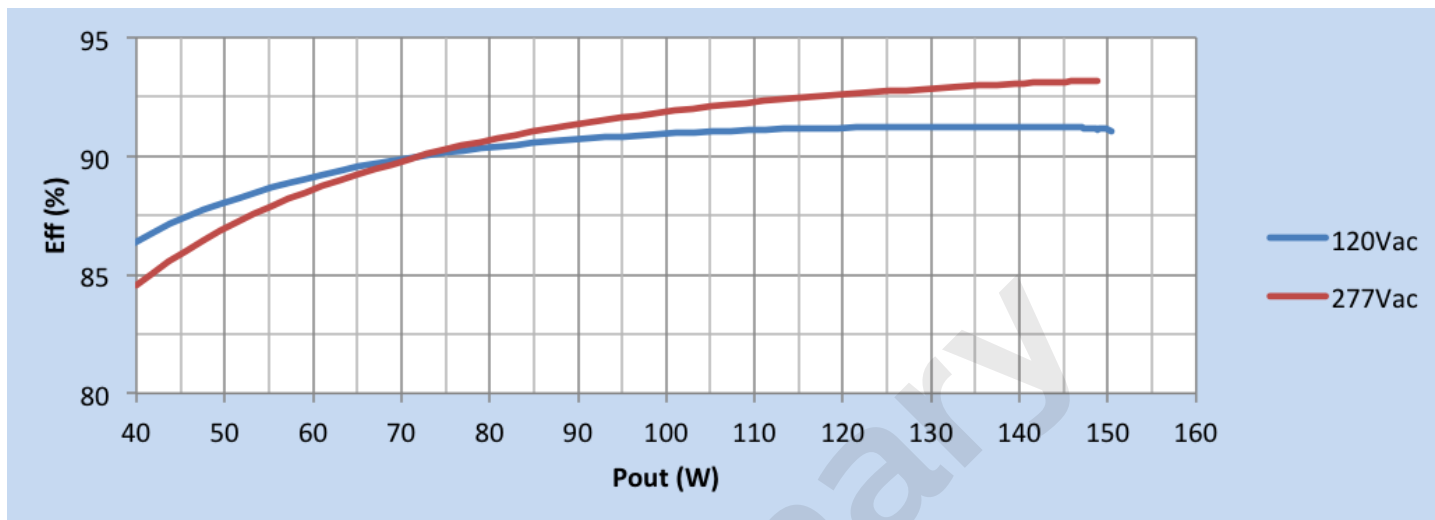

Efficiency vs. Output Voltage @ $T_c = 70^\circ\text{C}$ $I_{out} = 1.050\text{A}$

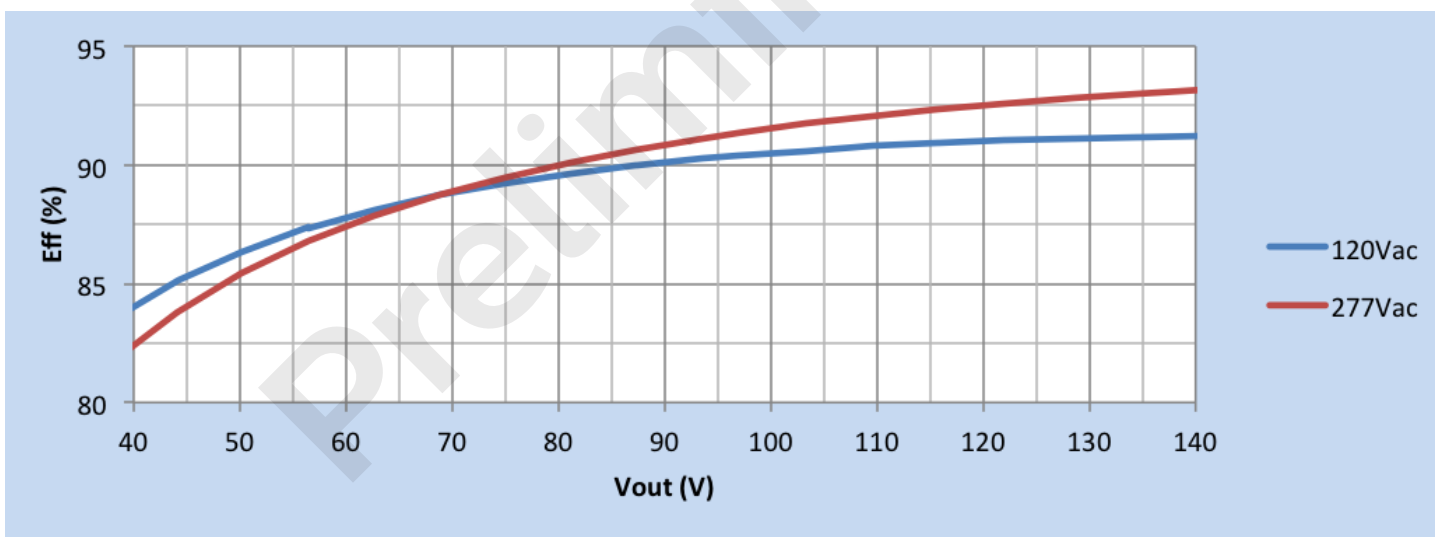

Xitanium SR 150W 120-277V 0.7A

Performance Characteristics

Based on measurements on a typical sample. The accuracy of the measurements is within the tolerance of the measurement instruments. The graphs are meant to be a guideline and not a specification.

Power Factor vs. Output Power @Tc=70°C

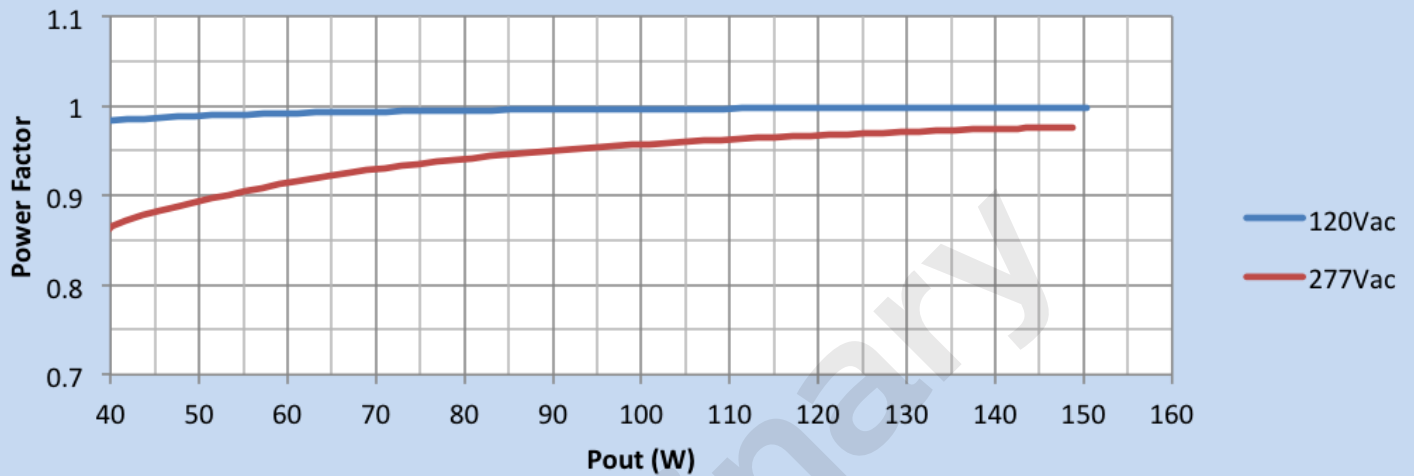

THD vs. Output Power @Tc=70°C

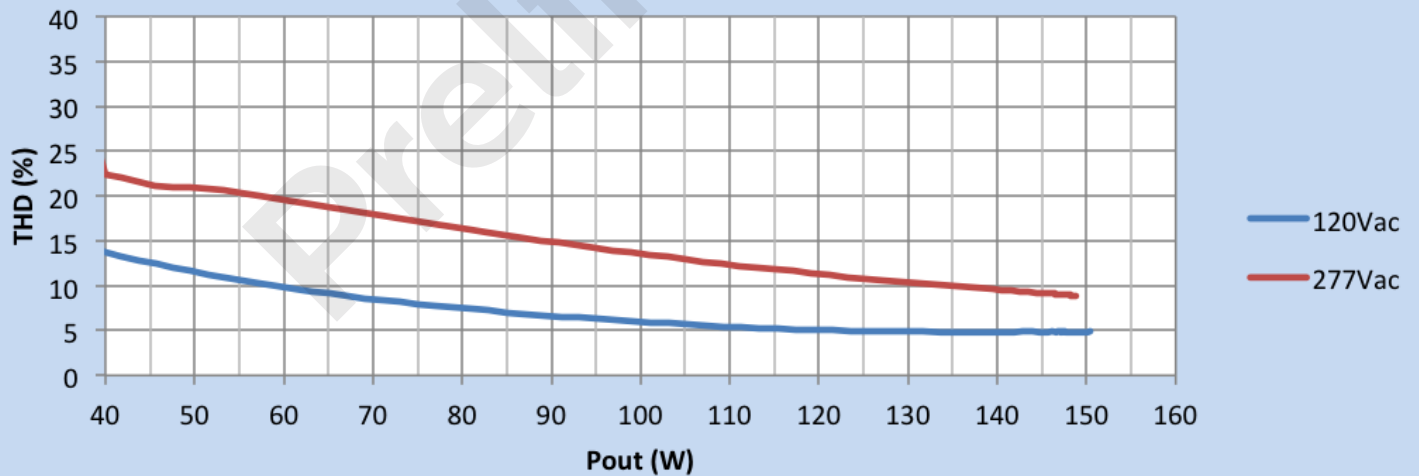

Xitanium SR 150W 120-277V 0.7A

Electrical Specifications

All the specifications are typical and at 25°C Tcase unless specified otherwise.

Output Current vs. Driver Case Temperature:

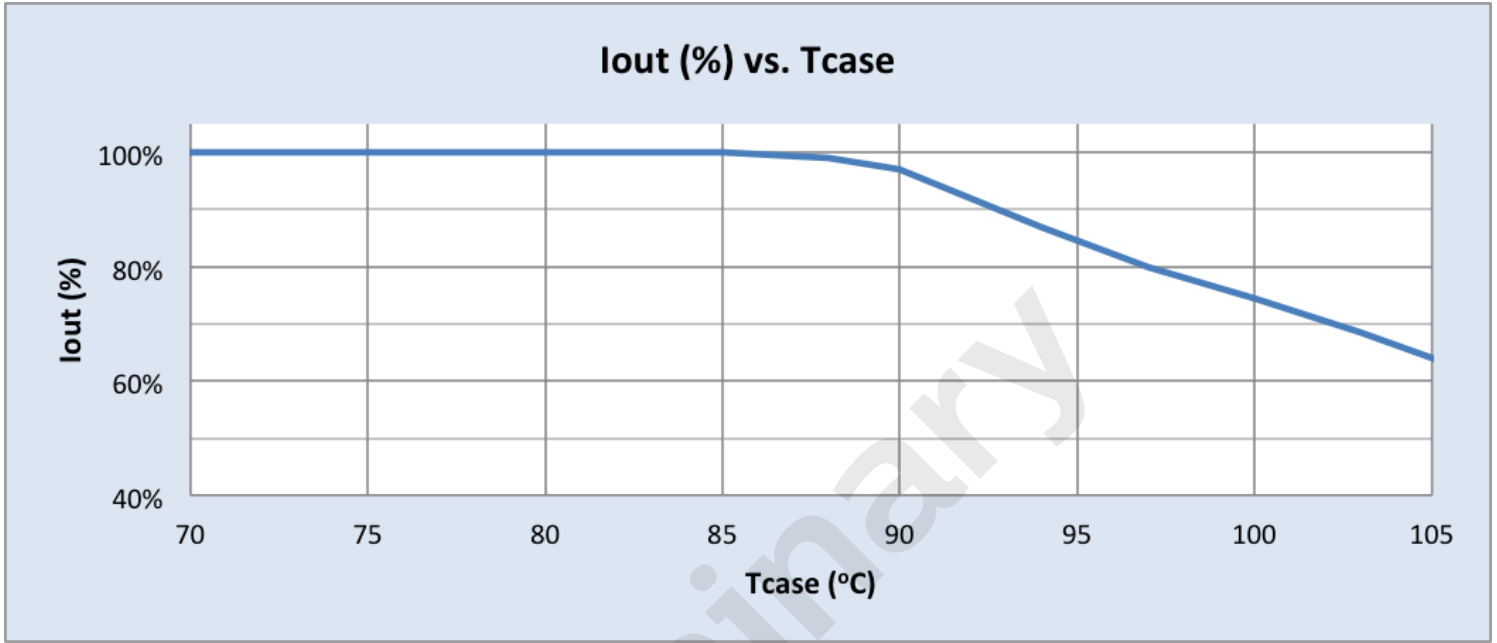

Driver Lifetime vs. Driver Case Temperature:

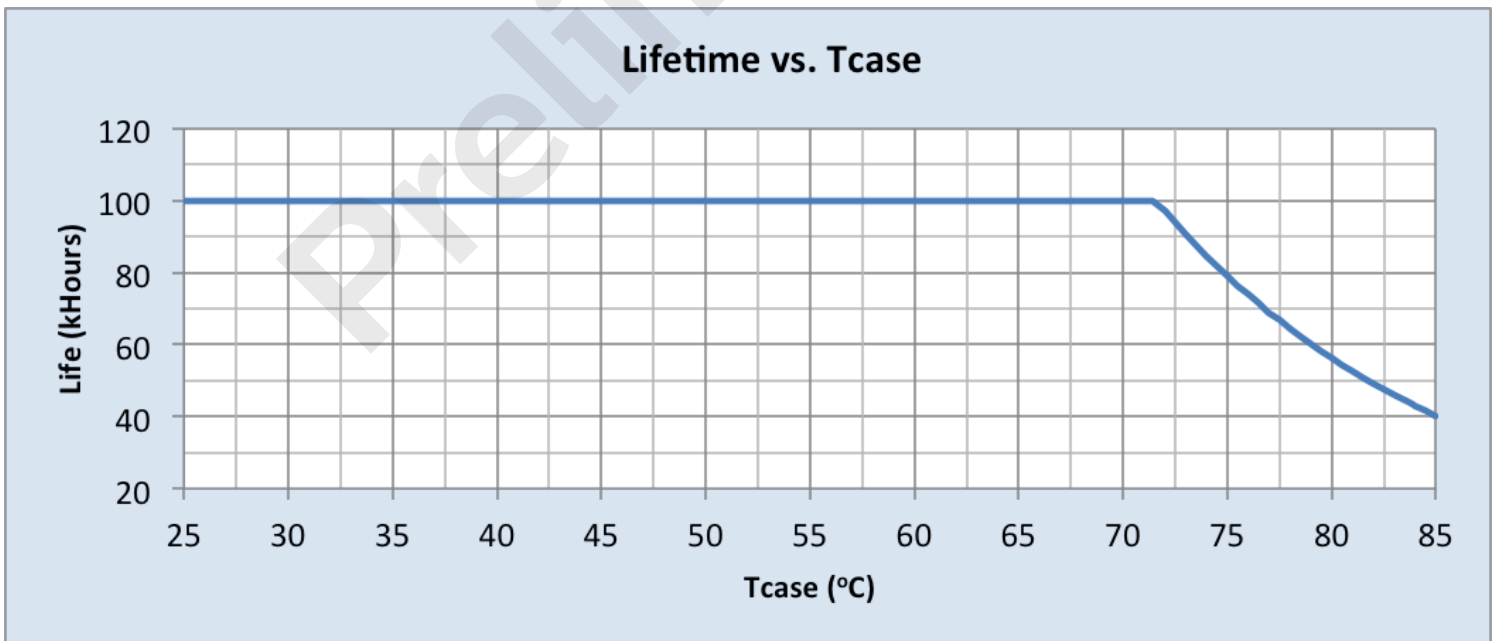

Xitanium SR 150W 120-277V 0.7A

Inrush Current Info:

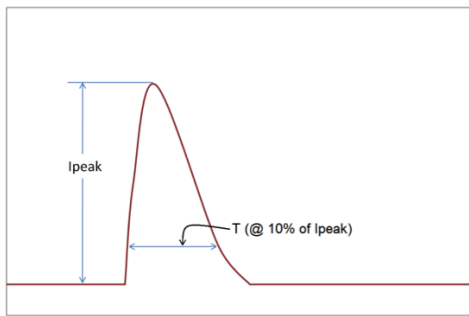

V_{in}	I_{peak}	T (@ 10% of I_{peak})
120 Vac	57A	300 μ s
277 Vac	132A	276 μ s

Inrush current is measured at peak of the corresponding line voltage, source impedance per NEMA 410.

Lightning Surge Info:

ANSI Surge Type	Differential Mode (L-N)	Common Mode (L-G, N-G, L&N-G)
1.2/50 μ s Combination Wave (w/t 2 Ω)	6kV	6kV

Isolation:

Isolation	Input	Output	0-10V (Class 1 & 2)	Enclosure
Input	NA	2xU+1kV	2.5KVac	2xU+1kV
Output	2xU+1kV	NA	2.5KVac	2xU+1kV
0-10V (Class 1 & 2)	2.5KVac	2.5KVac	NA	2xU+1kV
Enclosure	2xU+1kV	2xU+1kV	2xU+1kV	NA

UL Conditions of Acceptability

Please contact your Philips representative for a copy of the latest UL Conditions of Acceptability (COA).

© 2016 Philips Lighting Holding B.V. All rights reserved.
Philips reserves the right to make changes in specifications and/or to discontinue any product at any time without notice or obligation and will not be liable for any consequences resulting from the use of this publication.
philips.com/leddrivers



Philips Lighting North America Corporation
10275 W. Higgins Road, Rosemont IL 60018
Tel: 800-322-2086 Fax: 888-423-1882
Customer/Technical Service: 800-372-3331
OEM Support: 866-915-5886

Philips Lighting Canada Ltd.
281 Hillmount Rd, Markham, ON, Canada L6C 2S3
Tel. 800-668-9008