

PHILIPS

LED Modules

Fortimo FastFlex

2x8/757 DS gen3



The Philips Fortimo FastFlex LED system gen 3 portfolio has been designed to offer a suitable solution to OEMs who want to distinguish themselves through their fixture design and speed to market, as well as OEMs wanting to differentiate their propositions based on optical (photometric) performance. As a result, the standard Fortimo FastFlex gen 3 2x8 and 2x4 are designed for OEMs looking for a “one-stop shop” where board and lenses are provided by Philips to help support a short fixture development cycle while enabling good optical flexibility with FastFlex’s eight standard light distributions. For OEMs looking to have a unique photometric performance, the new Fortimo FastFlex differentiation family (DA and DS gen 3) are designed to operate together with third-party lenses, enabling a broad number of possible optical configurations and allowing the use of standard components for a unique photometric result.

Basic Configuration



To operate a system you will need one or more FastFlex DS LED boards and a compatible Philips Advance Xitanium LED driver.

Fortimo FastFlex 2x8/757 DS gen 3

Features

- State-of-the-art specifications
- Temperature and driving current designed for fixture optimization
- Optical flexibility via third-party lenses
- Flexible lumen output
- Range of CCT and CRI versions

Benefits

- Enables OEM optical differentiation with lenses from third-party portfolios matching every project's needs
- Unparalleled lumen-per-watt for fixture performance

Application

- Road lighting
- Urban street lighting
- Flood and area lighting
- Tunnel lighting
- High-bay lighting

Logistical Data

Specification item	Value
Product Name	Fortimo FastFlex LED board 2x8/757 DS gen3
Product Number	9290 009 55606
Pieces per Box	25
Approval Marks	CE, ENEC, UL
RoHS and Reach	Compliant with European Directives

Operating Conditions

Specification item	Value	Unit	Condition
Reference Output Current	530	mA	
Reference Case Temperature	75	°C	
Max Tc	85	°C	
Ambient Temperature	25	°C	Temperature outside luminaire
Min Driver Current	100	mA	
Max Driver Current	1,050	mA	
Max ΔT (Tambient -Tcase)	50	°C	
Min Ambient Temperature	-40	°C	

Fortimo FastFlex 2x8/757 DS gen 3

Released System Combinations

For system combination possibilities and drivers' compatibility, please visit the Philips Easy Design-in Tool website: <https://www.na.easydesignintool.philips.com/select-module/7;jsessionid=940A11F3F44FC8E0746C63A3383A2122>

Performance Characteristics (under reference operating If and Tcase = 75°C)

Specification item	Min	Typ	Max	Unit
Lumen Output	3150	3575	3960	lm
Efficacy	119	151	–	lm/W
Power Consumption	21.2	23.8	26.5	W
Forward Voltage	–	44.9	50	V
Working Voltage (between input to metal mounting plate)	–	–	400	lm/W
Surge Protection @ Module Level	–	–	6	KV
Correlated Color Temperature (CCT)	–	5685	–	K
Color Rendering Index (CRI)	–	70	–	Ra
Initial Color Accuracy	–	4	–	SDCM
Color Accuracy at 55,000 hours	–	–	7	SDCM
Lumen Maintenance	>55,000*	–	–	hour
Product Lifetime	>55,000*	–	–	hour

*Charts presenting module's Tc and current Vs expected lifetime (Up to 100,000 hours), as well as module's Tc and current Vs expected lumen depreciation (L70 and above) are available via your sales representative.

Note: The lumen output is specified at board level (lens optical losses not included). When using standard Fortimo Fastflex lenses, optical losses of 4% need to be taken into account.

Note: Philips maintains a tolerance of ± 7% on luminous flux, ± 2 on CRI measurements and ± 5% on CCT measurements.

Driver current (mA)	Typ Luminous flux (lm)	Typ efficacy (lm/W)	Typ thermal power (W)	Type power (W)	Max power (W)
350	2475	160	8.6	15.4	17.2
530	3575	151	14.0	23.8	26.5
700	4535	142	19.5	32	35.6
1050	6222	130	30.6	46.9	53

The Fortimo FastFlex Gen 3 has been specified with a typical color consistency of 4 SDCMs at the beginning of its lifetime. Application conditions may affect the way how color consistency of the product changes during the given lifetime of the product. In the case of the Fortimo FastFlex DA an DS versions, variations at the lens of your section need to be taken into account.

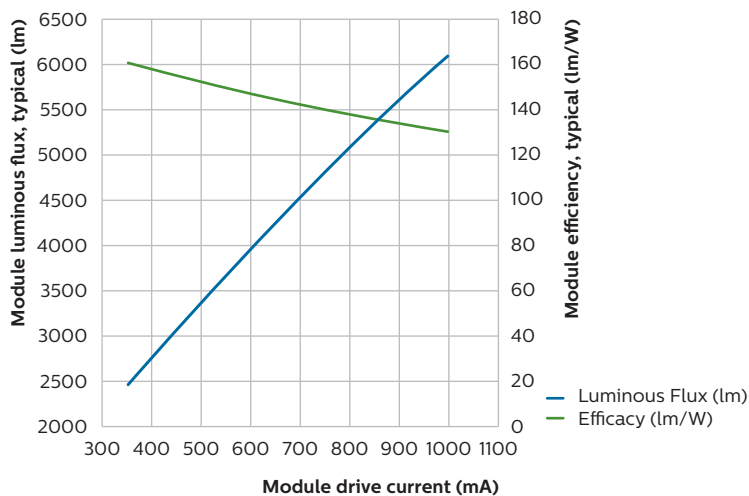

Temp T _c Current	55°C	65°C	75°C	85°C
350 mA	✓	✓	✓	✓
530 mA	✓	✓	✓	✓
700 mA	✓	✓	✓	✓
1050 mA	✓	✓	✓	<55Kh

Note : Values supported in the Fortimo FastFlex version with SKU: 103136275

Fortimo FastFlex 2x8/757 DS gen 3

Mechanical Characteristics

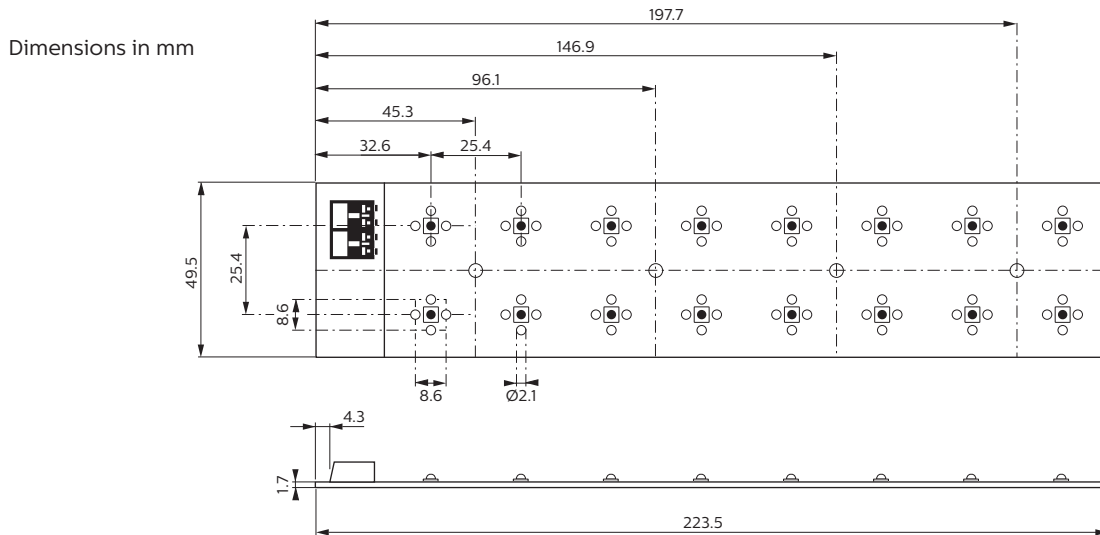

FastFlex LED module assembly

Mounting hole pattern for FastFlex DS 2x8

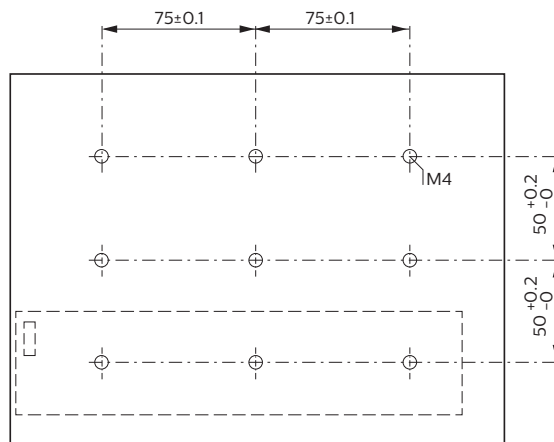

Optical Characteristics

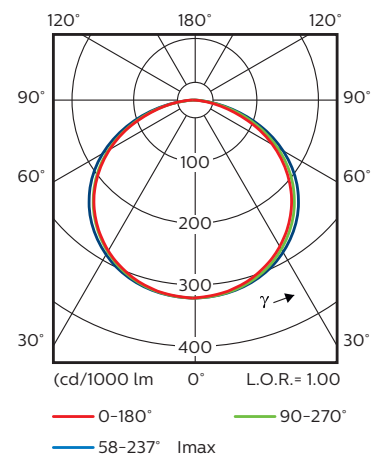
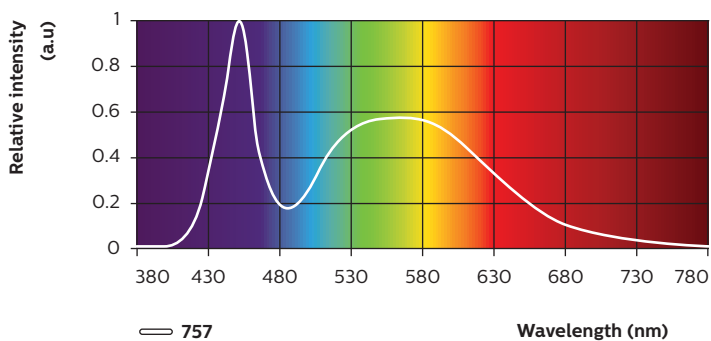

Fortimo FastFlex 2x8/757 DS gen 3

Electrical Characteristics

Connection between driver and FF-module

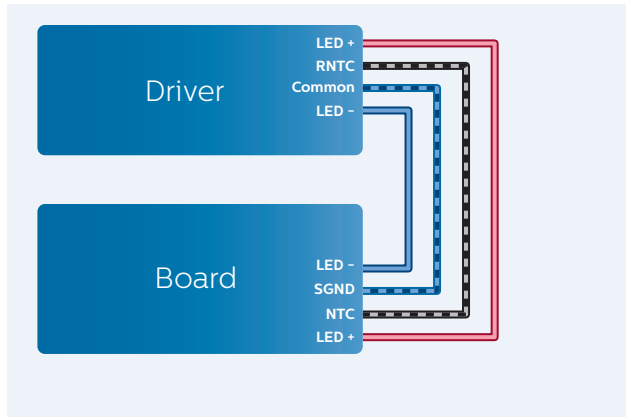

Signal	Description
LED+	LED driver current input (+)
LED-	Power ground (-)
NTC	Temperature sensor (RNTC)
SGND/Common	Signal ground

The temperature protection has been implemented with an NTC resistor in series with a fixed resistor where the fixed resistor has a value 1.1 kOhm and the NTC has a value of 15 kOhm (e.g., Murata NCP15XW153E03RC or equivalent).

It is recommended to use solid wire AWG 20-22 (0.5 mm²-0.33 mm²) with suitable isolation (depending on the application). It is recommended to use Molex Lite-trap specification for strip length & tolerance for wiring (spec.= 8 +/-0.5 mm).

Multiple boards on one driver

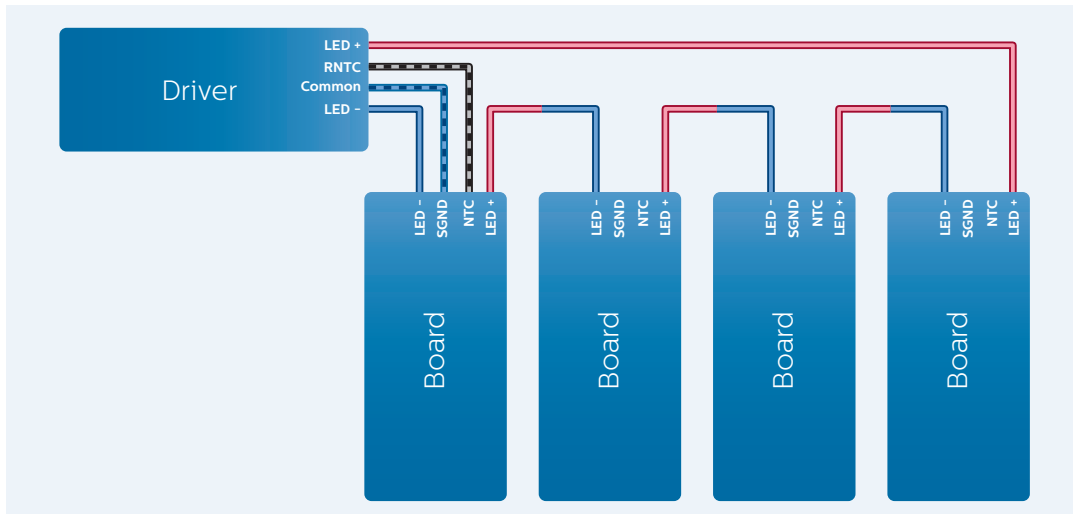

If a system consists of multiple FastFlex boards connected to a single driver:

- the first board connected to the driver is the master
- only this board is monitored by the NTC

© 2016 Philips Lighting Holding B.V. All rights reserved.
Philips reserves the right to make changes in specifications and/or to discontinue any product at any time without notice or obligation and will not be liable for any consequences resulting from the use of this publication.
philips.com/ledmodulesna



Philips Lighting North America Corporation
10275 W. Higgins Road, Rosemont IL 60018
Tel: 800-322-2086 Fax: 888-423-1882
Customer/Technical Service: 800-372-3331
OEM Support: 866-915-5886

Philips Lighting Canada Ltd.
281 Hillmount Rd, Markham, ON, Canada L6C 2S3
Tel. 800-668-9008