

**PHILIPS
ADVANCE**

LED Driver

Xitanium

220W 347-480V 1.05A 0-10V
XH220C105V210CNA1



Intertek
Class P
Conforms to UL STD 8750
Certified to CAN/CSA STD
C22.2 No. 250.13

Class P
For Dry and Damp Location

Long-lasting and low-maintenance, LED-based light sources are an excellent solution for all outdoor lighting applications. For optimal performance, these solutions require reliable drivers matching the long lifetime of the LEDs. The Philips Advance Xitanium LED outdoor driver portfolio offers a range of products specially designed to operate LED solutions in outdoor applications. These drivers are designed for hard-wired integration into outdoor luminaires for the most rugged applications. They operate to specification under wide temperature and electrical ranges to help ensure reliability.

Specifications

Input Voltage (Vrms)	Output Power (W)	Output Voltage (V)	Output Current (A)	Efficiency@ Max. Load and 70°C Case	Max. Case Temp. (°C)	Input Current (Arms)	Max. Input Power (W)	THD @ Max. Load	Power Factor @ Max. Load	Surge Protection Common/Diff (KV)	Envir. Protection Rating
347	220	105-210	1.05	93.5	Life - 85°C UL - 90°C	0.71	245	<10%	>0.95	6	UL Dry & Damp and Type HL
480				94		0.51					

Enclosure

	In. (mm)
Case Length (L2)	9.31 (236.4)
Case Width (W)	2.33 (59.1)
Case Height (H)	1.49 (37.9)
Mounting Length (M)	9.91 (251.6)
Overall Length (L1)	10.47 (265.9)

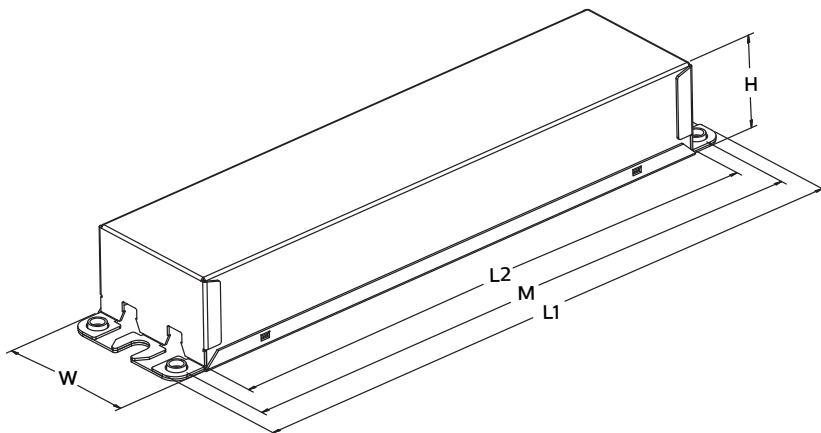

Wiring Diagram

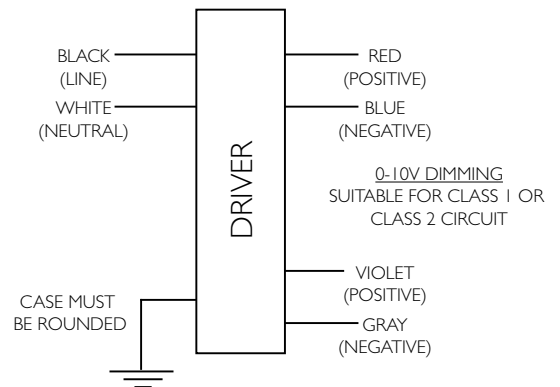

Dimming	Dimming Range (with specified dimmers)	Minimum Output Current (A)
0-10V Analog Class 1 and 2 Wiring	10% ~ 100%	0.105

Xitanium 220W 347-480V 1.05A 0-10V dimming

Features

- 50,000+ hour lifetime¹
- Excellent thermal performance
- 6kV combi-wave surge rating to comply with ANSI C82.77-5 CAT C low
- Efficiency of > 90% over the complete range of operation

Benefits

- Enables long life luminaire designs
- Allows luminaire designs for a wide range of ambient environments
- No external surge protection required to pass C82.77-5 CAT C low
- Enables a high lm/W solution

Application

- Area
- Roadway
- Parking garages
- Floodlights
- High-mast

Electrical Specifications

All the specifications are typical and at 25°C Tcase unless specified otherwise.

Product Data

Order Information

Full Product Code	XH220C105V210CNA1M (Mid-Pack, 10 pcs/Box)
Line Frequency	50/60Hz
Min. Mains Voltage Operational	312 Vac
Max. Mains Voltage Operational	524 Vac

Output Information

Maximum Open Circuit Voltage	330V
Output Current Ripple (ripple = peak to average / average)	15% max. @ max. Iout Low frequency (≤ 120 Hz) content <5%
Output Current Tolerance (at maximum output current)	<5%
Protections	Short Circuit, Open Circuit Protection for LED + and LED – and Temperature Foldback

Features

0-10V Dimming	150 μ A ($\pm 3\%$) source current from driver. See dim curve for detail.
---------------	---

Environment & Approbation

Operating Ambient Temp. Range	-40°C to +55°C
Max. Case Temperature (Tcase)	90°C
Agency Approbations	UL 8750, CSA 250.13, UL Listed, ETL Class P
Electromagnetic Compliance	FCC Title 47 Part 15 Class A
Audible Noise	<24dB Class A
Weight	2.5 Lbs / 1.12 kgs

1. Philips Advance Xitanium LED drivers are manufactured to engineering standards correlating to a designed and average life expectancy of 50,000 hours of operation at maximum rated case temperature. Minimum 90% survivals based on MTTTF modeling.

Xitanium 220W 347-480V 1.05A 0-10V dimming

Electrical Specifications

All the specifications are typical and at 25°C Tcase unless specified otherwise.

Driver Current Cutback

The driver current cutback feature provides for an increased output voltage with a reduced output current during abnormal LED operation, such as cold weather starting.

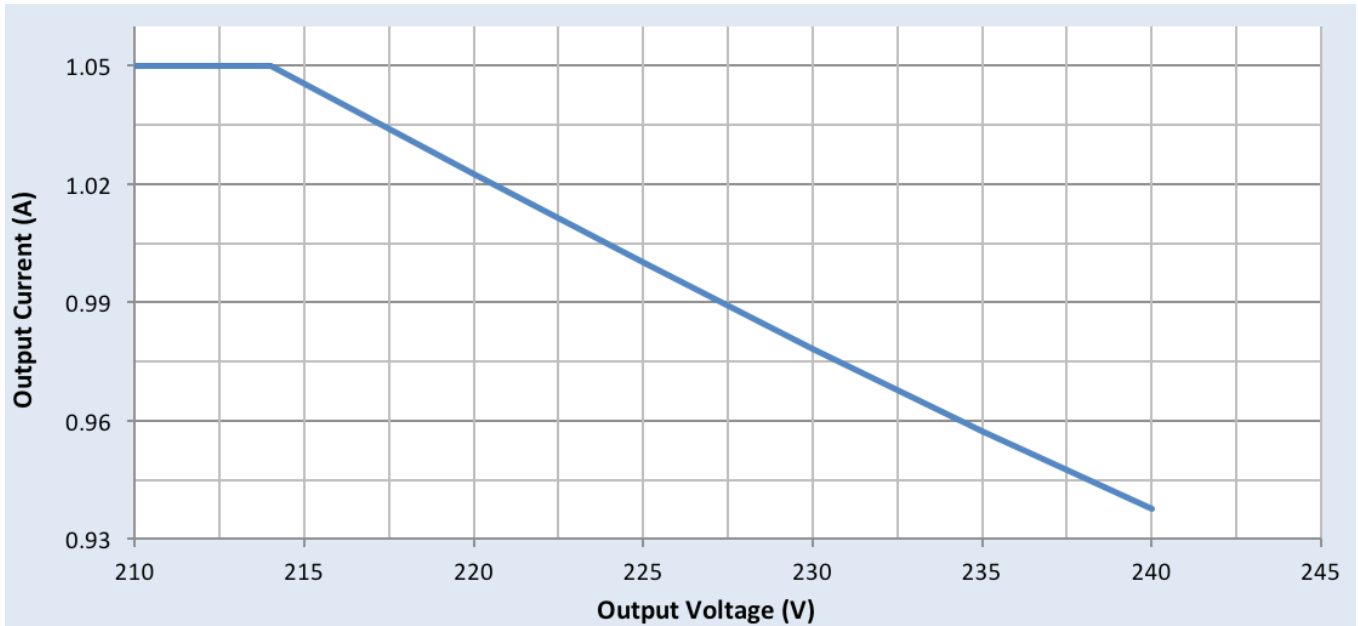

Xitanium 220W 347-480V 1.05A 0-10V dimming

Electrical Specifications

All the specifications are typical and at 25°C Tcase unless specified otherwise.

0-10V Dimming Curve

Dimming source current from the driver: 150µA (@ 0<Vdim<8V)

Minimum dim level: Factory default 10% of Iout

Maximum output voltage on the dimming wires: 12V

Approved Dimmer List

Manufacturer	Manufacturer Part Number
Lutron	Visit www.lutron.com/advance for a list of dimmers (Mark VII) that will work with this driver
Leviton	IllumaTech IP7 series
Philips	Sunrise - SR1200ZTUNV

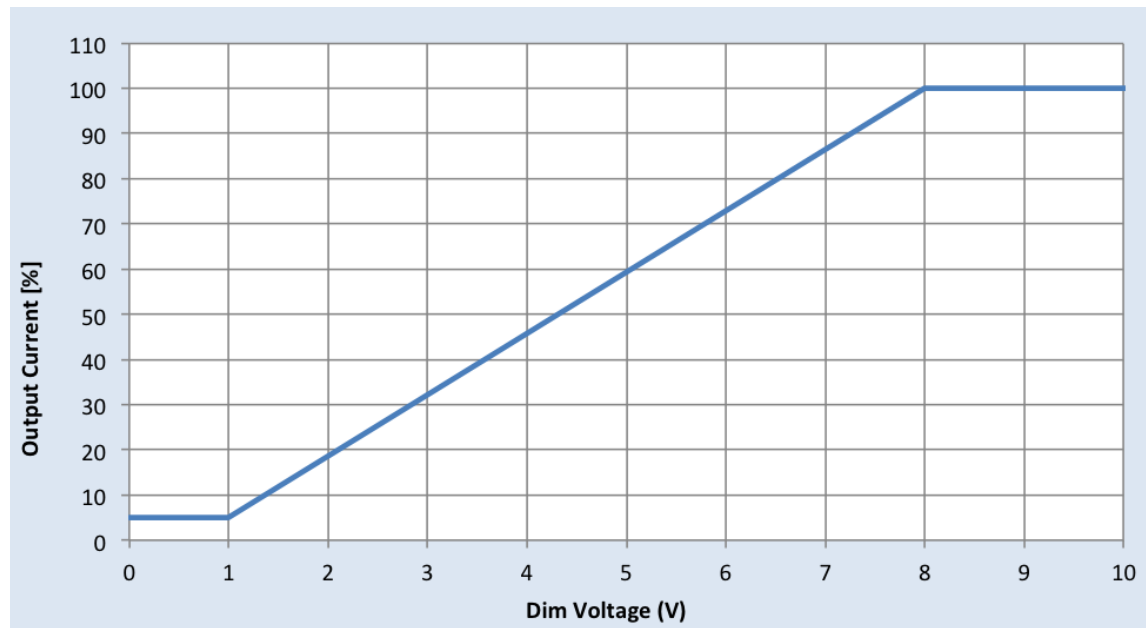

Xitanium 220W 347-480V 1.05A 0-10V dimming

Electrical Specifications

All the specifications are typical and at 25°C Tcase unless specified otherwise.

Output Current Vs. Driver Case Temperature

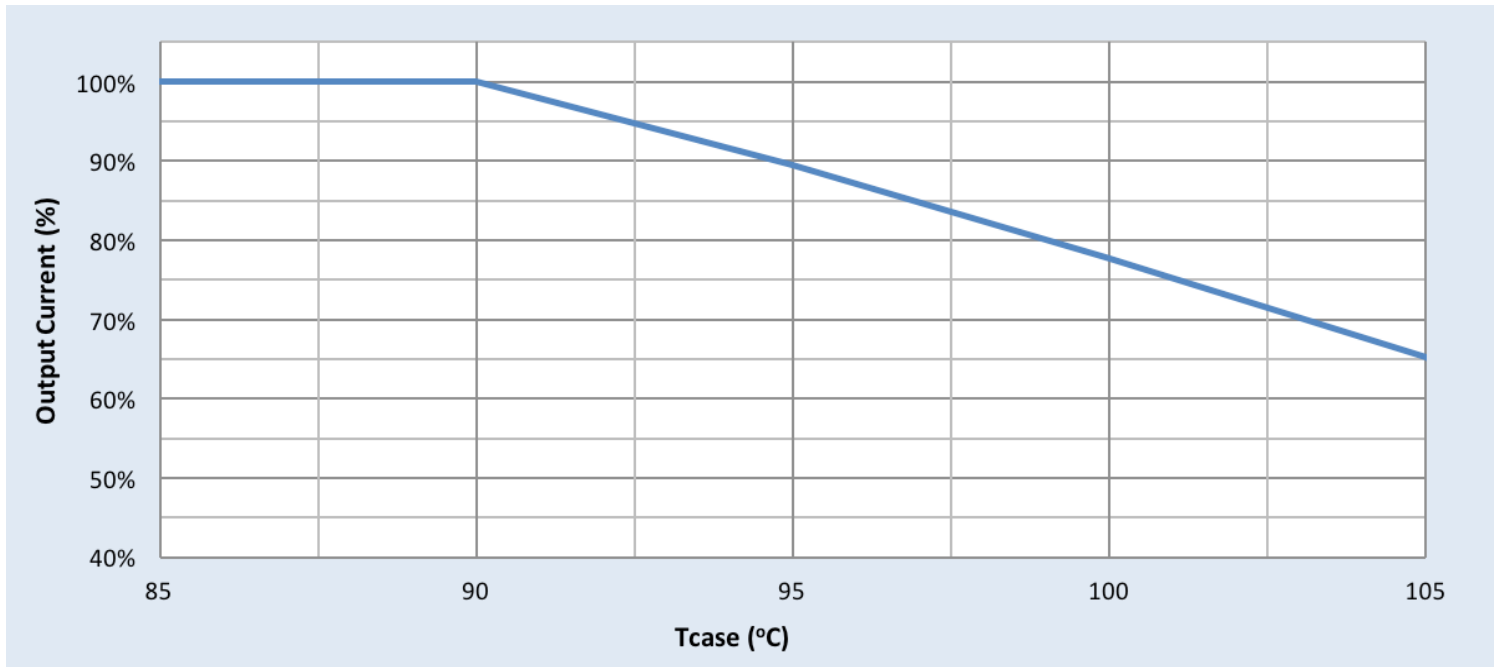

Note

There is $\pm 5^\circ\text{C}$ tolerance on the driver case temperature.

Driver Lifetime Vs. Driver Case Temperature

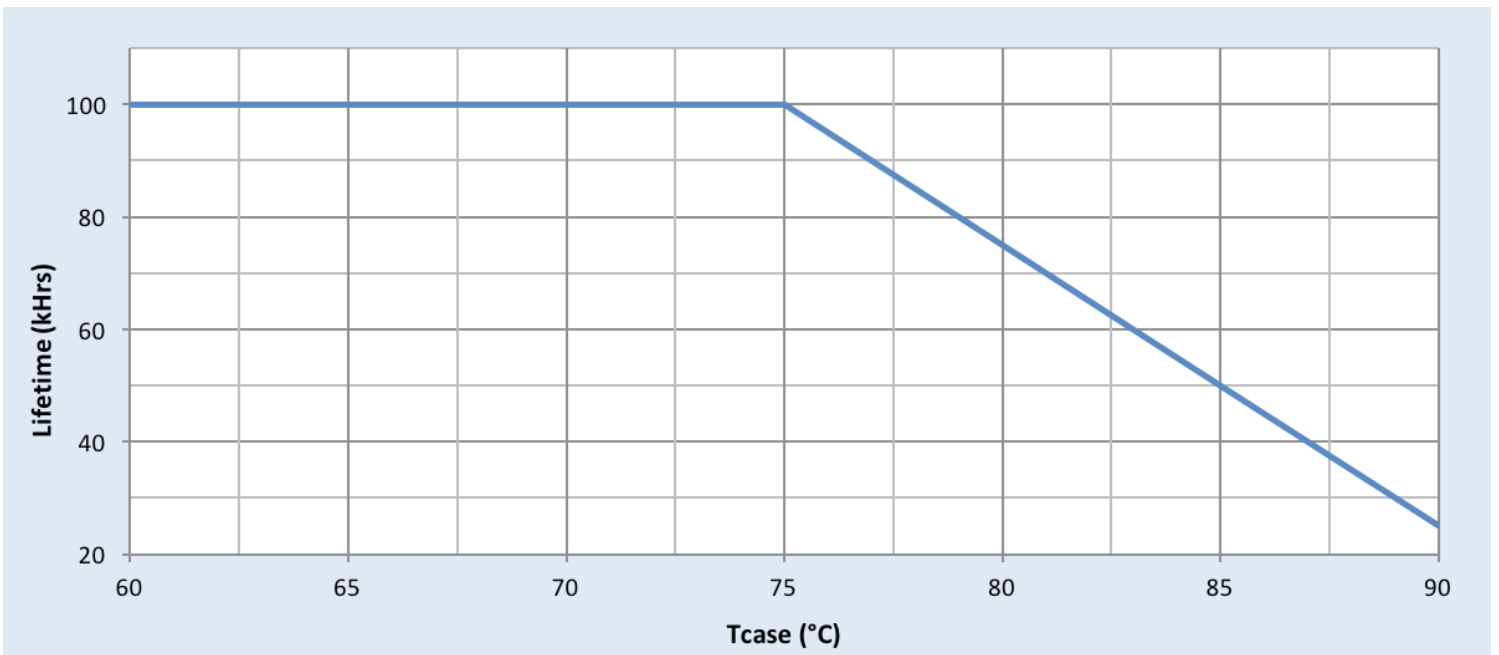

Xitanium 220W 347-480V 1.05A 0-10V dimming

Performance Characteristics

Based on measurements on a typical sample at 75°C case. The accuracy of the measurements is within the tolerance of the measurement instruments.

Efficiency Vs. Output Voltage

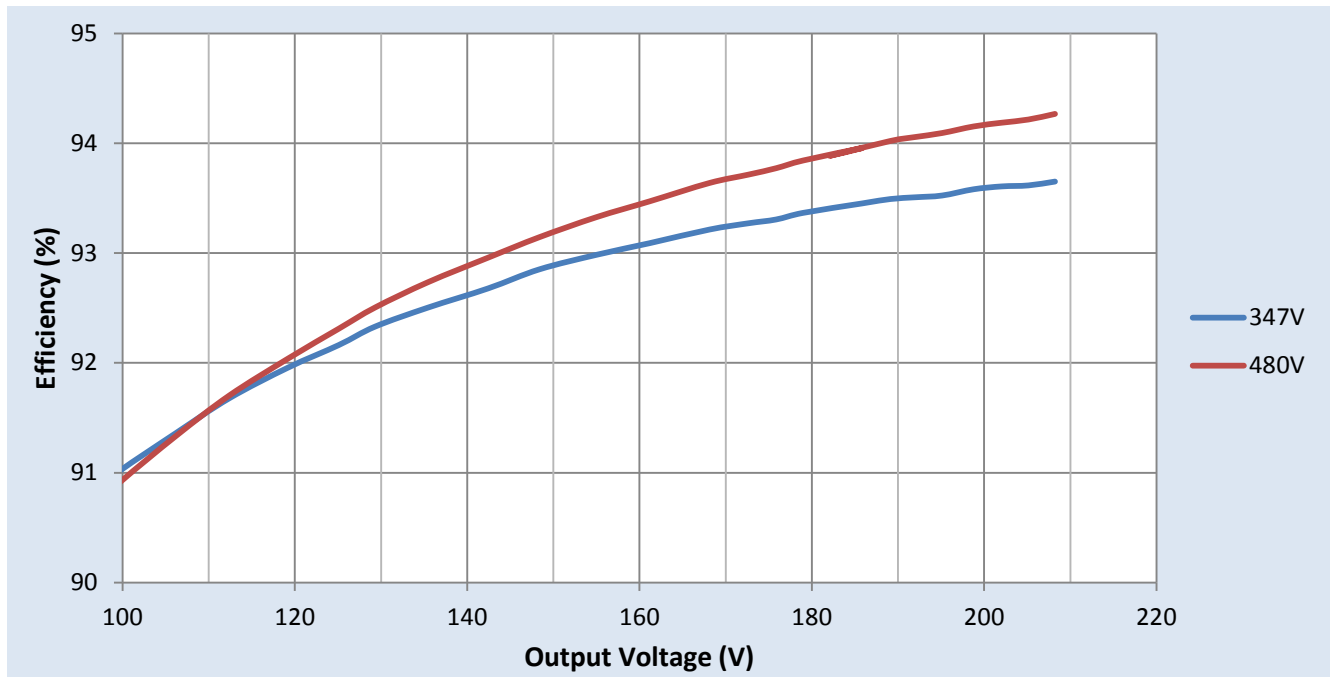

Xitanium 220W 347-480V 1.05A 0-10V dimming

Performance Characteristics

Based on measurements on a typical sample at 75°C case. The accuracy of the measurements is within the tolerance of the measurement instruments.

Power Factor Vs. Output Power

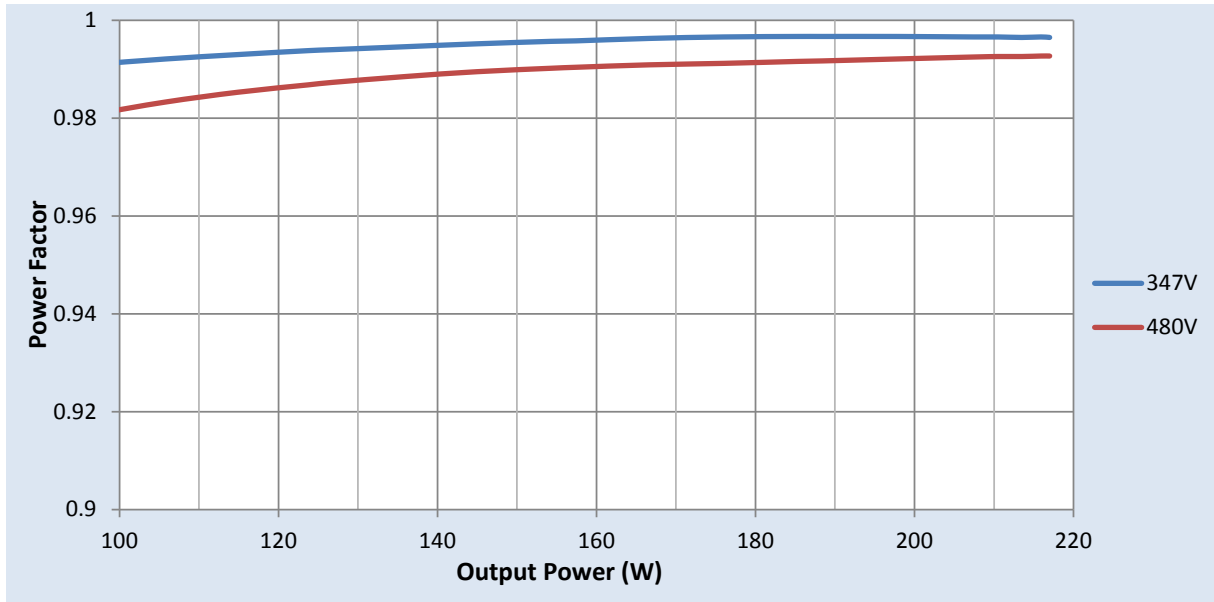

Total Harmonic Distortion (THD) Vs. Output Power

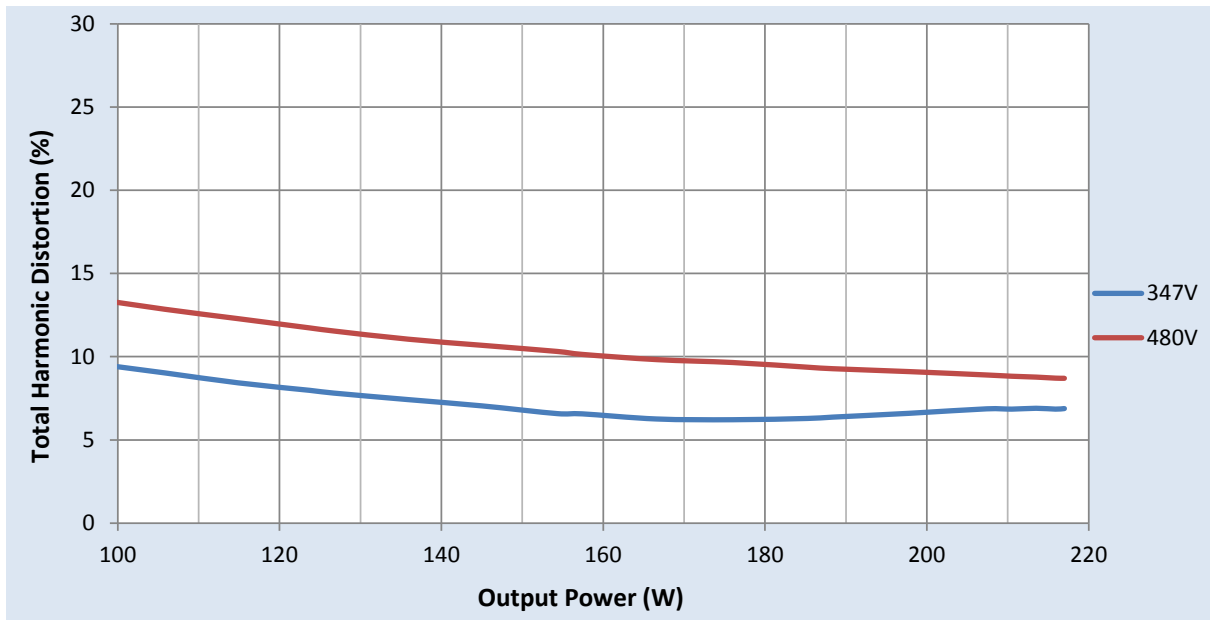

Xitanium 220W 347-480V 1.05A 0-10V dimming

Inrush Current Info

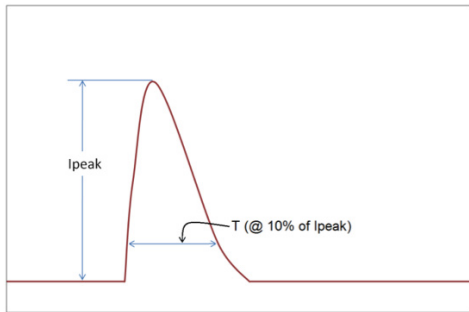

Vin	Ipeak	T (@ 10% of Ipeak)
347 Vac	64A	195µs
480 Vac	97A	190µs

Inrush current is measured at peak of the corresponding line voltage, source impedance per NEMA 410.

Lightning Surge Info

ANSI Surge Type	Differential Mode (L-N)	Common Mode (L-G, N-G, L&N-G)
1.2/50µs Combination Wave (w/t 2Ω)	6kV	6kV

Isolation

Isolation	Input	Output	0-10V (Class 1 & 2)	Enclosure
Input	NA	2xU+1kV	2.5KVac	2xU+1kV
Output	2xU+1kV	NA	2.5KVac	2xU+1kV
0-10V (Class 1 & 2)	2.5KVac	2.5KVac	NA	2xU+1kV
Enclosure	2xU+1kV	2xU+1kV	2xU+1kV	NA

U = Max. input voltage

© 2017 Koninklijke Philips N.V. All rights reserved.
 Philips reserves the right to make changes in specifications and/or to discontinue any product at any time without notice or obligation and will not be liable for any consequences resulting from the use of this publication.
philips.com/leddrivers



Philips Lighting North America Corporation
 10275 W. Higgins Road, Rosemont IL 60018
 Tel: 800-322-2086 Fax: 888-423-1882
 Customer/Technical Service: 800-372-3331
 OEM Support: 866-915-5886

Philips Lighting Canada Ltd.
 281 Hillmount Rd, Markham, ON, Canada L6C 2S3
 Tel. 800-668-9008