

**PHILIPS  
ADVANCE**

**LED Driver**

**Xitanium**

100W 0.1-1.1A 0-10V  
with SimpleSet  
XI100C110V143BSY1



Philips Advance Xitanium outdoor LED drivers with SimpleSet technology are designed to give OEMs ultimate flexibility. With the drivers' wide operating windows and simple programming, luminaire manufacturers can design luminaires of different sizes and lumen levels for outdoor applications.

**Specifications**

Input Voltage (Vac)	Output Power (W)	Output Voltage (V)	Output Current (A)	Efficiency@ Max Load and 70°C Case	Max Case Temp. (°C)	Input Current (A)	Max. Input Power (W)	THD @ Max Load (%)	Power Factor @ Max Load	Surge Protection (Combi-Wave, KV)	Envir. Protection Rating
120	100	48-143	0.1 - 1.1	89.5	85°C	0.94	114	<10%	>0.95	6	UL damp & dry and Type HL
277				91.2		0.42		<15%			

**Enclosure**

	In. (mm)
Case Length	5.43 (138.00)
Case Width	2.32 (59.00)
Case Height	1.50 (38.00)
Mounting Length	5.98 (152.00)
Overall Length	6.61 (168.00)

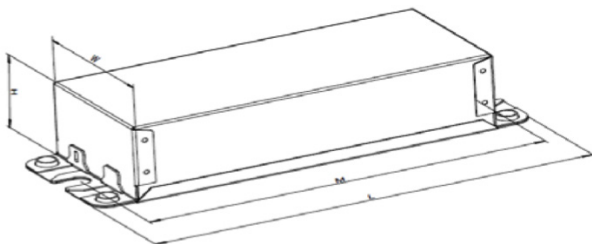

**Wiring Diagram**

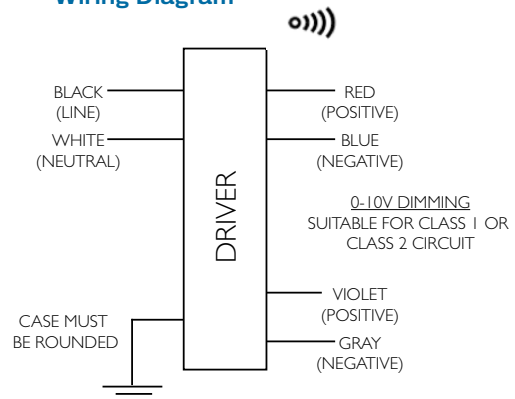

Dimming	Dimming Range (with specified dimmers)	Minimum Output Current (A)
0-10V Analog Class 1 and 2 Wiring	10% ~ 100%	0.03

# Xitanium 100W 0.1-1.1A 0-10V with SimpleSet

## Features

- 50,000+ hour lifetime<sup>1</sup>
- Programmable output current through SimpleSet
- Large operating window
- 6kV Combi-wave surge rating to comply with ANSI C82.77-5 CAT C low

## Benefits

- Enables long life luminaire designs
- Fast and simple way of programming
- Enables fixture designs with wide variety of loads and adjustable current options
- No external surge protection required to pass C82.77-5 CAT C low

## Application

- Area
- Roadway
- Parking garages
- Floodlights

## Electrical Specifications

All the specifications are typical and at 25°C Tcase unless specified otherwise.

## Product Data

Order Information	
Full Product Code	XI100C110V143DSY1M (Mid-Pack, 12pcs/Box)
Line Frequency	50/60Hz
Min. Mains Voltage Operational	108 Vac
Max. Mains Voltage Operational	305 Vac
Output Information	
Maximum Open Circuit Voltage	190Vdc
Output Current Ripple (ripple = peak to average / average)	15% max @ max Iout
Output Current Tolerance (In the performance window)	<5%
Protections	Short Circuit, Open Circuit Protection for LED + and LED -
Features	
0-10V Dimming	150µA (±3%) source current from driver. See dim curve for detail
AOC (Adjustable Output Current)	0.1A-1.1A via SimpleSet (Factory Default at 1.05A)
Additional SimpleSet Configurable Features	Adjustable Min Dim level, Adjustable Lumen Output, Adjustable Lumen Output Min, OEM Write Protection
Environment & Approbation	
Operating Ambient Temp. Range	-40°C to +55°C
Max Case Temperature (Tcase)	85°C
Agency Approbations	UL 8750, CSA 250.13
Electromagnetic Compliance	FCC Title 47 Part 15 Class A
Audible Noise	<24dB Class A
Weight	1.44 Lbs / 0.65 kgs

1. Philips Advance Xitanium LED Drivers are manufactured to engineering standards correlating to a designed and average life expectancy of 50,000 hours of operation at maximum rated case temperature. Minimum 90% survivals based on MTBF modeling.

# Xitanium 100W 0.1-1.1A 0-10V with SimpleSet

## Electrical Specifications

All the specifications are typical and at 25°C Tcase unless specified otherwise.

## 0-10V Dimming Curve

Dimming source current from the driver: 150µA (@ 0<Vdim<8V)

Minimum Dim Level: Factory default 10% of Iout (minimum 100mA), can be programmed to a higher level via SimpleSet

Maximum output voltage on the dimming wires: 12V

## Approved Dimmer List

Manufacturer	Manufacturer Part Number
Lutron	Visit <a href="http://www.lutron.com/advance">www.lutron.com/advance</a> for a list of dimmers (Mark VII) that will work with this driver
Leviton	IllumaTech IP7 series
Philips	Sunrise - SR1200ZTUNV

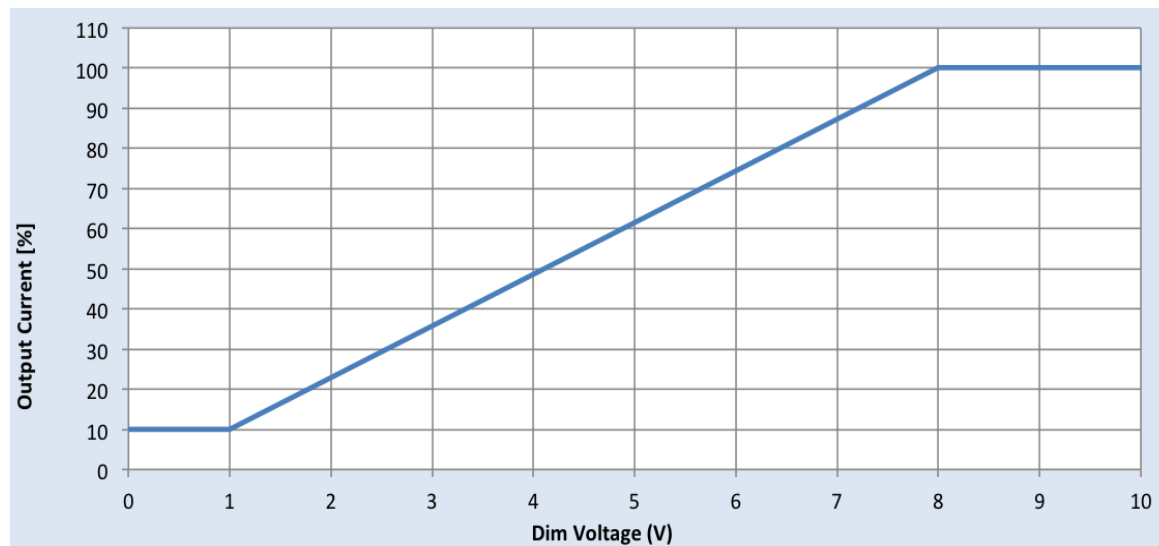

# Xitanium 100W 0.1-1.1A 0-10V with SimpleSet

## Electrical Specifications

All the specifications are typical and at 25°C Tcase unless specified otherwise.

## Driver Output Window

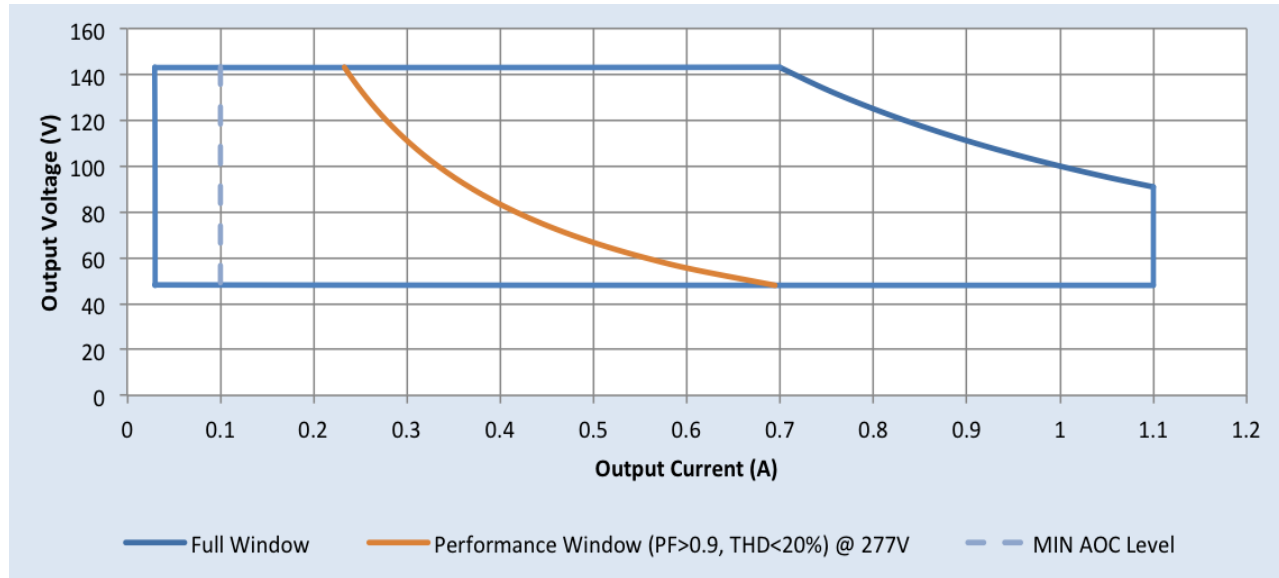

## Notes

1. Factory default output current is 1.1A.
2. To get a 100% to 10% dimming range, the output current setting through AOC should be > 0.3A.

# Xitanium 100W 0.1-1.1A 0-10V with SimpleSet

## Electrical Specifications

All the specifications are typical and at 25°C Tcase unless specified otherwise.

### Output Current Vs. Driver Case Temperature

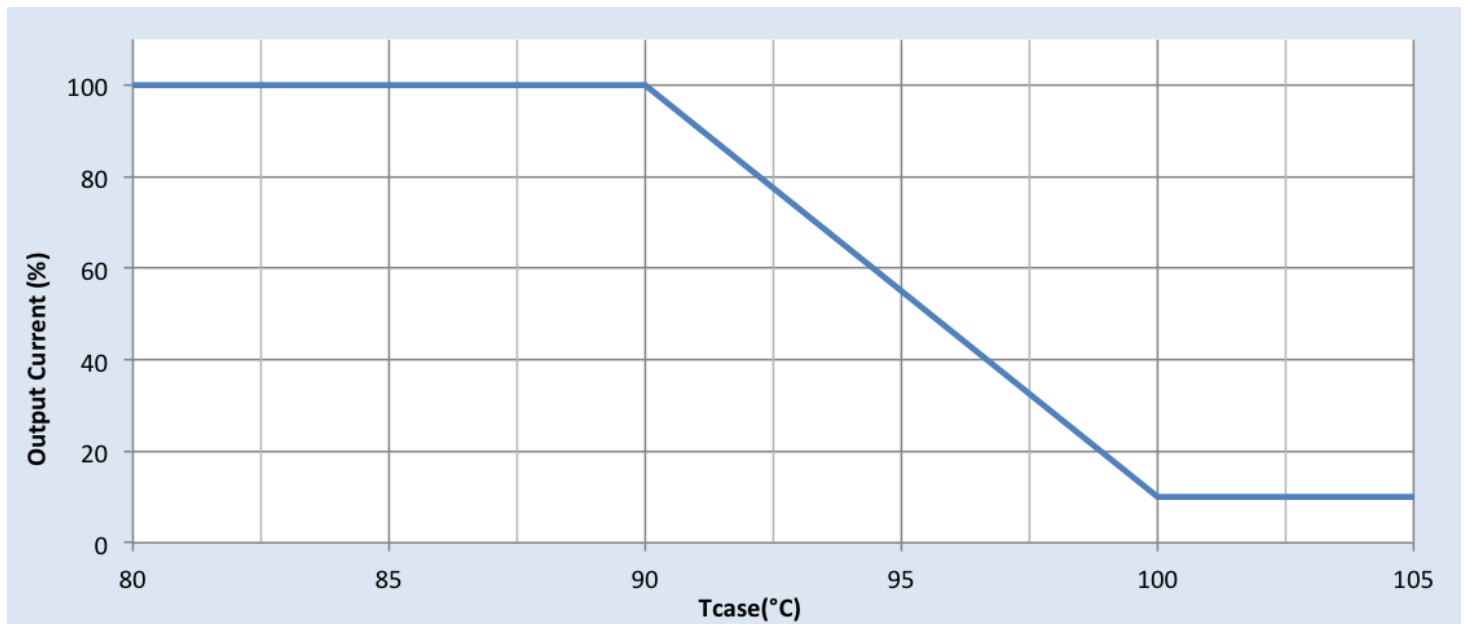

#### Note

There is  $\pm 5^\circ\text{C}$  tolerance on the driver case temperature

### Driver Lifetime vs. Driver Case Temperature

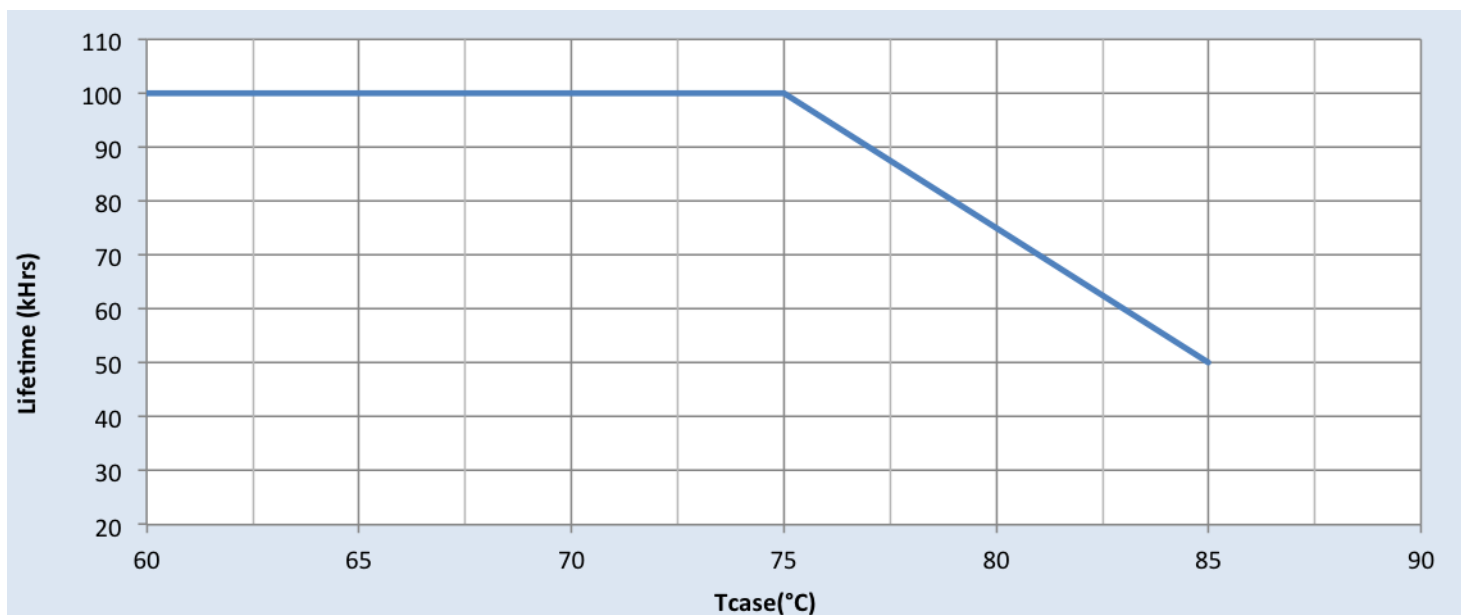

# Xitanium 100W 0.1-1.1A 0-10V with SimpleSet

## Performance Characteristics

Based on measurements on a typical sample at 75°C Case. The accuracy of the measurements is within the tolerance of the measurement instruments.

### Efficiency Vs. Output voltage at 120Vac

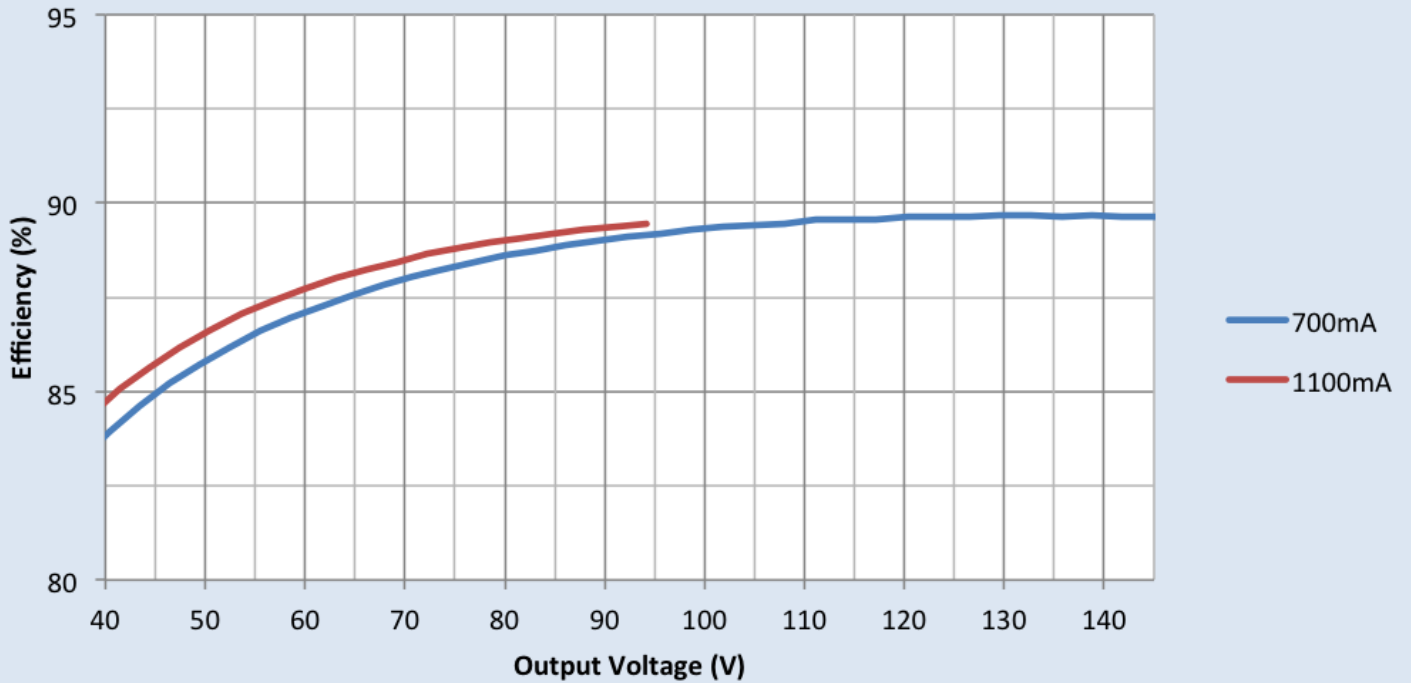

### Efficiency Vs. Output Voltage at 277Vac

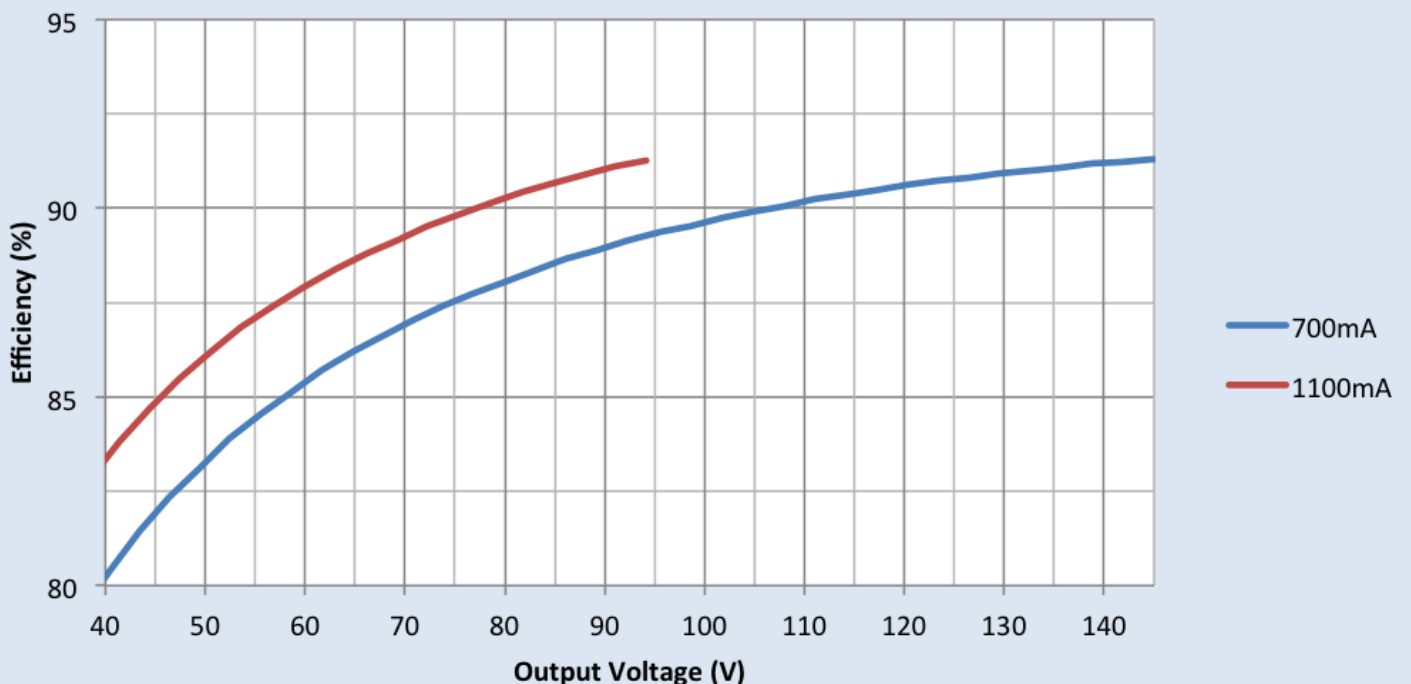

# Xitanium 100W 0.1-1.1A 0-10V with SimpleSet

## Performance Characteristics

Based on measurements on a typical sample at 75°C Case. The accuracy of the measurements is within the tolerance of the measurement instruments.

### Power Factor Vs. Output Power

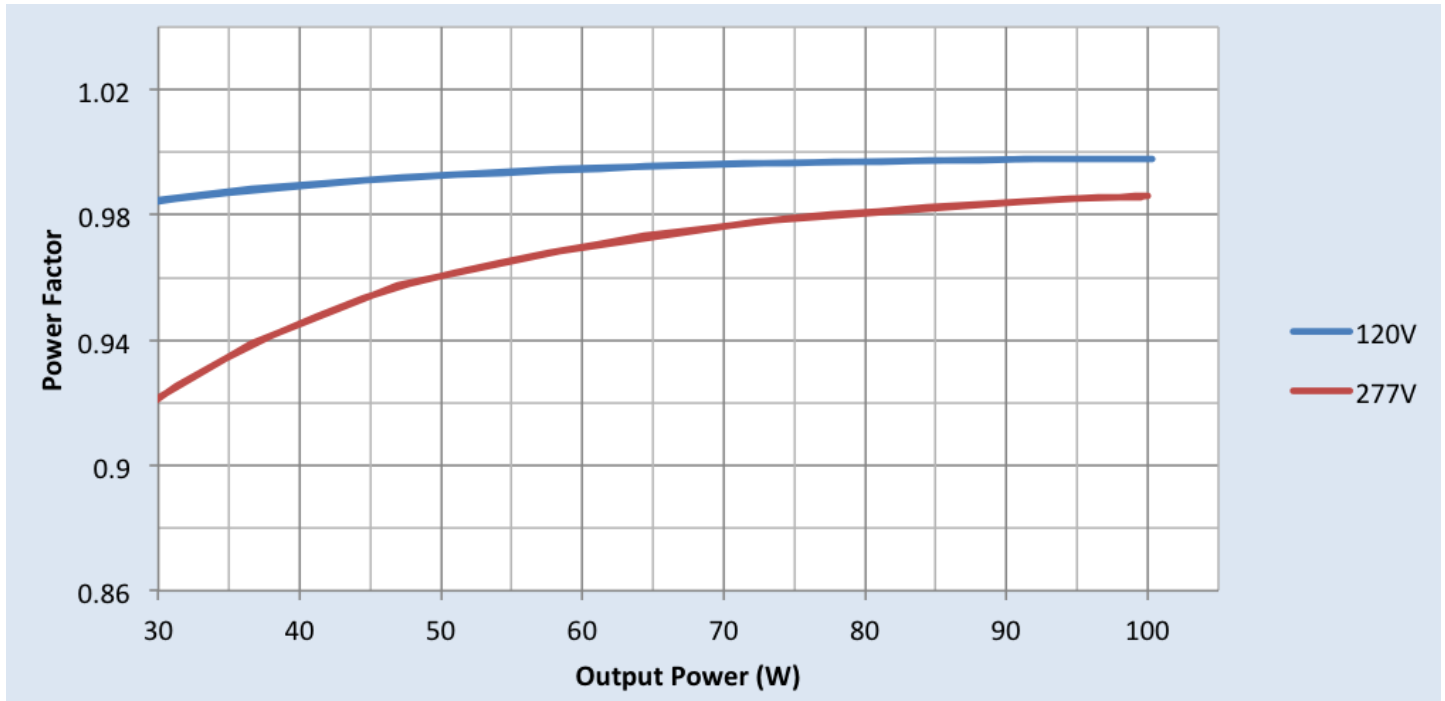

### Total Harmonic Distortion (THD) Vs. Output Power

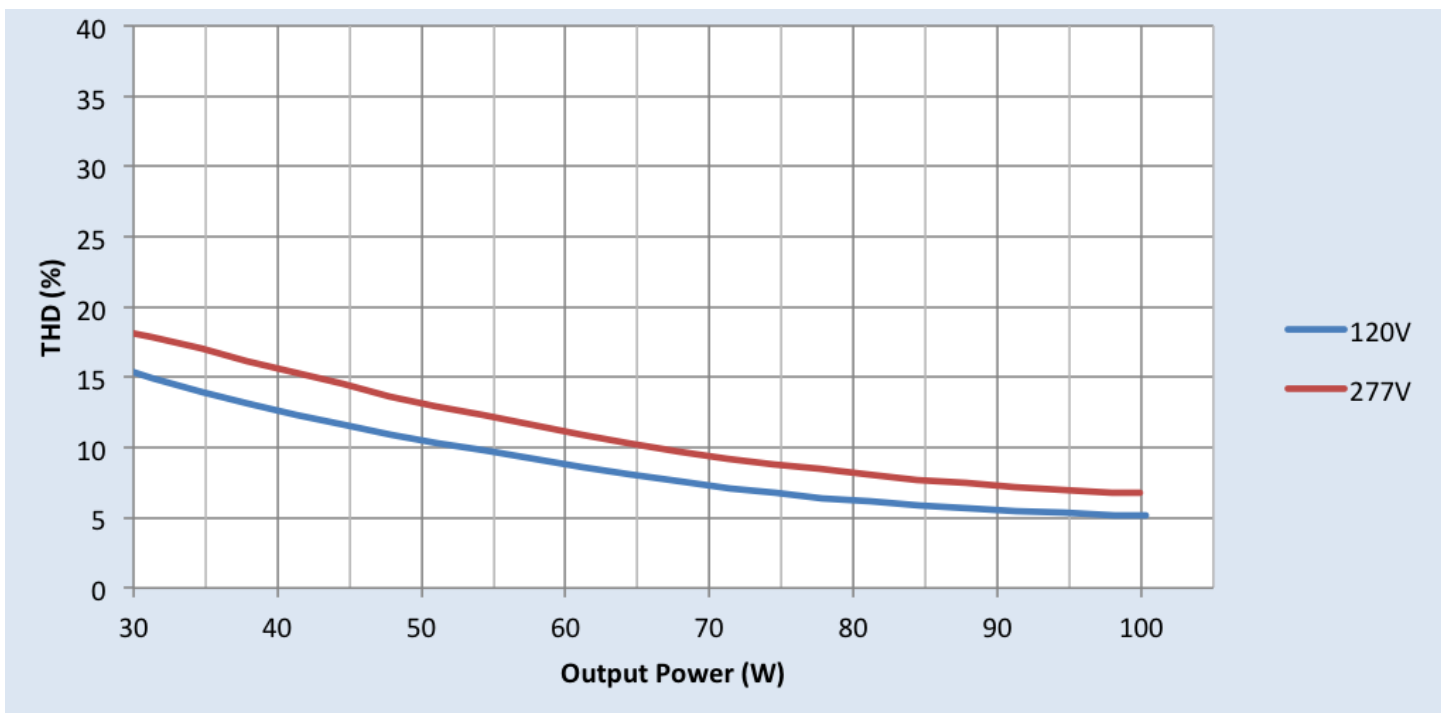

# Xitanium 100W 0.1-1.1A 0-10V with SimpleSet

## Inrush Current Info

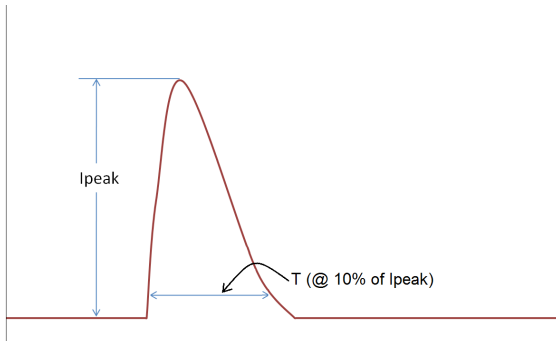

V <sub>in</sub>	I <sub>peak</sub>	T (@ 10% of I <sub>peak</sub> )
120 Vrms	57A	166μS
277 Vrms	135A	160μS

Inrush current is measured at peak of the corresponding line voltage. Source impedance per NEMA 410.

## Lightning Surge Info

ANSI Surge Type	Differential Mode (L-N)	Common Mode (L-G, N-G, L&N-G)
1.2/50μs Combination Wave (w/t 2Ω)	6kV	6kV

## Isolation

Isolation	Input	Output	0-10V	Enclosure
Input	NA	2xU+1kV	2.5kV	2xU+1kV
Output	2xU+1kV	NA	2.5kV	2xU+1kV
0-10V	2.5kV	2.5kV	NA	2.5kV
Enclosure	2xU+1kV	2xU+1kV	2.5kV	NA

U = Max input voltage

## UL Conditions of Acceptability

Please contact your Philips representative for a copy of the latest UL Conditions of Acceptability (COA).

© 2015 Koninklijke Philips N.V. All rights reserved.  
Philips reserves the right to make changes in specifications and/or to discontinue any product at any time without notice or obligation and will not be liable for any consequences resulting from the use of this publication.  
philips.com/leddrivers



Philips Lighting North America Corporation  
10275 W. Higgins Road, Rosemont IL 60018  
Tel: 800-322-2086 Fax: 888-423-1882  
Customer/Technical Service: 800-372-3331  
OEM Support: 866-915-5886

Imported by: Philips Lighting  
A division of Philips Electronics Ltd.  
281 Hillmount Rd, Markham, ON, Canada L6C 2S3  
Tel. 800-668-9008