

PHILIPS

LED Modules

Design-in Guide

Fortimo LLS
EaseSelect



Simply innovative **integration**

Contents

| | | | |
|--|----|--|----|
| Introduction to this guide | 3 | Quality, compliance and approval | 22 |
| Information or support | 3 | Chemical compatibility | 22 |
| Application note | 3 | Compliance and approval marks | 23 |
| Warnings and instructions | 4 | Ingress protection – IP rating, humidity | |
| Cautions during storage and transportation | 5 | and condensation | 23 |
| Electrical design-in | 6 | Blue light hazard | 24 |
| Mechanical design-in | 8 | System disposal | 25 |
| System assembly instruction | 8 | Relevant standards | 25 |
| Assembly in a fixture | 12 | Safety | 25 |
| Wires and connectors | 15 | Electromagnetic compatibility | 25 |
| Optical design-in | 16 | Environmental | 25 |
| Light distribution | 16 | Contact details and suggested suppliers | 26 |
| Ray sets | 16 | Philips Fortimo LED linear systems | 26 |
| Color consistency (SDCM) | 17 | Philips PInS ESD support | 26 |
| Spectral light distribution | 17 | ESD-related material and tool suppliers | 26 |
| Reflector design | 18 | Disclaimer | 27 |
| Thermal design-in | 18 | | |
| Reliability | 19 | | |
| Impact of thermal cycling on product failure | 19 | | |
| Lumen maintenance of the Fortimo LED | | | |
| linear modules B50L70 @ 50,000 hours | 20 | | |
| LM-80 data and DLC compliance | 20 | | |
| Lumen maintenance for different | | | |
| Tc temperatures | 21 | | |

Introduction to this guide

This guide contains information to help you design Philips Fortimo LLS EaseSelect low voltage (LV) product into a luminaire. We advise you to consult our website for the latest up-to-date information.

Information or support

If you require any further information or support, please consult your local Philips sales representative or visit www.philips.com/oemna.

Application note

The Fortimo linear lighting system (LLS) EaseSelect (ES) is Philips' first linear integrated LED light engine solution that combines a UL Class 2 constant current LED driver and a L2 LED module into a fully optimized system.

It enables OEM fixture manufacturers to design and manufacture LED fixtures meeting minimum performance requirements optimized for most economic fixture designs.

Its patented system design provides opportunity to optimize the mechanical and electrical fixture bill of materials while delivering high quality of light and performance.

With the application of commercial LED strip and waterproof fixtures in mind, Philips has designed this economic system solution to provide added value to designers.

Long-lasting and low-maintenance, LED-based light sources are an excellent solution for indoor environments. For optimal performance, these lighting applications require a reliable power source matching the long lifetime of the LEDs. The perfectly married component choices of LED driver and LED module offer reliability and flexibility for optimal solutions in luminaire design.

Terms and definitions

In this guide, there will be references to three terms when referring to the Fortimo LLS EaseSelect product.

- | | |
|-------------|--|
| LED module: | L2 linear light engine that is comprised of PCB material, LEDs and other electrical components, such as connectors |
| LED driver: | LED Class 2 power source that transforms line voltage into DC voltage to power LED module |
| LED system: | This defines the system of LED module and LED driver as an assembled system |

Commercial naming of the Philips Fortimo LLS EaseSelect products

The names of Fortimo LLS EaseSelect products are defined as shown in the example below.

Fortimo LLS ES 4ft 4400lm 830 1R LV1 36W INT

Fortimo: Our concept name for efficient, clear and reliable lighting

LLS: Stands for “linear lighting system”

4ft: Length of LED module

4400lm: 4400 lumen output

830: 8 denotes a color rendering index of 80 (CRI divided by 10); 30 stands for a CCT of 3000 K (CCT divided by 100)

1R: Indicates the number of LED rows on a LED line, in this case 1

LV: Low voltage; indication of compliance with UL Class 2 requirements

1: Generation 1

36W: System power

INT: Driver description (e.g., INT for Intellivolt)

Warnings and instructions



Safety warnings and instructions to be taken into account during design-in and manufacturing include:

- Avoid touching live parts!
- Avoid touching any bare components on the PCB, e.g., LEDs or driver components!
- Luminaires must be installed and grounded in accordance with national and local electrical codes!
- To avoid any mechanical damage to the PCB or components of the LED module, appropriate jig is required to hold the LED module in place during the assembly process.
- Do not use damaged or defective driver. Do not use damaged or defective LED modules, including damaged connectors or PCB.
- Do not drop the LED module or let any object fall onto the LED module because this may damage the PCB, LEDs and/or components. If the LED module has been dropped or an object has fallen onto the LED module, do not use it, even if there are no visible defects or signs of damage.
- The supplied LED driver should not be lifted or handled by pulling on the attached lead wires.



- The luminaire manufacturer is responsible for its own luminaire design and must comply with all relevant safety and performance standards. The general UL 1598 recommendations for luminaire design and legal safety are also applicable to Philips Fortimo LLS EaseSelect.
- Cap off all unused wires to prevent accidental contact with live terminals.
- Do take into account the minimum required creepage and clearance distances.
- Do not apply mains power to the LED module directly.
- Connect all electrical components first before switching on mains.
- Do not service the luminaire when the mains voltage is connected; this includes connecting or disconnecting the LED module's cables.
- This LED driver is not suited for DC input operation!
- The Philips Fortimo LLS EaseSelect is intended for built-in use and should not be exposed to the elements, such as snow, water or ice. It is the luminaire manufacturer's responsibility to prevent exposure. Fortimo LLS EaseSelect products are specified for UL damp and dry locations.
- For optimal reliability of the LED module, we advise not to apply an AC electric strength test to the luminaire, as this might damage the LEDs. It is recommended instead to apply an insulation resistance measurement at 500 VDC.
- For support with any of these aspects, please contact your local Philips sales representative.

Cautions during storage and transportation

When storing this product for a long time (more than one week)

- Store in a dark place. Do not expose to direct sunlight.
- For Philips LED linear modules, do maintain temperature and relative humidity between specified range as stated in the respective datasheets (www.philips.com/oemna).

Electrical design-in

Intended released combinations of LED modules and LED drivers are depicted in the respective datasheet, to be downloaded from the website, www.philips.com/oemna. Information on wiring the system can be found in the Mechanical design-in chapter, pages 8-15.



Warnings

Note that the LED driver and LED module supplied as the two parts of this system must be used together to create a single Philips Fortimo LLS EaseSelect LED system. Only the specified combinations of driver and module can be combined together to create LLS EaseSelect product and maintain approbation in line with UL 8750. Please refer to the product datasheet for approved combinations.

Attention

- First compose, wire and secure the system components before connecting to or switching ON the mains.
- UL classification of the system and IP rating need to be handled by the OEM.
- The Philips Fortimo LLS EaseSelect product itself does not require any protective earth connection, but please note that luminaires need to be installed and grounded in accordance with national and local electrical codes.

Insulation safety

60V is the highest voltage that may occur across any insulation of the module without compromising the safety of the module. Please refer to the Output Safety Level found in the Electrical Specifications of LED Driver section in the datasheet.

Cables and wires

With the current Philips LED linear modules both stranded and standard solid core installation wire can be used. This approach allows the OEM to choose the preferred supplier, as well as preferred cable properties like color, thickness and lengths, although mains-rated wiring is advised. Please check the datasheet for details like wire thickness and strip length on www.philips.com/oemna.

Mains voltage fluctuations and behavior

The supplied driver is able to withstand high and low mains voltages for limited periods of time. Operating outside this range will stress the driver and LEDs, which in turn will have an adverse effect on their lifetime. See the associated datasheets for specific values.

Leakage current

Philips Fortimo LLS EaseSelect products are designed to meet leakage current requirements per UL 8750 standards. In a luminaire, leakage current may be higher since the LED load introduces additional parasitic capacitance. As such, precautions should be taken at the luminaire level and also if multiple products are used in the luminaire.

Surge protection

Note: Please consult the fuse and circuit breaker manufacturer recommendations when selecting appropriate fuse and/or circuit breakers in conjunction with LED luminaires.

Philips Fortimo LLS EaseSelect products have limited built-in surge protection (in accordance with IEEE /ANSIC82.77-5 Transient Surge Requirements). Additional protection against excessive high surges can be achieved by adding a surge protection device. The actual limit can differ per product and can be found in the product's datasheet on www.philips.com/oemna.

Inrush current

Inrush current refers to the brief high-input current that flows into the driver during the initial start-up to charge the capacitors on the input side. Typically, the amplitude is much greater than the operating or steady-state current, as illustrated in Figure 1.

Philips Fortimo LLS EaseSelect products meet the inrush specification values per NEMA 410. The peak and duration values are given in the individual product datasheet.

High inrush currents can cause circuit breakers or fuses to open if not designed to handle this current. It can limit how many drivers can be connected to a circuit breaker (CB) or fuse.

The best way to reduce inrush is to turn on relays or switches at the zero crossing of the mains. Many controllers do this to reduce the large inrush currents.

Electromagnetic compatibility (EMC)

Philips Fortimo LLS EaseSelect products are designed to meet EMC requirements per FCC Title 47 Part 15 Class A. Compliance to this standard means our products are suitable for commercial and industrial lighting applications.

The product does not have a ground connector or wire. It is designed to fulfill EMC requirements in both grounded and ungrounded fixtures.

Note: Luminaires must be installed and grounded in accordance with national and local electrical codes.

Electrical isolation

The supplied LED driver's output (secondary) is isolated from the input (primary) for providing isolated Class 2 output to LED module.

The plastic cover of the driver unit also provides isolation between all the electronic circuits inside the driver and the luminaire. The bottom part of the driver needs to be covered by the LED board to provide required isolation barrier.

Product is designed to meet the UL 8750 safety standard. Included Class 2 driver is also designed to meet UL 1310 Class 2 safety standard.

All of the wires in the products are designed to meet the UL 1452 safety standards.

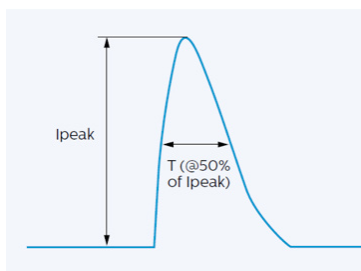

Figure 1. Inrush current.

Mechanical design-in

The Fortimo LLS EaseSelect is a system that needs to be composed of a LED module (Fortimo LLS ES) and a compatible LED driver.

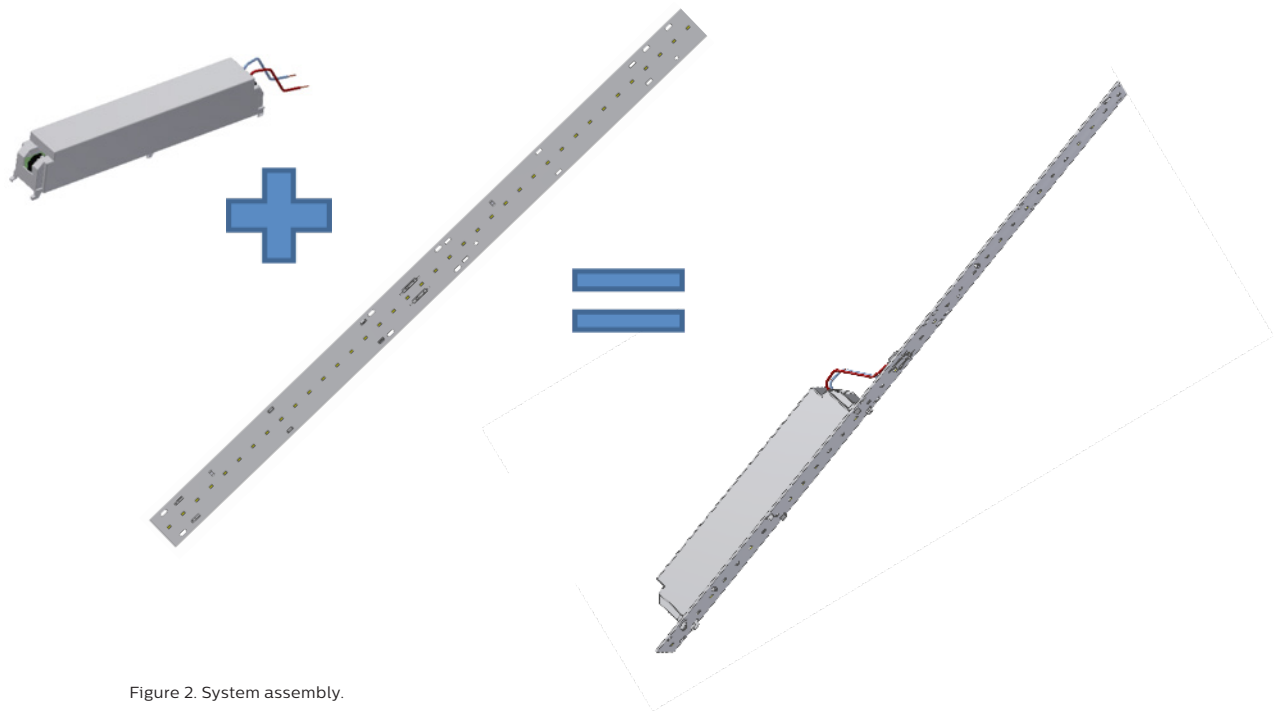

Figure 2. System assembly.

System assembly instruction

Caution:

Do not handle the LED driver by the output wires or pull on the wires! Doing so will damage the connector and electrical connection.

Do not touch the LEDs!

The module shall be handled in a way that maintains flatness and prevents excessive flexing during the assembly process. To avoid any mechanical damage to the PCB or components of the LED module, an appropriate jig is required to hold the LED module in place during the assembly process.

The driver is mechanically secured to the backside of the LED module (the side where no LEDs are located). There can be multiple mounting positions for the driver. Please refer to the product datasheet for exact mounting positions.

The pictures below show an example of assembly for the Fortimo LLS EaseSelect 4ft 4400lm LV1 36W INT.

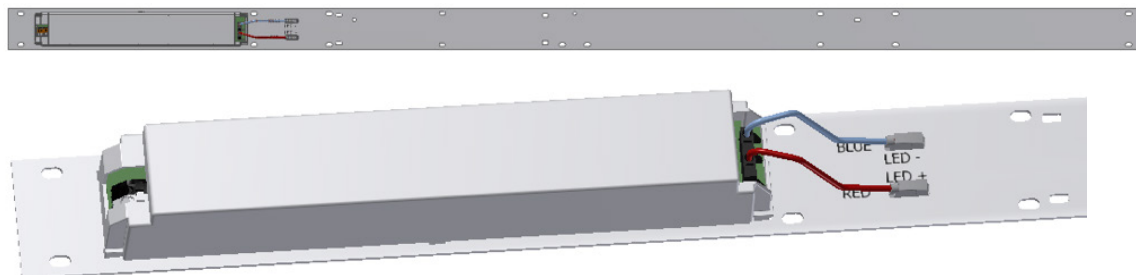

Figure 3. Position 1.

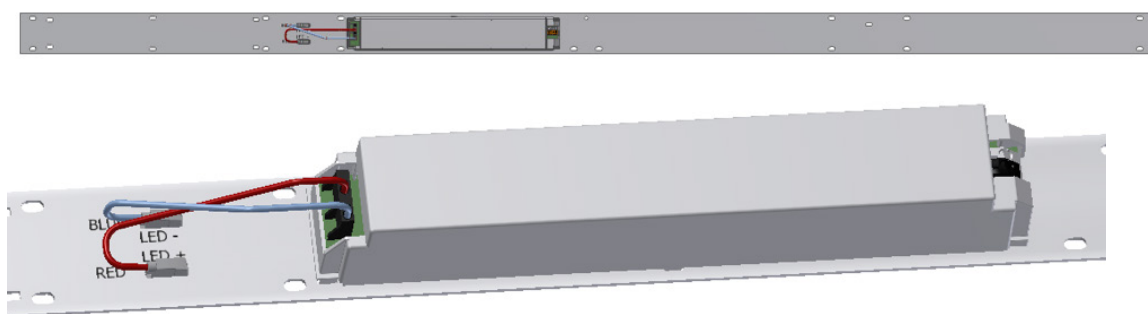

Figure 4. Position 2.

The mechanical and electrical connection between LED driver and LED module can be made in a few simple steps that are described next. Depending on the fixture design, the driver can be located either on position 1 or position 2.

Step 1: Positioning of the LED driver on the LED module

Hook-in the outer pins of the driver in the LED module.

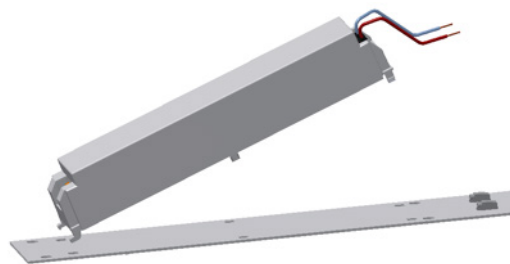

Figure 5. LED driver assembly position 1.

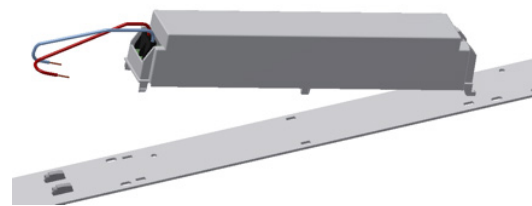

Figure 6. LED driver assembly position 2.

Step 2: Securing the LED driver on the LED module

Finish securing the driver by applying downward pressure until the four snap features click into the LED module.



Caution:

Do not touch the LEDs.

The module shall be handled in a way that maintains flatness and prevents excessive flexing.

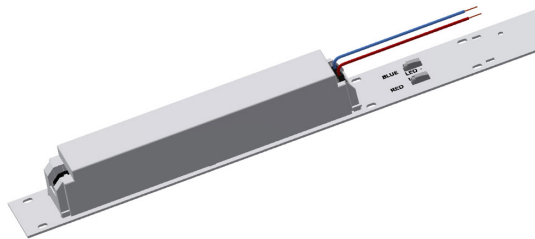

Figure 7. Position 1.

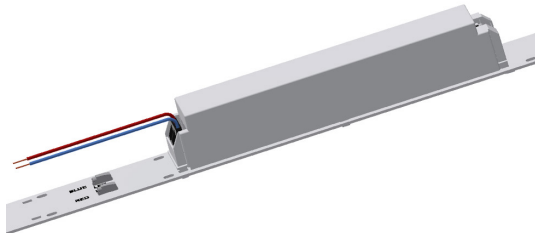

Figure 8. Position 2.

Step 3: Creating the electrical connection between LED module and LED driver

Both the LED module and LED driver are equipped with push-in connectors. No specific cabling other than standard installation wire is required. To find details of each connector, see the respective datasheet of the product you use.

Note: The LED modules are polarity-sensitive. The wiring schematic can be found toward the end of the product datasheet. Datasheets can be downloaded from www.philips.com/oemna.

Please make sure the RED (+) and BLUE (-) wires are connected to the connectors that are marked accordingly. For position 2 the output wires of the LED driver should cross each other for making the correct connection.

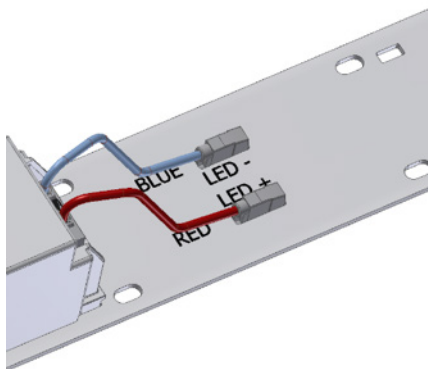

Figure 9. Electrical connection LED module and LED driver position 1.

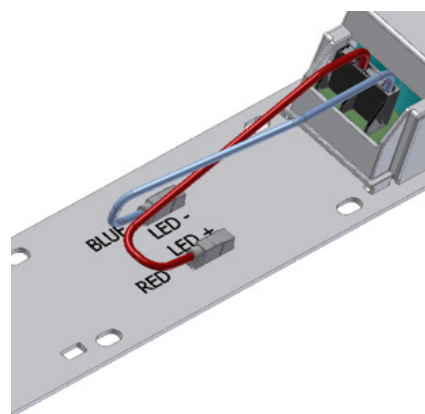

Figure 10. Electrical connection LED module and LED driver position 2.

| Wire Color | Value |
|------------|----------------------|
| Blue | LED output minus (-) |
| Red | LED output plus (+) |

Table 1. LED driver output wires.

Step 4: Creating the mains voltage connection of the LED driver

Connect external mains wires to the connector (Black = Line, White = Neutral). The LED driver does not require a functional or safety earth connection. The fixture design determines if safety earth for the fixture's metal parts is needed (responsibility of OEM customer).



Figure 11. Connect mains wires.

| Mains Connector | Value |
|-----------------|-----------------------|
| White | Neutral (mains input) |
| Black | Line (mains input) |

Table 2. Mains wires.

The mains supply has to be connected to the mains connector on the driver, not the connector on the LED board. The mains wire installation should be done in accordance with the national and local electrical codes. Please refer to the datasheet for strip length and wire diameters.

Assembly in a fixture

The LED module can be mounted in a fixture where the PCB of the LED module can act as (part) of the UL electrical and fire enclosure. Please refer to UL conditions of acceptability (CoA) for additional details.

Securing and mounting methods

With the Philips Fortimo LLS EaseSelect LED system, securing methods other than screws can be explored. In order to achieve this, larger copper-free isles have been designed on both edges of the LED module. Care should be taken to ensure clamping pressure on the PCB still maintains flatness of the LED linear module. Alternate style fasteners or mounting may be used as long as it is properly secured, flatness is achieved and creepage and clearances are maintained.



Fixture manufacturer must follow UL 1598 to maintain proper clearances.

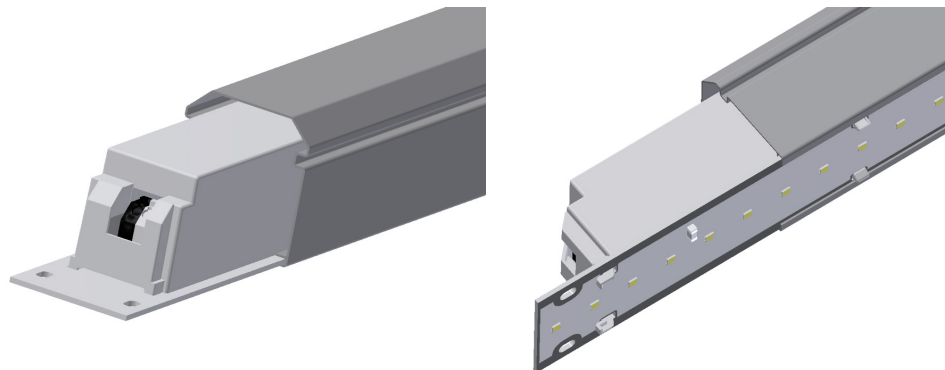

Figure 12. Mounting method without usage of screws.

Alternative mounting method

The LED module is equipped with screw holes for mounting the system into the fixture. To safeguard electrical clearance M3 or #4 screws with a maximum head diameter of 7mm should be used.

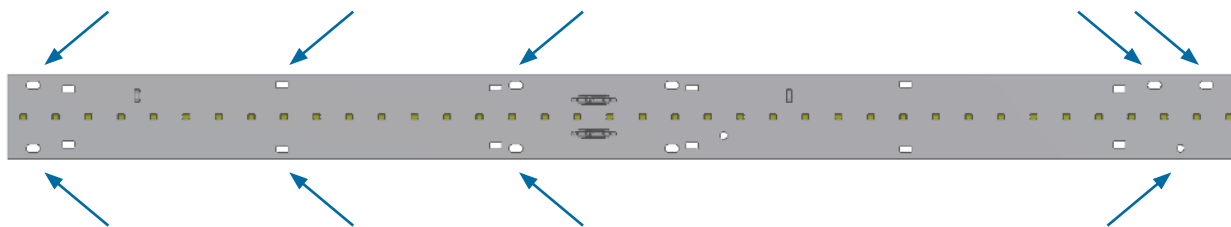

Figure 13. Screw mounting position.

The arrows indicate the holes that are intended as screw holes. The arrow indicates a fixation (screw) hole. The picture shows only half of the LED module. For the remaining mounting holes this picture can be mirrored.

Securing the module

Optionally, you can omit some mounting points as long as the module is properly secured and flatness is maintained. No additional heat sinking is required. However, this must be verified by measuring the Tc temperature of the driver and module.

Screws, washers and mounting holes

To ensure the electrical insulation when using, for example, M3 or #4 metal screws, the diameter of the screw head (and optional metal washer) must not exceed 7mm in order to maintain proper clearance to avoid functional damage to the LED module. When using electrically non-conductive materials the size could be allowed larger than that.

Damage of insulation layer

In general, the surface of the PCB must not be damaged by mounting materials, as this may compromise the electrical insulating layer. However, scratching of the PCB's white top layer in the region that is intended for fixation by screw will not lead to loss of function or reliability. The area around fixation holes does not carry any copper tracks. This can be seen when looking carefully at the LED module. The mounting materials must still comply with the relevant creepage and clearance.

Screw torque

The maximum torque that should be applied depends on the screw type and luminaire material. The fasteners used to secure the LED module to a heat sink must be tightened with a torque in accordance with the table below for an M3 or #4 screw.

Note: When tightening the fasteners it is best to start the fasteners into the module to allow the module to be centered and then tighten the fasteners from the center of the module to the ends of the module. This will help to ensure that the module will lie flat on the mounting surface and minimize any gaps that may occur.

| Fixture Material | Screw Torque for M3 or #4 Screw Max |
|------------------------------|-------------------------------------|
| Steel, thread forming screws | 0.8 Nm |

Table 3. Maximum screw torque.



Warning

If a luminaire requires protective earth, all conductive parts – like the reflector – must be electrically connected to protective earth in order to **prevent hazardous conditions**.

Required minimum clearance distance

Depending the maximum driver output voltages that can occur under normal working conditions, UL 840 prescribes minimum clearance distances.

Wires and connectors

Removal of RED (+) and BLUE (-) wires from connector can be released without tools by simultaneously twisting and pulling the wire.

Removal of the mains wires can be released from the connector by pushing the release button.

All wires must be fully inserted such that the wire insulation is inserted into and surrounded by the end of the housing (no bare wire should be visible).

Complementary partners for fixation alternatives

Fixation materials, such as screws, are not part of the Philips Fortimo LLS EaseSelect LED system offering. This is an added-value area for OEMs, offering the possibility to differentiate. However, there are several suppliers offering push-and-fix-like components or adhesive tapes, enabling quick and easy luminaire creation. Some of these are listed in the complementary partner section in our OEM LED components catalog (available in printed and digital formats) or in the support section on www.philips.com/oemna.

Reference to these products does not necessarily mean they are endorsed by Philips. Philips gives no warranties regarding these products and assumes no legal liability or responsibility for any loss or damage resulting from the use of the information given here. We advise not to use bare plastic push-pin fasteners (without any metal parts), as these are likely to wear out before the lifetime of the LED product is reached, reducing the mechanical and thermal contact between the LED module and the luminaire.

Optical design-in

Optics on top of or near the LED linear modules

Luminaire manufacturers have the freedom to design their own optics in order to maximize the lm/W efficiency and beam shape of the system.

Secondary optics is not part of the Philips Fortimo LLS EaseSelect LED system offering. This is an added-value area for OEMs, offering the possibility to differentiate. However, there are many companies offering, for example, reflectors, lenses or bulk diffusers and that have a standard portfolio of compatible optics available, enabling quick and easy luminaire creation. Some of these are listed in the complementary partner section in our LED components catalog (available in print and digital formats) or in the support section on www.usa.lighting.philips.com/products/oem-components/fortimo-led-modules. Reference to these products does not necessarily mean they are endorsed by Philips. Philips gives no warranties regarding these products and assumes no legal liability or responsibility for any loss or damage resulting from the use of the information given here.

Light distribution

Philips LED linear modules generate a Lambertian beam shape (see light distribution diagram). The IES (or .ldt) files are available via the website www.usa.lighting.philips.com/products/oem-components/fortimo-led-modules.

Ray sets

Ray set files are available for customer use and can be downloaded on www.usa.lighting.philips.com/products/oem-components/fortimo-led-modules. All ray set files are available containing 100,000, 500,000 and 5,000,000 rays, although due to their size the last two types are not on the website. Please contact your Philips representative to obtain these separately if required.

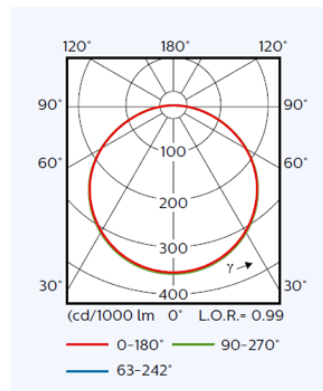

Figure 14. Light distribution.

| Software | File extension |
|---------------------------|----------------|
| ASAP | .dis |
| Light Tools (ASCII) | .ray |
| TracePro/Oslo (ASCII) | .dat |
| Zemax | .dat |
| Explanation & definitions | .ppt |
| Solid 3D model | .stp |

Table 4. Ray set zip file contains typically.

The origin of the ray sets is shown in the accompanying slide deck presentation file per module type, as are the 3D step files, on the website.

Color consistency (SDCM)

Color consistency refers to the spread in color points between modules. It is specified in SDCM (Standard Deviation of Color Matching) or MacAdam ellipses, which are identical. The value refers to the size of an ellipse around a point close to the black body locus. Staying within this ellipse results in a consistency of light, which ensures that no color difference is perceivable between one LED module and another with the naked eye in most applications.

SDCM value in the datasheet represents an integrated measurement over the complete LED module.

Please be aware that in applications that are more sensitive for color differences (color consistency of <3 SDCM), such as wall washers (<2 SDCM), we advise you to contact your local Philips representative or the Philips design-in team for expertise and support in luminaire design and evaluation.

Spectral light distribution

The typical spectral light distributions of the Philips LED modules are shown in the respective datasheets on www.philips.com/oemna.

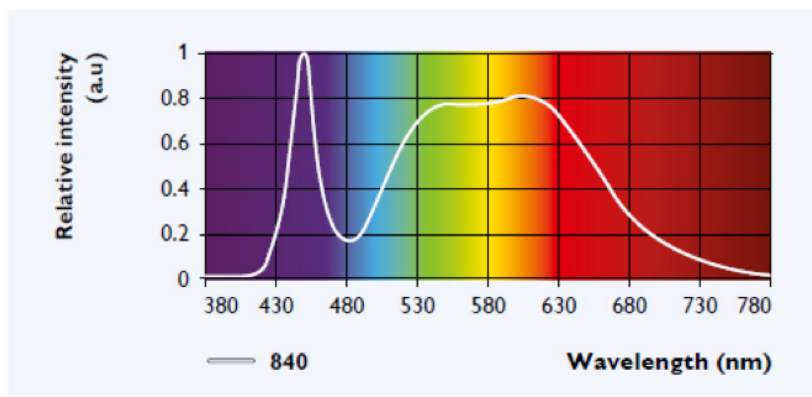

Figure 15. Example of an LED light spectrum, CCT 4000K and CRI 80 (840).

Reflector design

If a reflector is designed around the LED module, it is essential to allow a proper clearance distance between the LED module and reflector around the LED module surface, LEDs, electrical components and the connectors. This clearance distance is necessary to ensure safe insulation of the system and is in line with UL 1598 to prevent short circuiting, damage and an open circuit to the LED module.



Figure 16. Fortimo LLS ES system.

Thermal design-in

Depending on the thermal capability of the fixture, no additional heat sinking may be required. However, this must be verified by measuring the T_c temperature of the driver and module. Please refer to the datasheet for the exact location of these T_c points.

An example reference fixture is shown in Figure 18. In this fixture without additional heat sinking, T_{clife} was met up to an ambient temperature of 35°C.

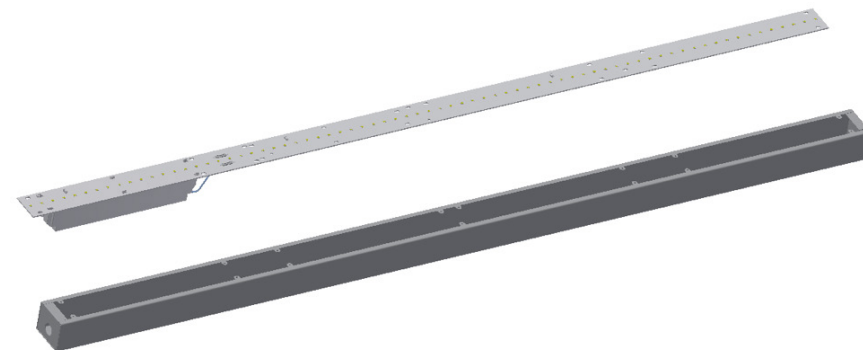

Figure 17. Reference luminaire.

Fixtures can be designed for higher ambient temperature by additional heat sinking methods. Please refer to the linear module design-in guide document (PLt-1590DG) available on the components website, www.philips.com/oemna.

Reliability

Impact of thermal cycling on product failure

Not only the drive current (mA) and steady state case temperature (Tc °C) have an impact on the lifetime of LEDs. Also the number of full thermal cycles has a significant impact on product failure. A full thermal product cycle means the complete warm up to stabilized Tc of the product in use and full cool down to ambient temperature (Tamb) of the product being switched off. For your convenience the amount of warranted full thermal product cycles of the LED product at a given Tc is stated in the datasheet, which can be found on www.philips.com/ledmodulesna. Electrically faster switching, thereby not reaching the thermal limits of a full thermal cycle, will allow for higher numbers.

Note:

Always take the Tc temperature limits into account as stated in the datasheet for the LED module you use.

Warranted number of full thermal product cycles at which the survival rate of the population ≥90%, at 25°C ambient temperature

| Case Temperature Tc [°C] | LED Module 1 | LED Module 2 |
|--------------------------|--------------|--------------|
| 35 | 14,600 | |
| 40 | | |
| 45 | 14,000 | |
| 50 | | |
| 55 | 12,000 | 14,600 |
| 60 | | |
| 65 | 8,000 | 14,600 |
| 70 | | |
| 75 | 6,000 | 14,000 |
| 80 | 6,000 | |
| 85 | | 10,000 |
| 90 | | 8,000 |

Table 5. Example: Warranted number of full thermal cycles at 25C degree ambient.

Example:

LED module 1 with Tc 65°C at Tamb 25°C has a warranted number of full thermal product cycles of 8,000.

Example:

LED module 2 with Tc 65°C at Tamb 25°C has a warranted number of full thermal product cycles of 14,600.

Lumen maintenance B50L70 @ 50,000 hours

The quality of the LED linear portfolio is underpinned with Philips' claim of B50L70 at 50,000 hours. This means that at 50,000 hours of operation at least 50% of the LED population will emit at least 70% of its original amount of lumens. The decreased lumen level can be a result of less light out of an LED, discrete LEDs failing – leading to a reduced lumen output of the luminaire – or a combination of the two. This is contrary to conventional light sources, where sometime after service life hours the conventional light source emits no light at all. In this section the example graphs show the estimated lumen depreciation curves for different percentage of the population and for different Tc temperatures. The actual data for the LED linear modules can be found in the associated datasheet.

Please refer to the associated LED module datasheet for the specific lumen maintenance graphs.

LM-80 data and DLC compliance

The DesignLights Consortium® (DLC) promotes quality, performance and energy-efficient commercial sector lighting solutions through collaboration among its federal, regional, state, utility and energy efficiency program members, luminaire manufacturers, lighting designers and other industry stakeholders throughout the U.S. and Canada. Since 2010, the DLC has administered the Commercial LED Luminaire Qualified Products List (QPL), a leading resource that identifies quality, energy-efficient LED luminaires for the commercial sector. The DLC follows the ENERGY STAR guidance for lumen maintenance testing that includes IES LM-80 test procedures and the application of LM-80 data using the IES TM-21 procedure to determine the long-term lumen maintenance of an LED light source. IES TM-21 applies an exponential least squares curve-fit through the average values provided in the LM-80 data. The TM-21 calculator that is used to determine the estimated long-term lumen maintenance can be found at the Department of Energy website. The LM-80 data for the LEDs used for each Philips LED module is available on request from your sales representative. Please contact them for assistance in obtaining this information.



Warning

Lumen maintenance of the LED device is not a proxy for luminaire lifetime as it does not account for other potential failure modes in the luminaire, such as driver failure, failure of connections, failure of optical systems, etc. Therefore, it is strongly suggested to not use TM21 predictions and calculations as the sole data point to specify luminaire lifetime.

Note:

TM21 refers to Tc sometime as the solder temperature of the LED measured in the insitu-test. This Tc is not equal to the Tc point of the Philips Fortimo LED modules that are used for thermal design-in. However, there is a clear thermal correlation between Ts and Tc designed for within any Fortimo LED module. The exact temperature difference (dT) depends on fixture design and application conditions.

Lumen maintenance for different Tc temperatures

Lumen maintenance is also affected by temperature. Lowering the Tc will increase the lumen maintenance time. The example graph below (Fig. 18) is showing the lumen maintenance (% of initial lumen over time) for B50 (50% of the population) at 1 life and three different Tc temperatures (Tc nominal, life and maximum).

Please look up the actual lumen maintenance graph in the associated datasheet of the Fortimo LED module you are using.

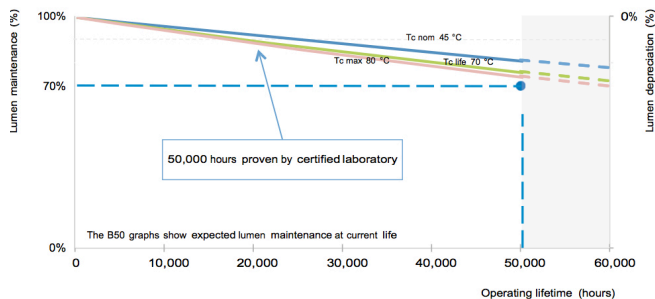

Figure 18. Lumen maintenance as a function of operating hours at different Tc values.

Note:

These graphs are lifetime predictions based on LM80 data; no warranty outside specified lifetime specifications.

Quality, compliance and approval

Chemical compatibility

In the current market, medium power LEDs exist containing a silver-finished (Ag) lead frame. The lead frame finish is sensitive to pollution and/or corrosion when exposed to oxygen and certain volatile organic components [VOCs]. Examples of VOCs are substances containing sulfur or chlorine. In that case parts of the lead frame may blacken, which will impair the lumen output or the color point of the LED light. Materials that are known to have a higher risk to be a source of sulfur and chlorine are, for example, natural rubbers used for cables, cable entries or sealing or corrugated carton. Also be careful using adhesives, cleaning agents, coatings and applications in aggressive (corrosive) environments.

We recommend ensuring that the direct environment of these LEDs in the luminaire does not contain materials that can be a source of sulfur or chlorine for optimal reliability of the LED, LED module and/or LED luminaire. Furthermore, make sure that the products with these LEDs are not stored or used in vicinity of sources of sulfur or chlorine and the production environment is also free of these materials. Also avoid cleaning of the LED products with these types of LEDs with abrasive substances, brushes or organic solvents like acetone and TCE.

Applications of the product in industry and heavy traffic environment should be avoided in case of risk of ingress of sulfur and chlorine from the environment.

| Chemical Name | Normally Used As | Chemical Name | Normally Used As |
|-------------------------------|------------------|-------------------------------|------------------|
| Acetic acid | Acid | Tetrachlorometane | Solvent |
| Hydrochloric acid | Acid | Toluene | Solvent |
| Nitric acid | Acid | Xylene | Solvent |
| Sulfuric acid | Acid | Castor oil | Oil |
| Ammonia | Alkali | Lard | Oil |
| Potassium hydroxide | Alkali | Linseed oil | Oil |
| Sodium hydroxide | Alkali | Petroleum | Oil |
| Acetone | Solvent | Silicone oil | Oil |
| Benzene | Solvent | Halogenated hydrocarbons | |
| Dichloromethane | Solvent | (containing F,Cl,Br elements) | Misc |
| Gasoline | Solvent | Rosin flux | Solder flux |
| MEK (Methyl Ethly Ketone) | Solvent | Acrylic tape | Adhesive |
| MIBK (Methyl Isobutyl Ketone) | Solvent | Cyanoacrylate | Adhesive |
| Mineral spirits (turpentine) | Solvent | | |

Table 6. Chemical compatibility.

The Philips LED linear family makes use of LEDs with previously explained type of lead frame. Therefore, the noted recommendations apply for the Fortimo LED linear modules. Philips Fortimo LED linear systems comply with the standards shown in below paragraphs.

A list of chemicals, often found in electronics and construction materials for luminaires that should be avoided, is provided in Table 13. Note that Philips does not warrant that this list is exhaustive because it is impossible to determine all chemicals that may affect LED performance. These chemicals may not be directly used in the final products, but some of them may be used in intermediate manufacturing steps (e.g., cleaning agents). Consequently, trace amounts of these chemicals may remain on (sub) components, such as heat sinks. It is recommended to take precautions when designing your application.

In case of questions on compatibility of materials or applications of the product, please contact your local Philips sales representative for application support.

Compliance and approval marks

The Fortimo LED linear family is UL/CSA approved. The relevant standards are summarized at the end of this chapter. To ensure luminaire approval, the conditions of acceptance need to be fulfilled. Details can be requested from your local sales representative. All luminaire manufacturers are advised to conform to the international standards of luminaire design (UL 1598).

Ingress protection – IP rating, humidity and condensation

Photobiological safety

The Fortimo LED Linear systems are build-in systems and, therefore, have no IP classification. They are not designed for operation in the open air. The OEM is responsible for proper IP classification and approbation of the luminaire. The Fortimo LED linear modules have been developed and released for use in damp locations and not for locations where condensation is present. If there is a possibility that condensation could come into contact with the modules, the system/luminaire builder must take precautions to prevent this.

The lamp standard IEC 62471 "Photobiological safety of lamps and lamp systems" gives guidance on evaluating the photobiological safety of lamps and lamp systems, including luminaires. It specifically defines the exposure limits, reference measurement technique and classification scheme for the evaluation and control of photobiological hazards from all electrically powered incoherent broadband sources of optical radiation, including LEDs, in the wavelength range from 200 nm to 3000 nm. Measurement results for LED products are given in Table 7. Based on these measurements, the conclusion is no safety measures are required.

| Item | Result: Risk Group |
|-----------------------|--------------------|
| Actinic UV | Exempt |
| Near-UV | Exempt |
| Retinal Blue Light | Exempt |
| Retinal Blue SmallScr | Exempt |
| Retinal thermal | Exempt |
| Infrared Eye | Exempt |

Table 7. Ingress protection – IP rating, humidity and condensation photobiological safety.

Blue light hazard

From the nature of most LEDs applying blue light, emphasis has been put on the hazard in terms of Photo Biological Safety (PBS). Evaluation by the European lighting industry (ELC, Celma) has concluded LED light sources are safe for customers when used as intended. Nevertheless, luminaire makers have to comply with luminaire standards, including PBS. To avoid extensive retesting, the market prefers to build on the test conclusions of the LED (module) suppliers. The testing conclusion then will be expressed in Risk Groups (RG), where RG0 and RG1 do not require marking and/or specific action for the OEM (as compared to RG2 and 3). The certificates with the verdict of the LED products can be found on www.philips.com/ledmodulesna.

Some facts on blue light.

- All light – visible, IR, UV – causes fading.
- It has long been known that blue light causes fading in yellow pigments.
- LEDs do not produce more blue light than other sources by its nature.
- Blue light content is relative to color temperature, not to light source.

“Often, investigations into the effect of short-wavelength radiation—be it on humans or artwork—suggest that LEDs are dangerous because they emit more blue light than other sources like incandescent bulbs or CFLs. While it is true that most LED products that emit white light include a blue LED pump, the proportion of blue light in the spectrum is not significantly higher for LEDs than it is for any other light source at the same correlated color temperature (CCT).” (Department of Energy).

For more details follow the link for the U.S. Department of Energy: http://apps1.eere.energy.gov/buildings/publications/pdfs/ssl/opticalsafety_fact-sheet.pdf.

System disposal

We recommend that the Fortimo LED modules and its components are disposed of in an appropriate way at the end of their (economic) lifetime. The modules are in effect normal pieces of electronic equipment containing components that are currently not considered to be harmful to the environment. We, therefore, recommend that these parts are disposed of as normal electronic waste, in accordance with local regulations.

Relevant standards

Safety

UL8750/CSA 22.2 250-13 modules for general lighting

- safety specifications

IEC 62471 Photobiological safety of lamps and lamp systems

UL8750/SSL 7/CSA22.2 250-13 Lamp control gear

Electromagnetic compatibility

(Tested with LED linear modules, cables and Philips Advance Xitanium LED driver).

FCC47 subpart 15 Class A Limits and methods of measurement of radio disturbance characteristics of electrical lighting and similar equipment.

FCC47 subpart 15 Class A Equipment for general lighting purposes – EMC immunity requirements.

ANSI C82.77 Limits for harmonic current emissions (equipment input current <16 A per phase).

Environmental

The product is compliant with European Directive 2002/95/EC of January 2003 on Restriction of the Use of Certain Hazardous Substances in Electrical and Electronic Equipment (RoHS).

Contact details and suggested suppliers

Philips Fortimo LED linear systems

Product information www.philips.com/ledmodulesna

Or contact your local Philips sales representative.

Philips PInS ESD support

The Philips corporate EMC competence center is a leading provider of approbation and consultancy services.

The following are suggestions of products that can be used with the Philips Fortimo LED linear system. Reference to these products does not constitute their endorsement by Philips. Philips makes no warranties regarding these products and assumes no legal liability or responsibility for loss or damage resulting from the use of the information herein.

www.innovationservices.philips.com/US

Phone:

+1 9788090483 (east coast)

+1 4154977939 (west coast)

ESD-related material and tool suppliers

| | |
|----------------------------|--|
| Amcatron Technology Co Ltd | www.amcatron.com |
| Botron Company Inc. | www.botron.com |
| Desco | www.desco.com |
| Static Solutions Inc | www.staticsolutions.com |

Table 8. ESD-related material and tool suppliers.

Disclaimer

The information in this guide is accurate at the time of writing. This guide is provided “as is” without expressed or implied warranty of any kind. Neither Philips nor its agents assume any liability for inaccuracies in this guide or losses incurred by use or misuse of the information in this guide.

Philips will not be liable for any indirect, special, incidental or consequential damages (including damages for loss of business, loss of profits or the like), whether based on breach of contract, tort (including negligence), product liability or otherwise, even if Philips or its representatives have been advised of the possibility of such damages.



© 2016 Philips Lighting Holding B.V. All rights reserved. Philips reserves the right to make changes in specifications and/or to discontinue any product at any time without notice or obligation and will not be liable for any consequences resulting from the use of this publication.

PLT-16270DG 11/16 philips.com

Philips Lighting
North America Corporation
10275 W. Higgins Road
Rosemont IL 60018
Tel: 800-322-2086
Fax: 888-423-1882
Customer/Technical Service:
800-372-3331
OEM Support: 866-915-5886

Philips Lighting Canada Ltd.
281 Hillmount Rd,
Markham, ON,
Canada L6C 2S3
Tel. 800-668-9008