



Light to go

Easy order.
Budget friendly.
Job ready.

philips.com/Lighttogo



PHILIPS

Light to go



Things just got easier. Introducing our new line up of lighting essentials – quick to order, easy on your wallet and simple to use.

Make your next lighting choice a brand you can trust. **Make it Philips Lighting.**

PHILIPS

Downlighting

Flat downlight

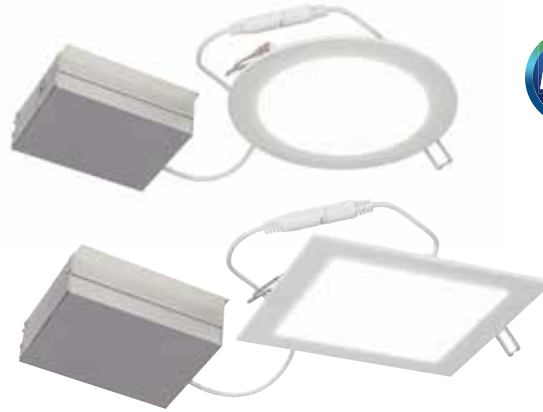

Lean,
mean,
lighting
machine

Philips Catalog Code	Size/Shape	Lumens	Color Temp	Dimming	Replaces
FDL4R07930TE1W	4" round	700	3000K	ELV/TRIAC	50W PAR20
FDL4S07930TE1W	4" square				50W PAR20
FDL6R09930TE1W	6" round	900			65W PAR30
FDL6S09930TE1W	6" square				65W PAR30
Accessories					
FDLRN	Round new construction plate				
FDLSN	Square new construction plate				
FDL06C	6ft extension cable				
FDL20C	20ft extension cable				

The Philips LED Flat downlight measures only 1/2" in depth, allowing for easy installation without concern for ceiling plenum space.



Why choose the Philips LED Flat downlight?

- Quick and easy installation without frame or reflector.
- 1" depth, low profile for non-intrusive install.
- Dimmable to 10%.
- Lifetime >50,000 hours (L70).
- IC-rated for direct contact with insulation.
- UL1598 wet location rated.



Components

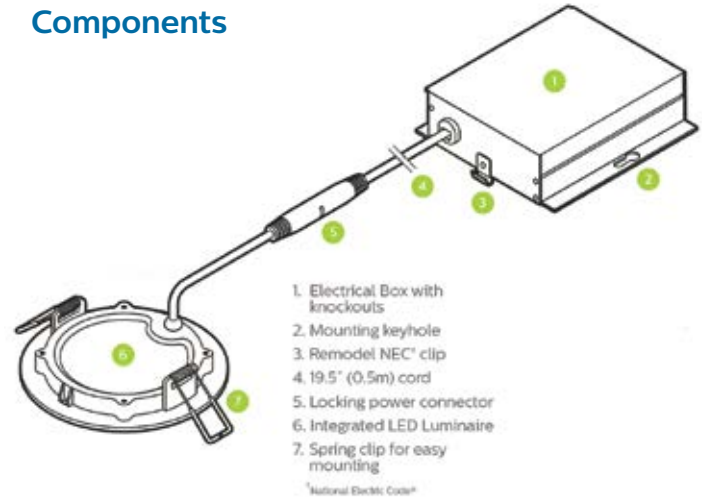

Dimensions

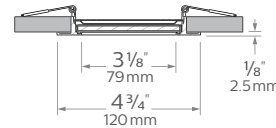

Flat Downlight 4"

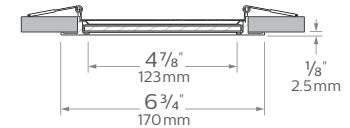

Flat Downlight 6"

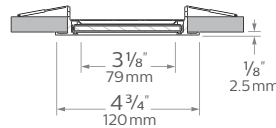

Flat Downlight 4"

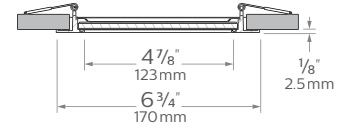

Flat Downlight 6"

PHILIPS

Downlighting

Mini gimbal
Mini downlight



Accent with accuracy, install with ease

Philips Catalog Code	Size/Shape	Lumens	Color Temp	Voltage	Replaces
PMD3R069301FW	3" round	550	3000K	120V	50W MR16
PMG3R06930NF1W					50W MR16
Accessories					
PMDRN	Round new construction plate				
PMD06C	6ft extension cable				
PMD20C	20ft extension cable				

The Philips LED Mini downlight & Mini gimbal let you emphasize without the size. Easy-install fixtures with a detachable junction box.



Why choose Mini downlight & Mini gimbal?

- Quick and easy installation without frame or reflector.
- 1" depth, low profile for non-intrusive install.
- Dimmable to 10%.
- Lifetime >50,000 hours (L70).
- IC-rated for direct contact with insulation.
- 5 year limited warranty.

Dimensions

Mini Downlight

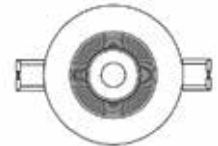
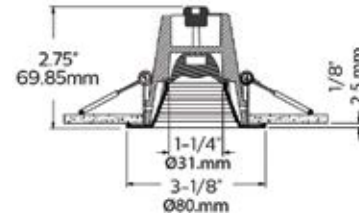

Mini Gimbal

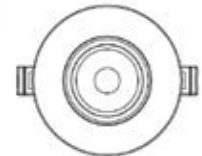
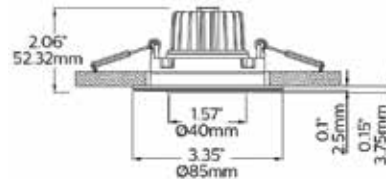

PHILIPS

Downlighting

Surface mount



The shallow ceiling problem solver

Philips Catalog Code	Size	Lumens	Color Temp	Dimming	Replaces
PSD5R079301W	5"	600	3000K	ELV/TRIAC	65W PAR30
PSD7R099301W	7"	1000			75W PAR38

The **Philips LED Surface mount** is ideal when you are faced with a challenging ceiling, but you still want a good-looking downlight.



Insulation Contact

Why choose the Philips LED Surface mount?

- Easy to install on standard junction boxes.
- Surface mount downlight solves the problem of limited plenum space.
- Glare controlling lens for comfortable light distribution.
- Affordable alternative to Air-Seal IC recessed housings.
- Support wire attached for easy installation.
- Energy Star and Title 24 listed.



Dimensions

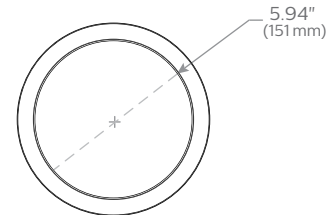
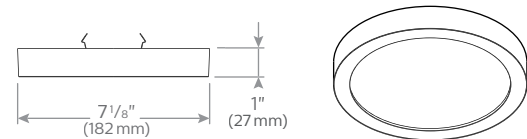
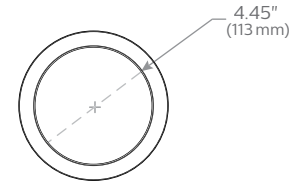
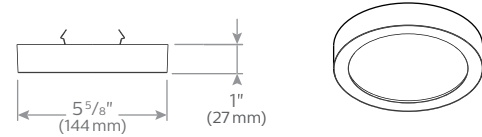

PHILIPS

Downlighting

Retrofit downlight



An LED retrofit as **easy as snap & click**

Philips Catalog Code	Size	Lumens	Color Temp	Dimming	Replaces
PRD4R089301W	4"	900	3000K	ELV/TRIAC	50W PAR20
PRD5R129301W	5/6"	1400			65W PAR30

Philips LED Retrofit downlight is so hassle-free to install, it will save you plenty of time and frustration on the job site. You may not even need to open your toolbox.



Why choose the Philips LED Retrofit downlight?

- Utilizes existing frames to make replacing old downlighting and upgrading to LED, a truly easy task.
- Flexible springs allow for installation without tools.
- Quick-connect plug and medium-based socket adapter means no extra accessories to purchase.
- Contemporary and discreet, white baffle trim design.
- Uniform LED light with glare-reduction filter, means a more comfortable space.



Dimensions

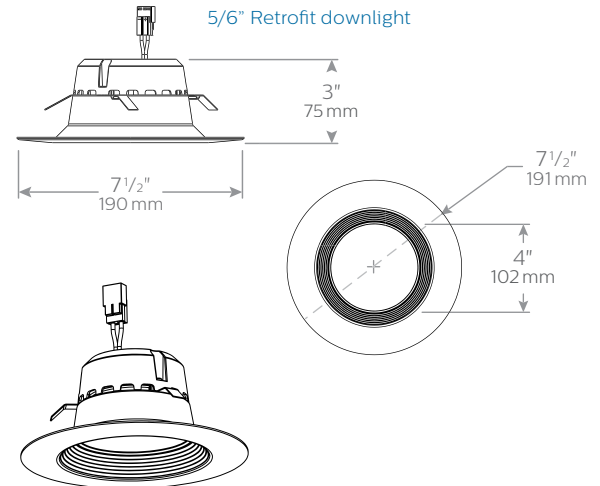
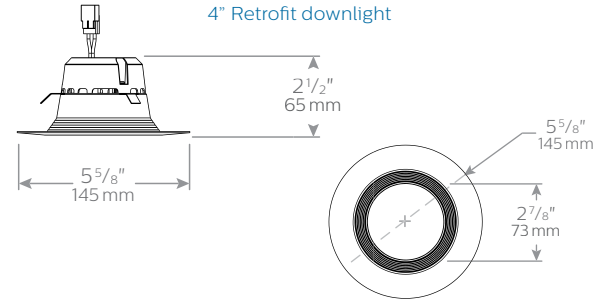

PHILIPS

Industrial

High bay



Compact & economical with the latest technology

Philips Catalog Code	Size	Lumens	Color Temp	Dimming	Replaces
PFBX16LL40-UNV	2' x 2'	16,000	4000K	0-10V	6xF32T8 or 400W HID
PFBX16LL50-UNV			5000K		
PFBX24LL40-UNV	2' x 2'	24,000	4000K	0-10V	8xF32T8 or 400W HID
PFBX24LL50-UNV			5000K		
PFBX CHAIN KIT, PFBX-GRIP10, PFBX-GRIP5, PFBX-PENHGR	High bay mounting accessories (54" chains, 10' cable, 5' cable, pendant hanger)				

Philips LED High bay industrial luminaires save energy without straining your project budget or sacrificing light output.



Why choose the Philips LED High bay?

- Versatile fixture ideal for a variety of spaces including warehouses, big box retail and school gymnasiums.
- 16,000 & 24,000 lumen versions available.
- Both versions are serious energy savers with efficacy up to 138 lumens per watt.
- Simple installation.
- Dimming is standard.
- DLC listed.

Mounting options

CABLE MOUNT
& V brackets
(5' or 10' cables)

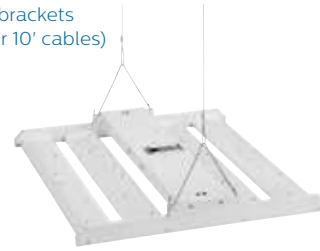

PENDANT hanger
(adds 3" to height)

CHAIN KIT
54" chains
& V brackets



Accessories

WIRE GUARD

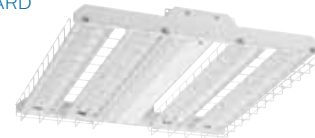

PHILIPS

Linear

Strip, wraparound
& industrial



Real convenience for your operation's success

Philips Catalog Code	Size	Lumens	Color Temp	Dimming	Replaces
PFSSEZ440L830-UNV (Strip)	4'	4000	3000K	N/A	2xF32T8
PFSSEZ440L840-UNV (Strip)			4000K		2xF32T8
PFSWEZ440L830-UNV (Wraparound)	4'	4000	3000K	N/A	2xF32T8
PFSWEZ440L840-UNV (Wraparound)			4000K		2xF32T8
PFSI455L840-UNV-DIM (Industrial)	4'	5500	4000	0-10V	3xF32T8
PFSI8110L840-UNV-DIM (Industrial)	8'	11000	4000	0-10V	6xF32T8

Tough and dependable, the **Philips LED Linear** family includes strip, industrial and wraparound luminaires for ease of handling and flexibility.



Why choose these Philips Linear luminaires?

- Tough and dependable, the Philips LED Linear family includes strip, industrial and wraparound luminaires.
- Efficacy up to 131 lumens per watt.
- Simple installation.
- Before, during and after installation, you can trust them to help you quickly complete projects without hassles or troubleshooting, while delivering consistent comfort and long-term energy savings.

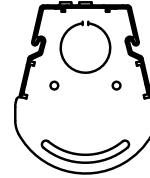

PFSSEZ: Linear strip

- Efficacy: 114 lm/W
- 4ft lengths
- Lumen output: 4000lm*
- Color temperatures: 3000K or 4000K

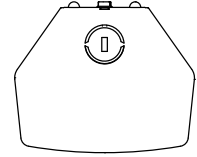

PFSWEZ: Linear wraparound

- Efficacy: 109 lm/W
- 4ft length
- Lumen output: 4000lm*
- Color temperatures: 3000K or 4000K

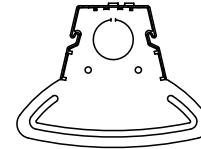

PFSI: Linear industrial

- Efficacy: 131 lm/W
- 4ft & 8ft lengths
- Lumen outputs: 5500 or 11,000lm*
- Color temperature: 4000K
- 0-10V 1% dimming

*Nominal delivered lumen output at 25°C ambient.

PHILIPS

Linear

Wet Linear Strip



**Rugged
reliability**
for efficient
environments

Philips Catalog Code	Size	Lumens	Color Temp	Dimming	Replaces
PV3WEZ440L840-UNV	4'	4000	4000K	N/A	2xF32T8

Philips LED Wet Linear Strip will work hard and long to give you the durability you are looking for in challenging locations.



Why choose the Philips Wet Linear Strip?

- A superb choice for tough environments both indoor and out.
- The molded fiberglass and reinforced polyester body mean no rusting, oxidation or corrosion.
- LED light engines and drivers are field replaceable.
- cETLus listed to meet UL for -20C to 40C ambient. Suitable for wet locations.
- Components are RoHS compliant.
- 5 Year limited warranty.

Dimensions

Length: 51-9/16" (1310mm)



4-1/4"
(108mm)

4-1/2"
(114mm)

Mounting Bracket

(Set of two included)



PHILIPS

Recessed

Flat panel

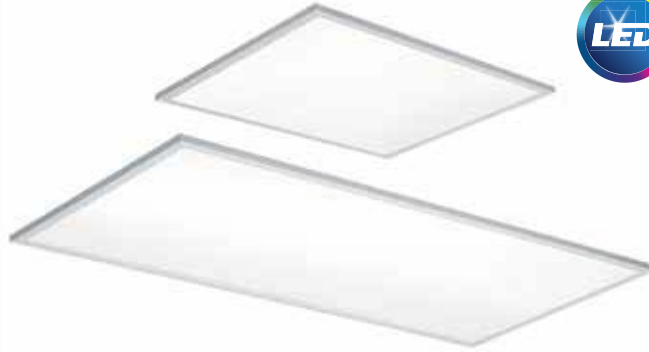

A good deal more than quality & long life

Philips Catalog Code	Size	Lumens	Color Temp	Dimming	Replaces
P2FXP38B835-2-DS-UNV-DIM	2x2'	3800	3500K	0-10V	2xF17T8
P2FXP38B840-2-DS-UNV-DIM			4000K		2xF17T8
P2FXP42B835-4-DS-UNV-DIM	2x4'	4200	3500K	0-10V	2xF32T8
P2FXP42B840-4-DS-UNV-DIM			4000K		2xF32T8

Philips Flat panel LED sets the stage for quality, affordability and longevity. Each low profile, dimmable luminaire will give you the peace of mind and reliability of lasting performance.



Why choose the Philips Flat panel LED?

- Help bolster wellbeing and productivity without worrying about flicker and other undesired effects.
- Immerse users in comfortable, welcoming spaces that are free of glare and distractions; with color that remains consistent across luminaires and over time.
- Protect both the integrity of electrical equipment and overall building efficiency from the effects of total harmonic distortion.
- Well-suited for office, healthcare and educational facilities.

Dimensions

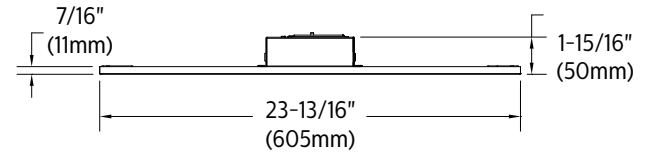

Philips drivers provide reliable performance for peace of mind.



PHILIPS

Recessed

Recessed troffer



Clear cut
progress,
**lasting &
consistent**

Philips Catalog Code	Size	Lumens	Color Temp	Dimming	Replaces
P2FGG38B835-2-D-UNV-DIM	2' x 2'	3800	3500K	0-10V	2xF17T8
P2FGG38B840-2-D-UNV-DIM			4000K		2xF17T8
P2FGG42B835-4-D-UNV-DIM	2' x 4'	4200	3500K	0-10V	2xF32T8
P2FGG42B840-4-D-UNV-DIM			4000K		2xF32T8

The **Philips LED Recessed troffer** is the ideal solution for functional, efficient, and environmentally friendly illumination throughout the space.



Why choose the Philips LED Recessed troffer?

- Discretely designed to blend seamlessly into your space.
- Access to LED boards and drivers from below the ceiling increases maintenance convenience.
- Diffused ribbed lens creates soft, even illumination.
- Choose from 3500 or 4000K color temperatures.

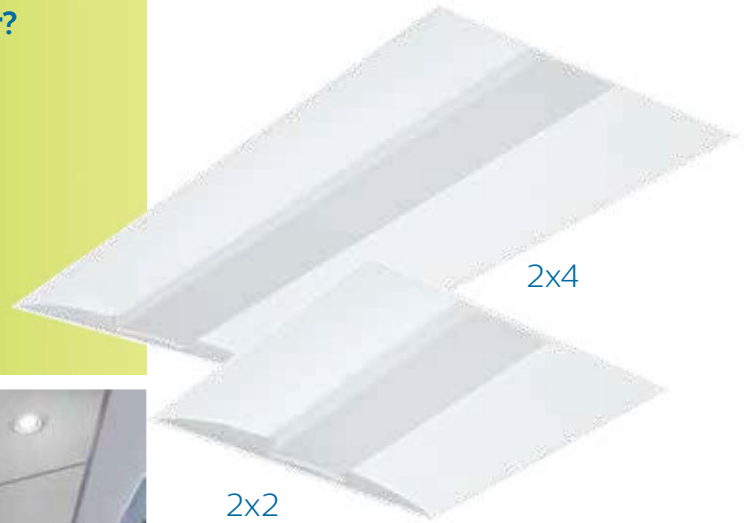

Dimensions

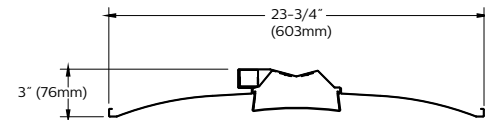

PHILIPS

Exit & Emergency

Emergency unit
Exit combo
Exit sign



Flexibility, value & peace of mind

Philips Catalog Code	Letter Color	Finish	Operation	
PVERWEM (Exit Sign)	Red	White	Emergency (Nicad Battery)	
PVEGWEM (Exit Sign)	Green	White	Emergency (Nicad Battery)	
Philips Catalog Code	Voltage	Finish	# LED Lamps	Remote
PVLLCR2R (Red Letter Exit Combo)	3.6V	White	2 - 1W	2-1W or 1-2W Head
PVLLCG2R (Green Letter Exit Combo)	3.6V	White	2 - 1W	2-1W or 1-2W Head
PVLLU (Emergency Unit)	3.6V	White	2 - 1W	None
PVLL1R (Remote Lamp Head)	3.6V	White	1 - 1W	Indoor
PVLL2R (Remote Lamp Head)	3.6V	White	2 - 1W	Indoor
PVLL1RGO (Remote Lamp Head)	3.6, 6, 9.6 or 12V	Gray	1 - 1W	Outdoor
PVLL2RGO (Remote Lamp Head)	3.6, 6, 9.6 or 12V	Gray	2 - 1W	Outdoor

The Philips LED Exit and Emergency

Light to go products feature low profile designs and great value.



Why choose Philips Exit & Emergency products?

- A complete family of dependable products to make buying, ordering & installation for large projects easier.
- Exit signs run off a long-life, 6 volt maintenance-free battery.
- All 3 versions can mount on wall or ceiling.
- Emergency unit and Exit combo can be used for indoor or covered outdoor spaces.
- Units and combos also contain a manual test switch with LED light indicator and supply emergency illumination for at least 90 minutes.



Dimensions

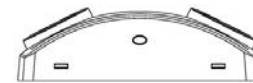
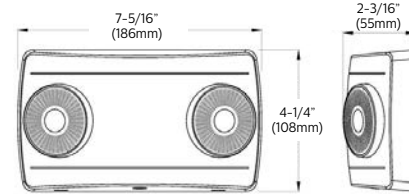

PVLLU

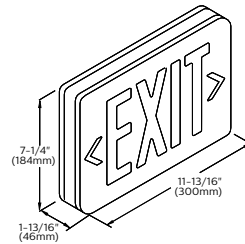

PVE

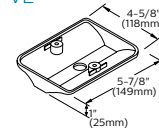

Canopy



PVLLC

PHILIPS

Site & Area

Area light



Enhancing
a sense
of security
for the
long haul

Philips Catalog Code	Wattage	Color Temp	Distribution	Lumens	Replaces HID
PAL-150-NW-G1-AR-3-8-BZ	150W	4000K	Type 3	18,585	250W PSMH
PAL-150-NW-G1-AR-4-8-BZ	150W	4000K	Type 4	18,324	250W PSMH
PAL-200-NW-G1-AR-3-8-BZ	200W	4000K	Type 3	24,382	400W PSMH
PAL-200-NW-G1-AR-4-8-BZ	200W	4000K	Type 4	24,109	400W PSMH
PAL-200-NW-G1-AR-3-8-IMRI-BZ	200W	4000K	Type 3	24,382	400W PSMH
PAL-200-NW-G1-AR-4-8-IMRI-BZ	200W	4000K	Type 4	24,109	400W PSMH

The **Philips LED Area light** features energy-saving technology ideal for pole mounted lighting applications. Ideal for parking lots, security lighting, and general purpose area lighting.



Why choose the Philips LED Area light?

- Budget-friendly, high quality area lighting for parking and outdoor spaces.
- LED technology will save up to 68% energy over HID.*
- Mounts standard to round or square pole.
- Durable aluminum construction.
- Lifetime >54,000 hours.**
- 5 year limited warranty.



Dimensions

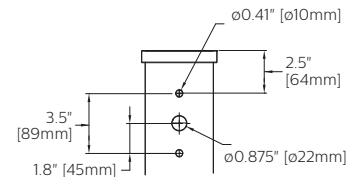
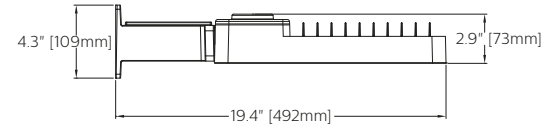
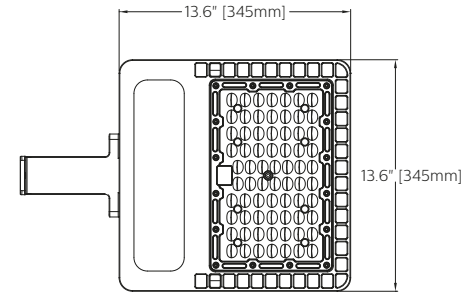

POLE DRILL TEMPLATE

*Based on comparison between 250W PSMH (at 295W) and AL-150-NW-G1 at 147W.

**Predicted performance derived from LED manufacturer's data and engineering design estimates, based on IESNA LM-80 methodology.

PHILIPS

Floodlights

General purpose floods



Versatile & stylish

for a wide
range of
applications

Philips Catalog Code	Wattage	Color Temp	Lumens	Mounting	Replaces HID
PFL20-NW-G1-K-FL-8-BZ	20W	4000K	2122	Knuckle Mount ½" NPS male	70W PSMH
PFL40-NW-G1-K-FL-8-BZ	39W	4000K	4433	Knuckle Mount ½" NPS male	150W PSMH
PFL80-NW-G1-T-FL-8-BZ	79W	4000K	8856	Trunnion	250W PSMH
PFL150-NW-G1-T-FL-8-BZ	146W	4000K	16,325	Trunnion	400W PSMH
PFL300-NW-G1-T-FL-8-BZ	301W	4000K	34,025	Trunnion	750W PSMH

The Philips LED General purpose floodlights offer energy saving LED technology for long life and reduced maintenance. Energy savings don't get better than this.



Why choose the Philips LED General purpose floodlight?

- Complete family of LED floodlights ideal for illuminating signs, building facades or other dark areas.
- Can be mounted on the ground, wall, or pole-mounted.
- All sizes arrive fully assembled and ready to install.
- Fade-resistant, textured bronze finish with tempered glass lens that is heat and impact resistant.
- IP66 rated, 5 year limited warranty.



Dimensions

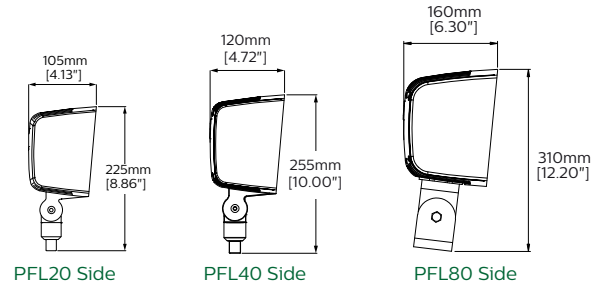
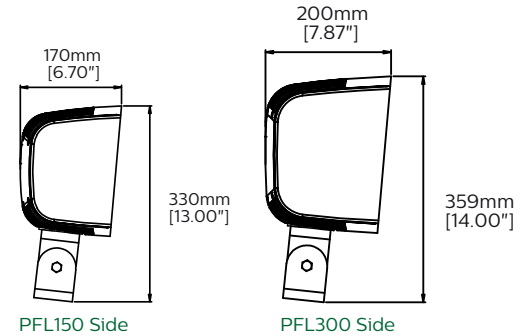

PHILIPS

Site & Area

Dusk to Dawn



**Brighten
spaces
evenly,
without
glare**

Philips Catalog Code	Wattage	Color Temp	Voltage	Lumens	Replaces
PDTD40NWG3AR5TLRPC1GY3S	40W	4000K	120V	4973	100W MH

Accessories (order separately) · PDTDARMGY3S – Mounting arm with hardware

The **Philips Dusk to Dawn** is only on when you need it. A great performing LED light for general purpose areas that fits your budget.



Why choose the Philips LED Dusk to Dawn?

- Excellent choice for general areas, where lighting can enhance security.
- Provides up to 70% energy savings over HID.*
- Refracted lens design spreads light evenly and significantly reduces glare.
- Direct mount or arm mount.
- Sturdy, fade and abrasion resistant, built of a one-piece die-cast aluminum housing.



Dimensions

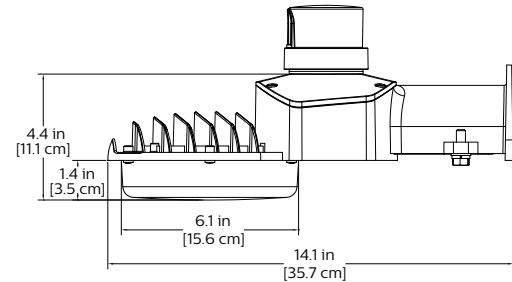

Approximate luminaire weight (less arm) – 3.7lbs (1.7kg)

PDTDARMGY3S – Arm accessory (order separately)

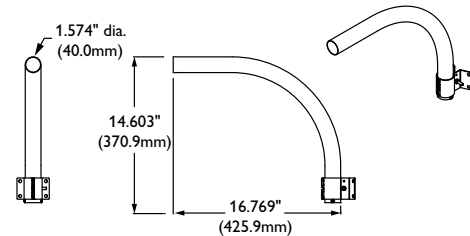

*DTDLED rated 39 input watts is 70% less versus metal halide systems rated 129 input watts.

PHILIPS

Garage
& Canopy



Compact & efficient, built to last

Philips Catalog Code	Wattage	Color Temp	Distribution	Lumens	Replaces HID
PGC40-NW-G1-SM-5-8-BZ	37W	4000K	Type 5	4735	70W PSMH
PGC57-NW-G1-SM-5-8-BZ	57W	4000K	Type 5	6322	100W PSMH

The **Philips LED Garage and Canopy** light is slim and durable with a light-weight design, and provides you with a visually appealing lighting experience.



Why choose the Philips LED Garage & Canopy?

- Cost-effective and efficient lighting for parking garages, covered walkways and canopies.
- Slim and compact design.
- Durable, weather-tight IP65 rated construction with a rugged, UV stabilized, frosted lens.
- Easy to install with the integral quick-mount plate, or pendant mount with 3/4" rigid conduit.
- 5 year limited warranty.



Dimensions

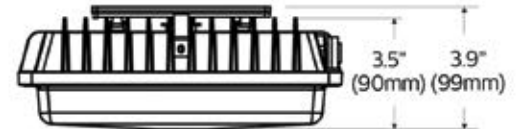
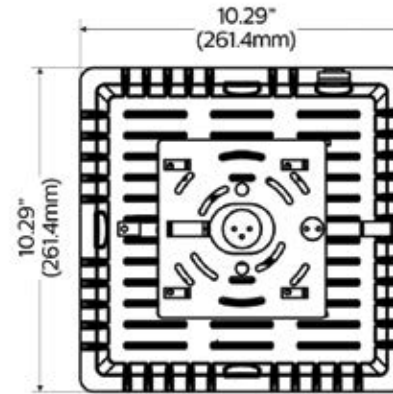

PHILIPS

Special Purpose

Vaportight



Small but mighty

Philips Catalog Code	Wattage	Color Temp	Lumens	Mounting	Replaces
PVCXL-14-NW-G1-8	14W	4000	1390	Ceiling	100W INC
PVWXL-14-NW-G1-8				Wall	

End your search for durable lighting that will really last, choose the Philips Vaportight LED. The mighty little light with long lasting shine.



Why choose the Philips LED Vaportight?

- Wall or ceiling mounting available.
- Provides 83% energy savings over 100W Incandescent.*
- Heat and shock resistant glass globe with cast aluminum guard.
- Long life reduces maintenance.
- Provides up to 1,390 lumens.
- 5 year limited warranty.

*Based on comparison between 100W INC @1710 lumens and PVCXL14-NW-G1 @ 1390 lumens



Dimensions

Ceiling Mount (PVCXL)

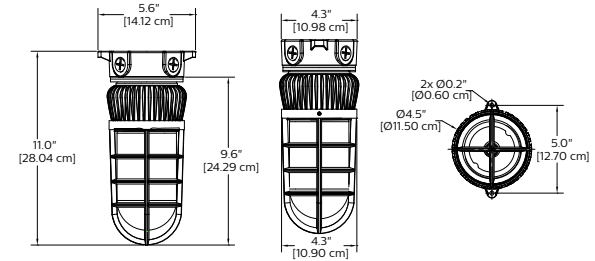

Wall Mount (PVWXL)

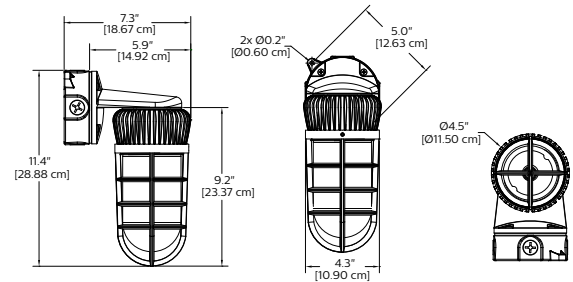

PHILIPS

Wall Mount

Low profile wall



Sleek & slim, with energy saving illumination

Philips Catalog Code	Wattage	Color Temp	Voltage	Lumens	Replaces HID
PPW-15-NW-G1-8-BZ	15W	4000K	120-277V	1656	50W PSMH
PPW-30-NW-G1-8-BZ	30W			3090	70W PSMH
PPW-50-NW-G1-8-BZ	50W			5114	100W PSMH

The **Philips LED Low profile wall** provides efficacies up to 110 lumens per watt, with significant energy savings over HID luminaires.



Why choose the Philips LED Low profile wall?

- Budget-friendly, discreet fixture for a wide variety of outdoor spaces.
- Energy efficient fixture that delivers up to 110 lumens per watt.
- 3 size options: 15, 30 or 50 watt.
- Slim profile, just over 4 inches.
- Durable construction of die-cast aluminum with a UV stabilized lens and stainless steel hardware.
- 5 year limited warranty.



Dimensions

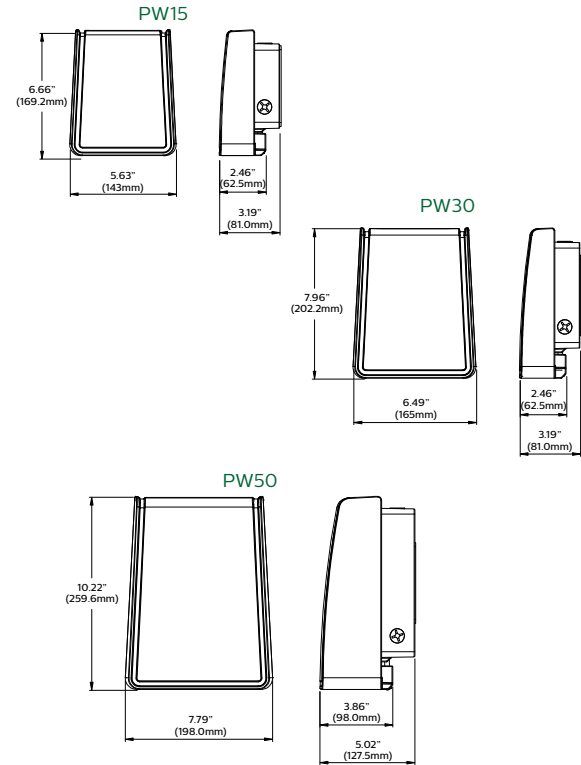

PHILIPS

Wall Mount

Tall wall pack



Tall,
brilliant
& **full**
of life...

Philips Catalog Code	Wattage	Color Temp	Voltage	Lumens	Replaces HID
PTW-20-NW-G1-8-BZ	20W	4000K	120-277V	1674	50-70W MH

The **Philips LED Tall wall pack** is an easy choice for almost any outdoor lighting location with durable illumination that was built to last.



Why choose the Philips LED Tall wall pack?

- Lightweight, compact and built to last.
- Provides up to 83% energy savings over 70W Metal Halide luminaires.*
- The bronze housing is die cast aluminum and impact resistant polycarbonate, with a frosted lens.
- Installation is quick and easy, by mounting to a standard 3 1/2 or 4" junction box.
- Rated for temperatures from -40 to 104°.



Dimensions

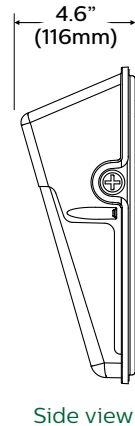
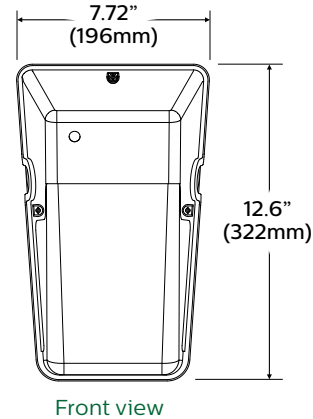

*Based on comparison between TW20 @ 20W and 70W Metal halide.

PHILIPS

Wall Mount

Wall pack



Proven design meets LED technology

Philips Catalog Code	Wattage	Color Temp	Voltage	Lumens	Replaces HID
PWP-30-NW-G1-8-BZ	30W	4000K	120-277V	3355	70W PSMH
PWP-50-NW-G1-8-BZ	50W			5541	100W PSMH
PWP-75-NW-G1-8-BZ	75W			8999	150-250W PSMH

With efficacies up to 118 LPW, **Philips new LED Wall packs** help you to upgrade from costly HID fixtures with confidence. Move into the future with time-proven design from a name you can trust.



Why choose the Philips LED Wall pack?

- An easy switch from costly HID fixtures.
- Flexible options – choose from 30, 50 and 75 watts in two different sizes.
- The 50 watt Wall Pack provides the equivalent illumination to 100W HID, and uses over 50% less energy.*
- Glass refractor lens design cuts down on glare.
- One-piece die-cast aluminum housing.
- 5 year limited warranty.



Dimensions

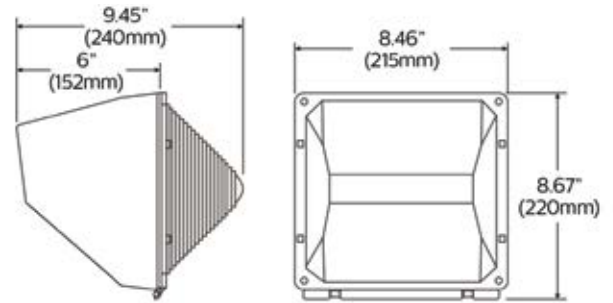

PWP30

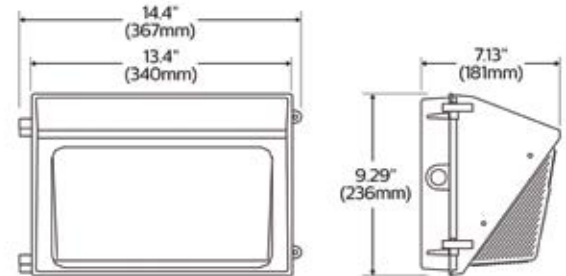

PWP50 and PWP75

*Based on comparison between 100W HPS Wall pack at 115W providing 6100 lumens and 50W WP LED providing 5500 lumens



© 2018 Philips Lighting Holding B.V. All rights reserved. Philips reserves the right to make changes in specifications and/or to discontinue any product at any time without notice or obligation and will not be liable for any consequences resulting from the use of this publication.

PLT-17103PG-BR 01/18 philips.com/Lighttogo

Philips Lighting
North America Corporation
200 Franklin Square Drive
Somerset, NJ 08873
Tel. 855-486-2216

Philips Lighting Canada Ltd.
281 Hillmount Rd,
Markham, ON,
Canada L6C 2S3
Tel. 800-668-9008