

PHILIPS

Adapter Ring D

H7-LED

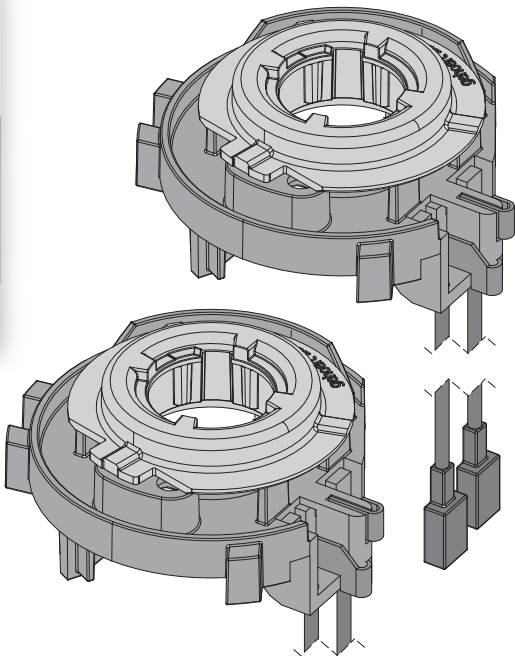

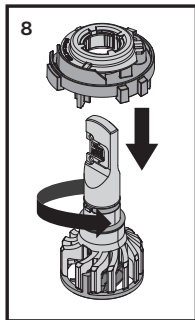
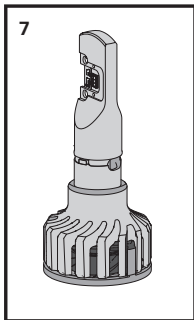
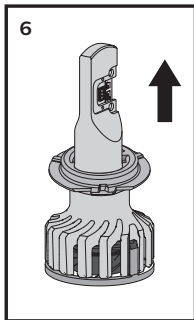
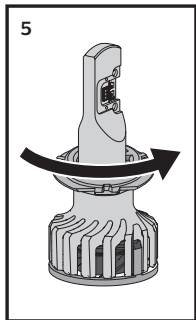
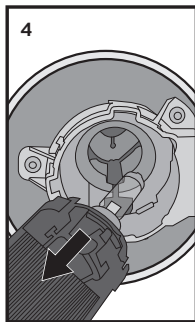
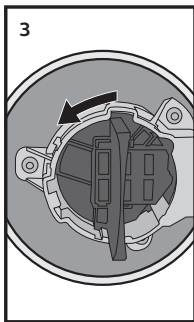
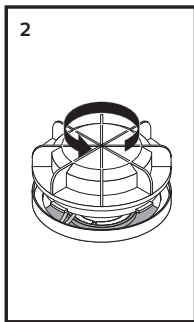
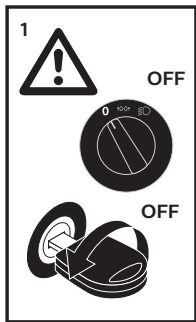

9

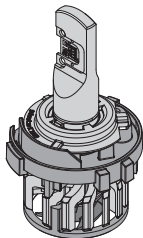

10

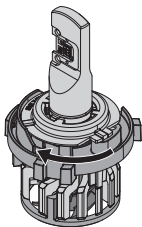

11

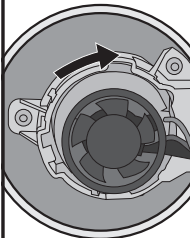

12

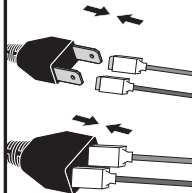

13



14



15

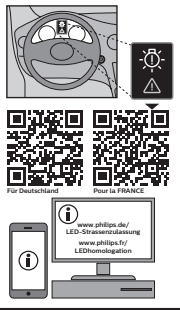
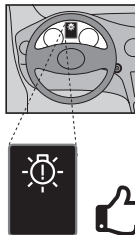



**Lumileds est le garant de ce produit.
2022 © Lumileds Holding B.V. Tous droits réservés. La marque commerciale Philips et l'emblème du bouclier Philips sont la propriété de Koninklijke Philips N.V. et sont utilisés sous licence.**

**Lumileds ist der Garantiegeber für dieses Produkt.
Philips und das Philips Wappen sind eingetragene Marken von Koninklijke Philips N.V. und werden unter Lizenz verwendet.
©2022 Lumileds Holding B.V. Alle Rechte vorbehalten.**

**Lumileds is the warrantor of this product.
Philips and the Philips Shield Emblem are registered trademarks of Koninklijke Philips N.V. and are used under license.
© 2022 Lumileds Holding B.V. All rights reserved.**

