

# PHILIPS

Adapter Ring D

H7-LED

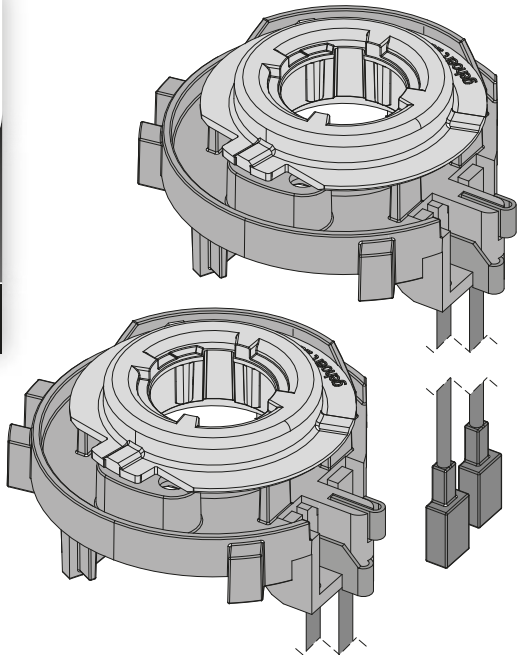

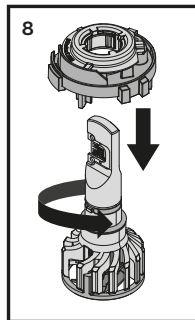
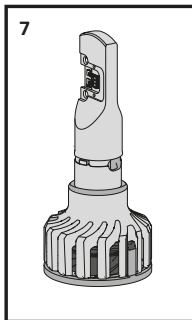
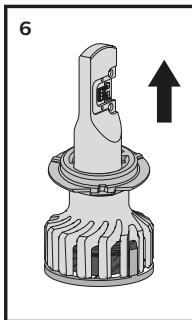
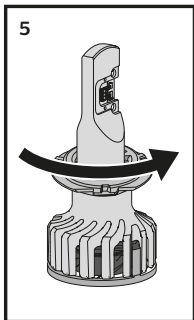
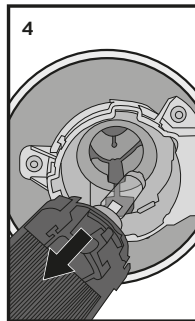
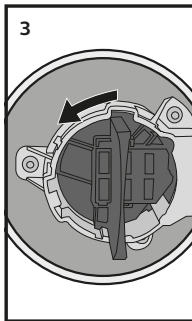
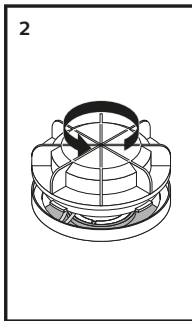
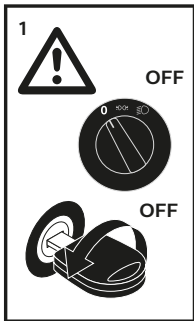

9

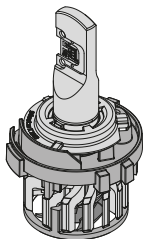

10

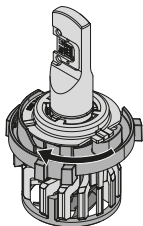

11

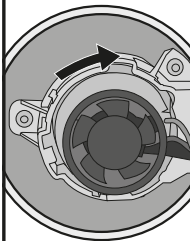

12

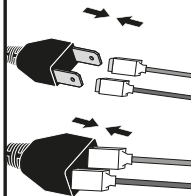

13



14

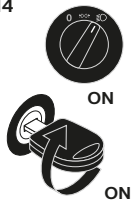

15

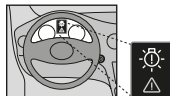
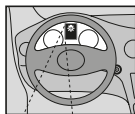



**Lumileds ist der Garantiegeber für dieses Produkt.  
Philips und das Philips Wappen sind eingetragene Marken von  
Koninklijke Philips N.V. und werden unter Lizenz verwendet.  
©2021 Lumileds Holding B.V. Alle Rechte vorbehalten.**

Lumileds is the warrantor of this product.  
Philips and the Philips Shield Emblem are registered trademarks of  
Koninklijke Philips N.V. and are used under license.  
© 2021 Lumileds Holding B.V. All rights reserved.

