

Installation Guide

Stack Mount for Philips MP90 CPU and G5

The purpose of this guide is to:

1. Describe attachment of table top mount to Stack Mount (page 1).
2. Describe attachment of Stack Mount to MP90 CPU (pages 2 – 3).

Parts Reference

The following parts and hardware are included in this installation kit (hardware not shown):

Item #	Description	Qty
1	Stack Mount Assembly	1
2	M6 x 10 mm Flat Head Machine Screw (FHMS)	3
3	M3 x 12mm Pan Head Machine Screw (PHMS)	5
4	Spacer, Camlock Lever	1
5	#4 x 3/8" Flat Head Sheet Metal Screw (FHSMS)	1

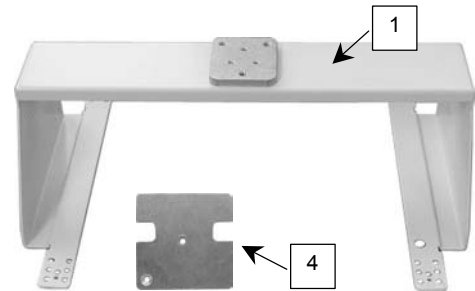

Tools Required: Small and medium-tipped Phillips screwdrivers (not provided).

Attaching Philips Table Top Mount to Stack Mount

This procedure requires attachment of a Philips-supplied table top mount. The table top mount is not included in this installation kit.

1. Fasten table top mount to Mounting Adapter with three M6 x 10 mm FHMS as shown below.

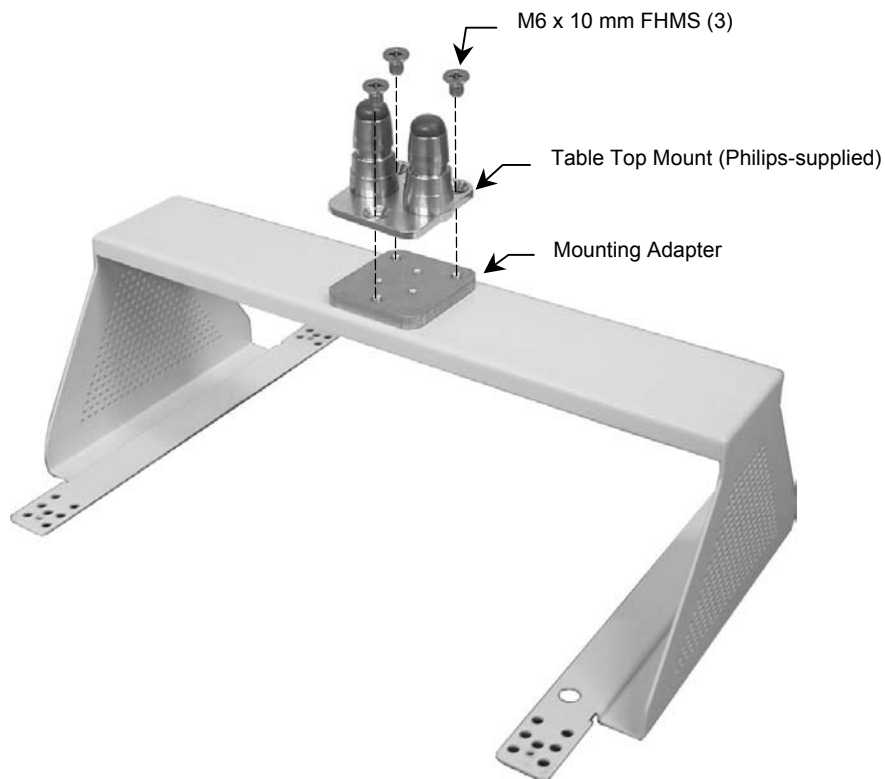

Attaching Stack Mount to CPU

1. Unscrew the four (4) feet and camlock lever and remove them from the bottom of the CPU (below left). Remove existing screws from feet and camlock lever. New screws (M3 x 12mm) are provided for reinstalling feet and camlock lever.

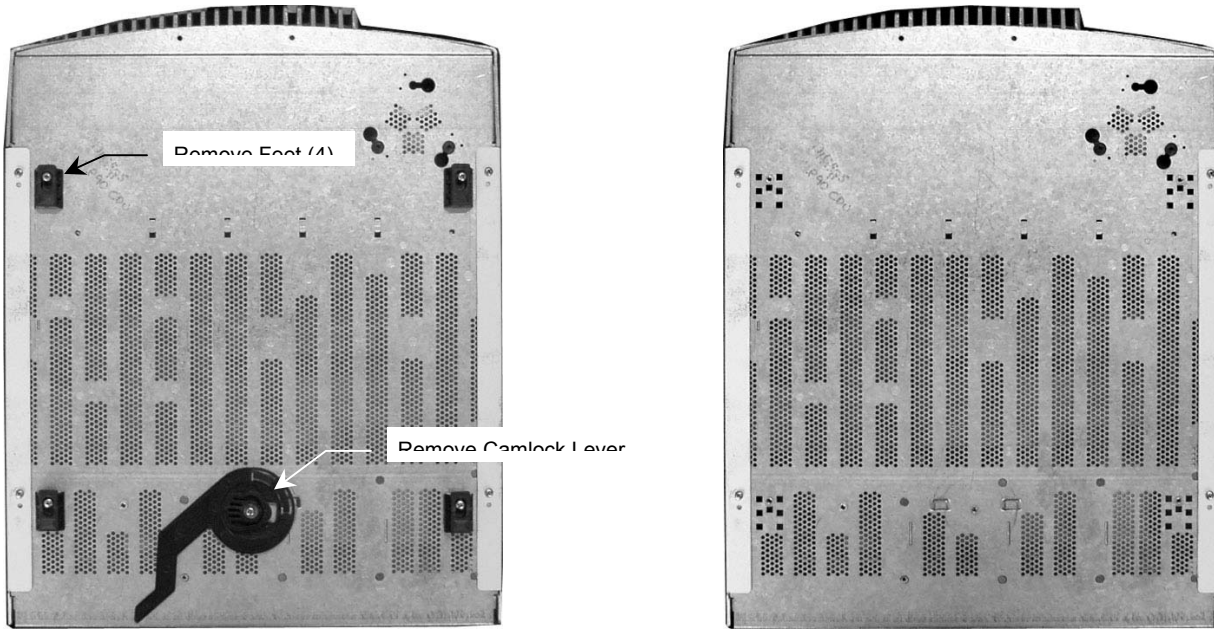

2. Ensure foot-mounting pattern on Mount is oriented same as foot-mounting pattern on bottom of CPU. Slide Mount over the CPU. Align four (4) mounting patterns on bottom of Mount with corresponding mounting patterns on bottom of CPU (below right).

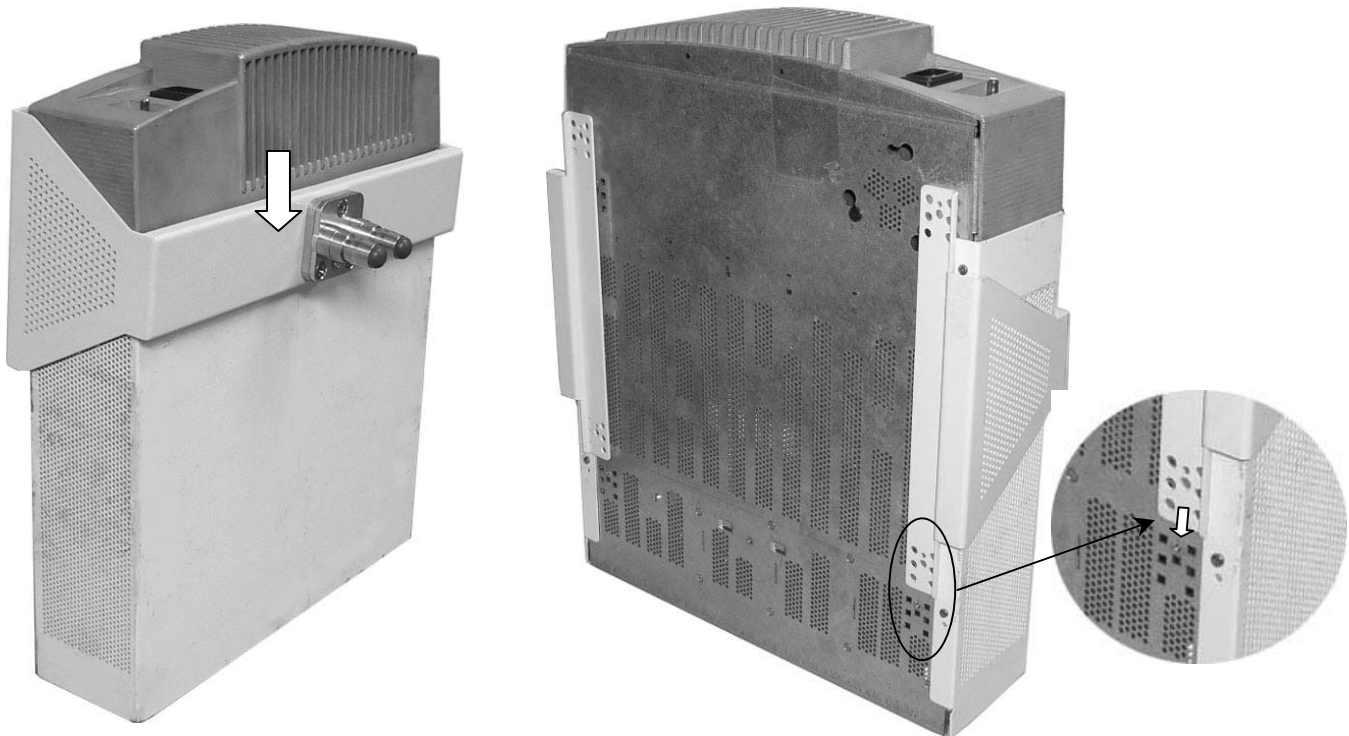

3. Reinstall four (4) feet (through Mount) with four (4) M3 x 12mm PHMS provided (upper photo).
4. Refer to lower photos below: Align center hole in Camlock Lever Spacer with Camlock Lever mounting hole. Ensure two (2) slots in Spacer are aligned with corresponding indentations in housing and fasten Spacer to corresponding vent hole with one (1) #4 x 3/8" FHSMS. Fasten Camlock Lever to Spacer with one (1) M3 x 12mm PHMS.

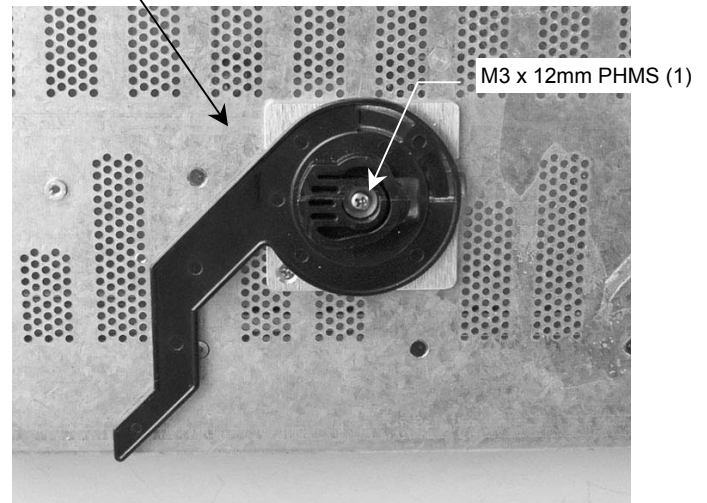
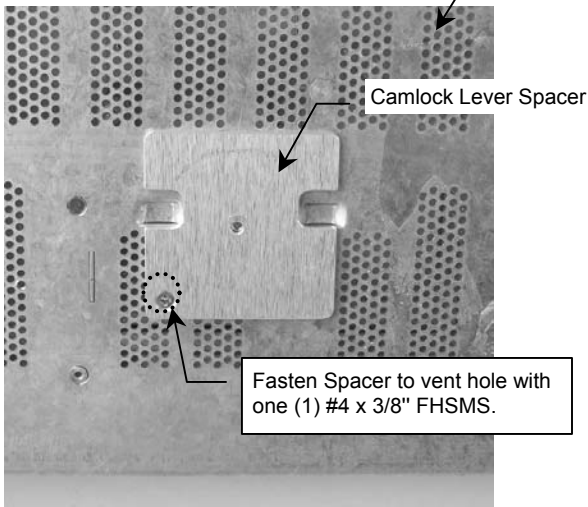
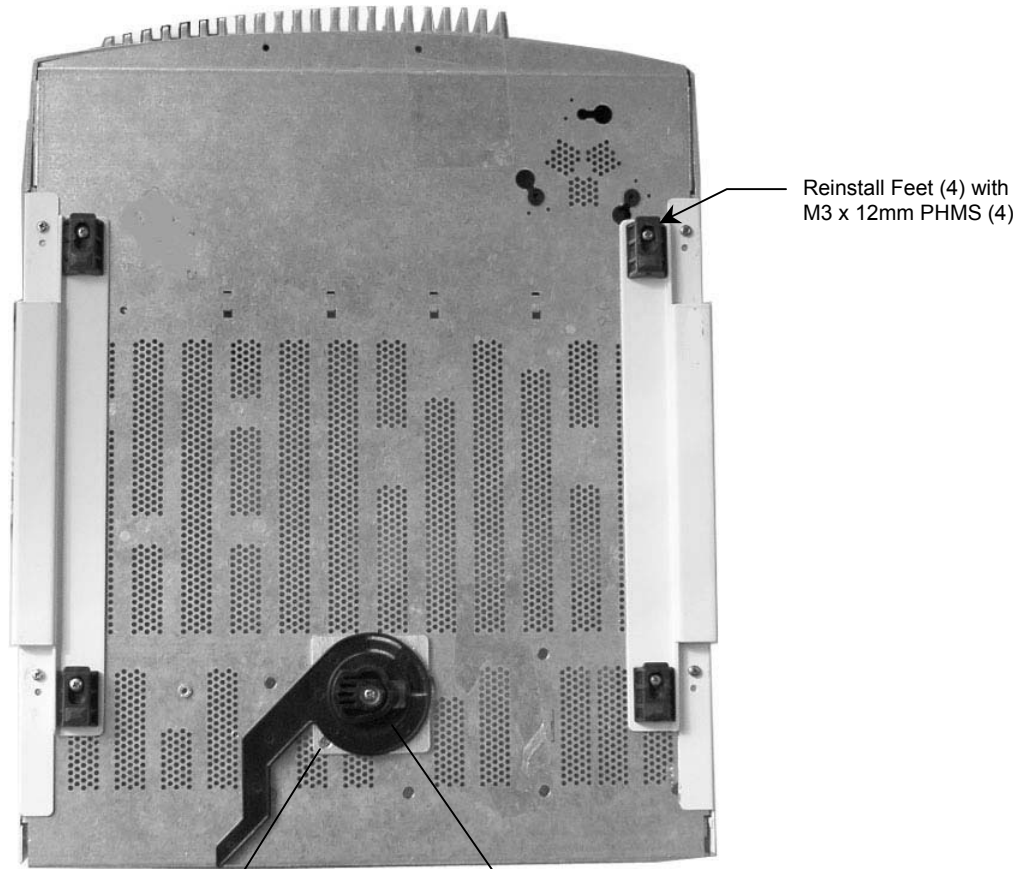

5. Mount CPU in camlock rails according to Philips installation instructions.

Mounting G5 on Stack Mount

1. Mount G5 on table top mount in accordance with Philips installation instructions. Installation shown below.

