

POLYMOUNT® WALL CHANNEL INSTALLATION INSTRUCTIONS

FOR 5/8" GYPSUM BOARD WALLS TO COMPLY WITH CALIFORNIA SEISMIC REQUIREMENTS FOR WALL MOUNTED INSTRUMENTATION. CALIFORNIA OSHPD ANCHORAGE PRE-APPROVAL NUMBER R0079

ANCHORAGE OR SUPPORT OF METAL STUD WALL MUST BE VERIFIED BY THE PROJECT ENGINEER AND APPROVED BY OSHPD PRIOR TO THE INSTALLATION OF ANY MOUNTING SYSTEM.

THE MAXIMUM LOAD RATING FOR THIS SYSTEM IS 80 LBS/36Kg (VB SERIES PRODUCTS) OR 110 LBS/50Kg (FT SERIES PRODUCTS)

WALL CHANNEL ILLUSTRATION

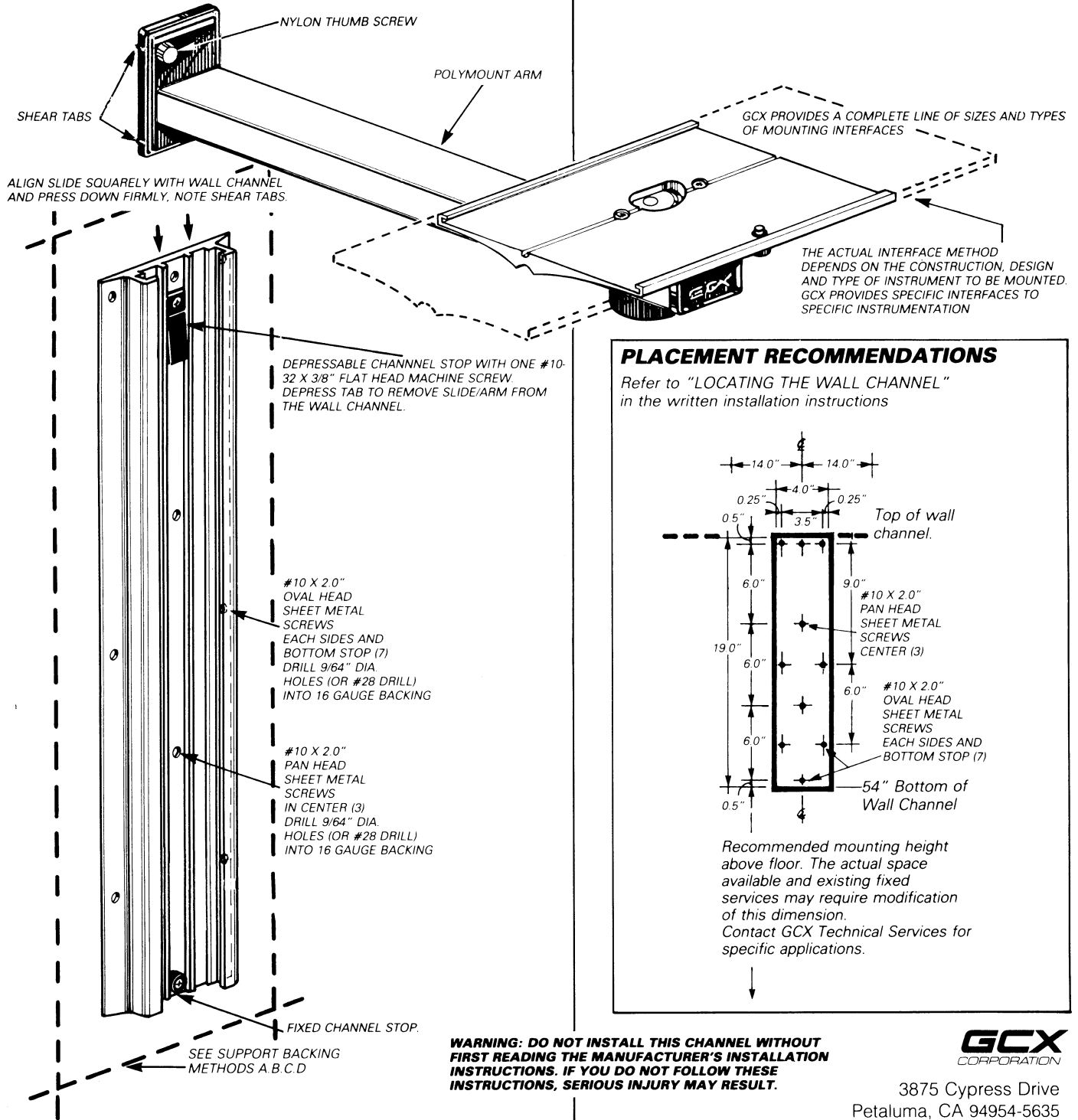

PLACEMENT RECOMMENDATIONS

Refer to "LOCATING THE WALL CHANNEL" in the written installation instructions

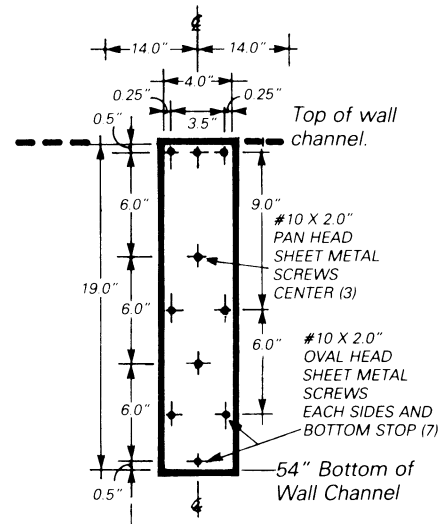

Recommended mounting height above floor. The actual space available and existing fixed services may require modification of this dimension. Contact GCX Technical Services for specific applications.

POLYMOUNT®

POLYMOUNT® BIOMEDICAL INSTRUMENT MOUNTING SYSTEMS FOR EQUIPMENT WEIGHING NOT MORE THAN 80 POUNDS (36 KG)

PLEASE REVIEW THE INSTRUCTIONS AND THE ILLUSTRATIONS COVERING THE SPECIFIC INSTRUMENT TO BE MOUNTED

The four anchorage methods illustrated represent load tests made to comply with California OSHPD requirements for the anchorage and installation of instrument support systems. OSHPD requires that such support systems resist a lateral force of 2 times the weight of the instrument and a vertical force of 2.2 times that weight applied simultaneously. Load tests were performed on a 10 ft. high wall using methods A, B, C and D. Forces were applied 6" above the mounting plate and 14" out from the wall on 12" support arms and 17" out on 15" support arms with diagonal braces. The maximum load rating of these instrument support systems is 80 lbs., (PolyMount VB series), and 110 lbs., (PolyMount FT series). Most instrumentation weighs well below the maximum load ratings. It is impractical to attempt to meet specific load requirements based on given weights of various instruments and the potential for changing instruments. Consequently, all installations must meet the maximum load ratings. Inspection of the anchorage by OSHPD is required prior to the installation of the mounting system. Compliance with these written instructions is required for the installation of the system.

LOCATING THE WALL CHANNEL:

Place bottom edge of a 19 inch wall CHANNEL 56 inches above the floor, plus or minus 4 inches. Taller monitors require lower channel placement. The bottom of the monitor will be 4-1/2" above the bottom of the channel, (6-1/2" when using a 15" support arm with a diagonal brace), with the ARM at its lowest position. Any control should not be higher than 72 inches above the floor. Monitors can always be adjusted UP over a 12" range in a standard 19" wall channel.

EXAMPLE: 15" high monitor: bottom of channel +52
 12" high monitor: bottom of channel +55
 7" high monitor: bottom of channel +60

Allow 14" clearance either side of the channel centerline to clear objects such as over-bed lighting, privacy curtains, adjacent walls or columns, door swing arcs, etc. Power and signal outlets should be 68 to 72 inches above the floor. Avoid oxygen, vacuum and air outlets and space for attendant flowmeters and regulators. Do not place any portion of the monitor over a patient bed. Wall channels are available in lengths of 19", 25", 31", 37", 43", and 49". Custom lengths are also available.

INSTALLING THE WALL CHANNEL:

See anchorage methods A,B,C or D. Method A is preferred as it uses readily available, standard components and allows for electrical outlets and piped services. The centerlines of methods A, B and C are critical and should be marked by the installation of a #10 sheet metal screw prior to wall cover. The 4" wide channel will cover the disruption of the gypsum board caused by the removal of this screw. Drill all screw holes in the 16 gauge anchorage using a 9/64" diameter twist drill bit for the #10 X 2" type "A", sheet metal screws supplied. Do not substitute screws.

Install the top, centerline screw first. Level the channel and mark for the remaining 9 screws. The 3 pan head screws are used in the top 3 centerline holes. All others use oval head screws. Screws should be started and driven with ball handle drivers or torque limiting screw guns not exceeding 60 inch pounds.

If there is any question as to the installation, contact GCX Corporation, Technical Services.

POLYMount® METHODS OF SUPPORT BACKING

FOR 5/8" GYPSUM BOARD WALLS TO COMPLY WITH CALIFORNIA SEISMIC REQUIREMENTS FOR WALL MOUNTED INSTRUMENTATION. CALIFORNIA OSHPD ANCHORAGE PRE-APPROVAL NUMBER R0079

ANCHORAGE OR SUPPORT OF METAL STUD WALL MUST BE VERIFIED BY THE PROJECT ENGINEER AND APPROVED BY OSHPD PRIOR TO THE INSTALLATION OF ANY MOUNTING SYSTEM.

THE MAXIMUM LOAD RATING FOR THIS SYSTEM IS 80 LBS/36Kg (VB SERIES PRODUCTS) OR 110 LBS/50Kg (FT SERIES PRODUCTS)

METHOD-A

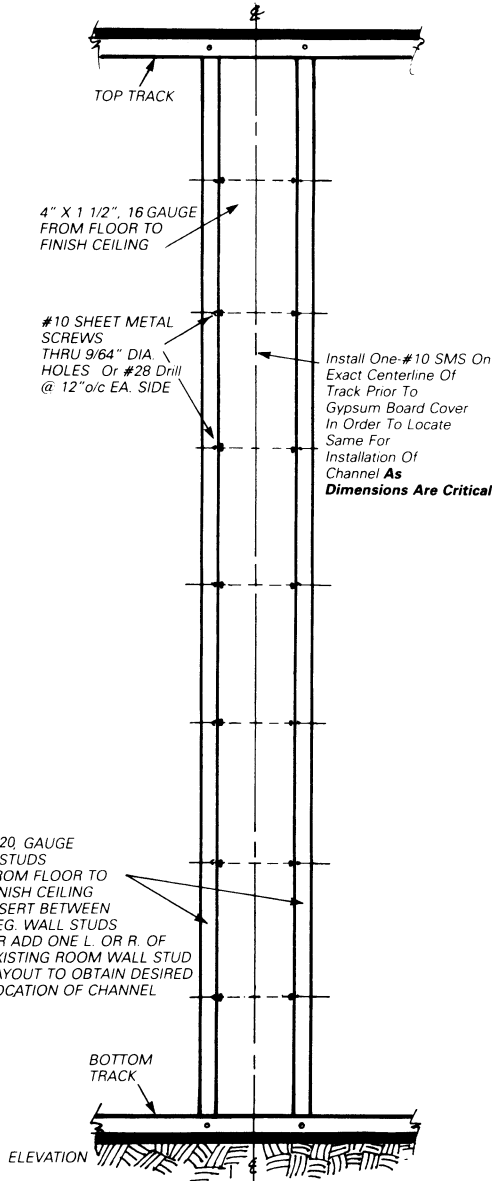
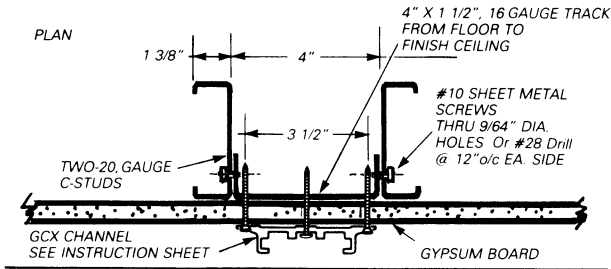

METHOD-B

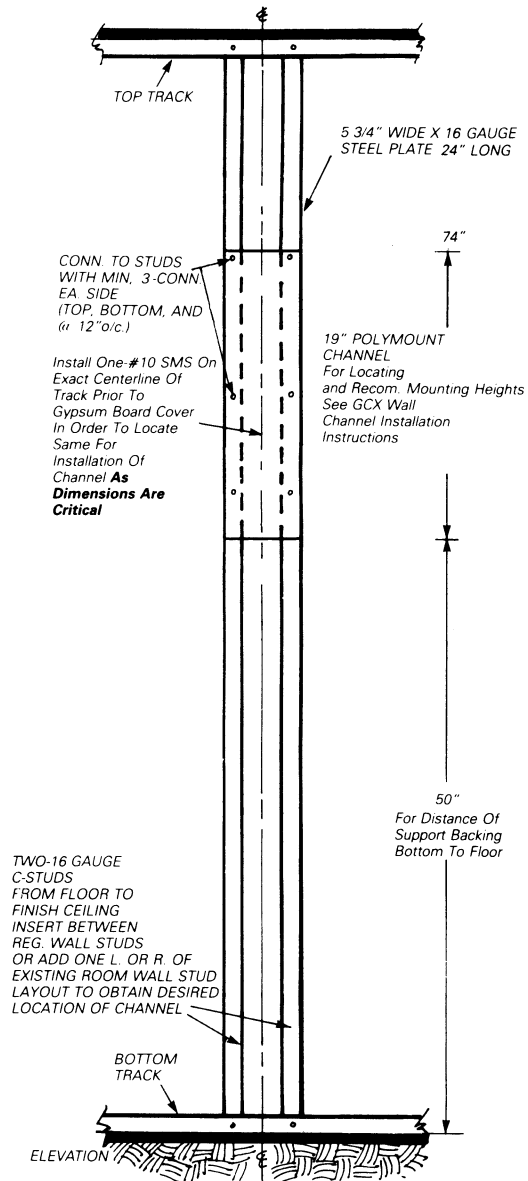
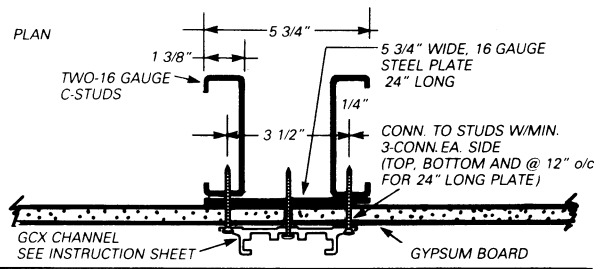

POWERMount, POLYMount and POLYQUIP ARE REGISTERED TRADEMARKS OF GCX CORPORATION

CONFIDENTIAL MATERIAL

© 1987 GCX CORPORATION ALL RIGHTS RESERVED
THIS MATERIAL IS THE PROPRIETARY INFORMATION OF GCX CORPORATION AND ANY USE, REPRODUCTION, OR DISTRIBUTION OF THE MATERIAL CONTAINED HEREIN, UNLESS SPECIFICALLY AUTHORIZED BY GCX CORPORATION, IS EXPRESSLY FORBIDDEN AND WOULD VIOLATE THE RIGHTS AND INTERESTS OF GCX CORPORATION.

COPYRIGHT © 1987 GCX CORPORATION

POLYMOUNT® METHODS OF SUPPORT BACKING

FOR 5/8" GYPSUM BOARD WALLS TO COMPLY WITH CALIFORNIA SEISMIC REQUIREMENTS

FOR WALL MOUNTED INSTRUMENTATION. CALIFORNIA OSHPD ANCHORAGE PRE-APPROVAL NUMBER R0079

ANCHORAGE OR SUPPORT OF METAL STUD WALL MUST BE VERIFIED BY THE PROJECT ENGINEER AND APPROVED BY OSHPD PRIOR TO THE INSTALLATION OF ANY MOUNTING SYSTEM.

THE MAXIMUM LOAD RATING FOR THIS SYSTEM IS 80 LBS/36Kg (VB SERIES PRODUCTS) OR 110 LBS/50Kg (FT SERIES PRODUCTS)

METHOD-C

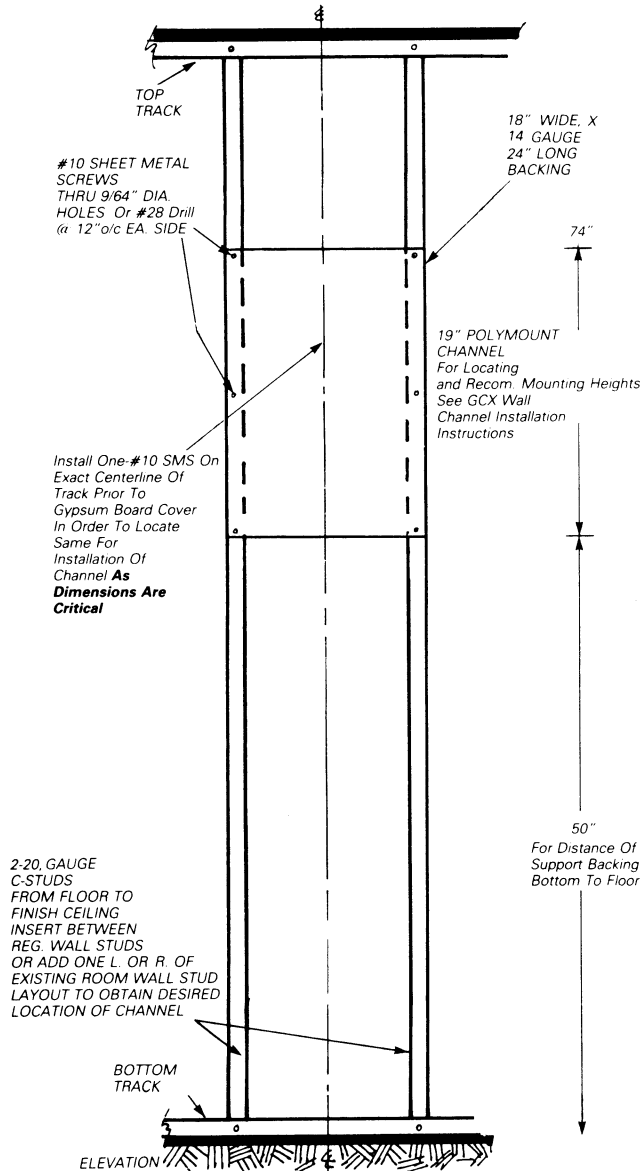
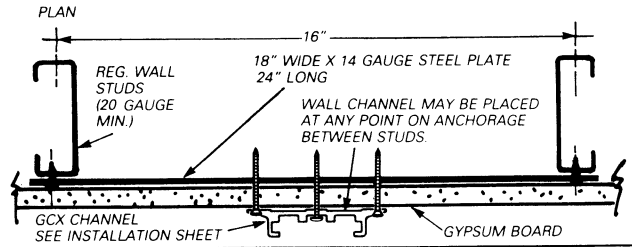

METHOD-D

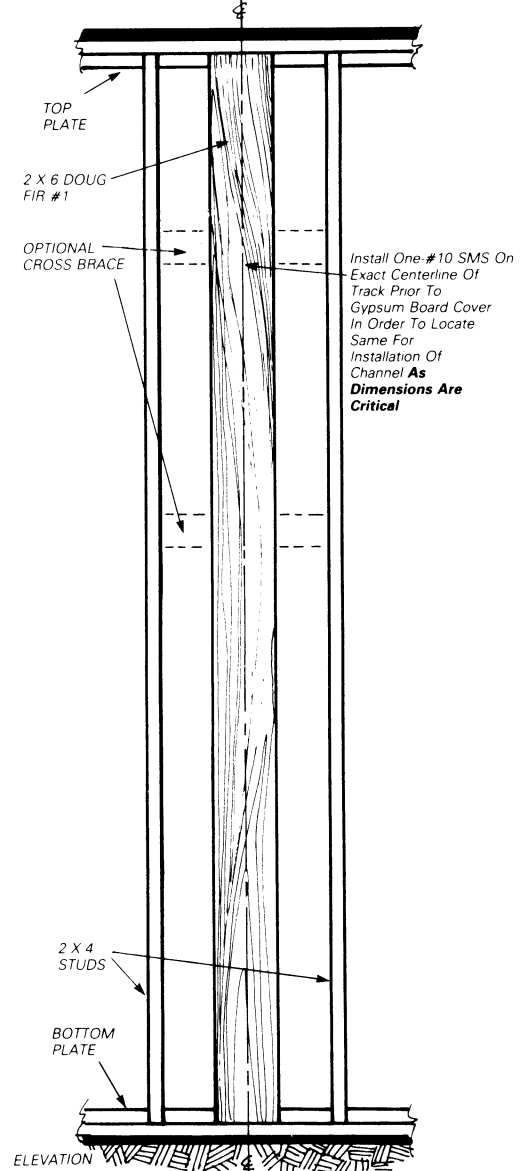
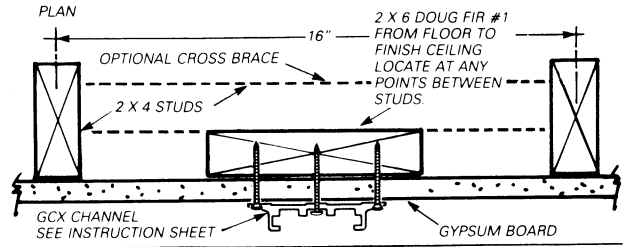

POWERMOUNT, POLYMOUNT AND POLYQUIP ARE REGISTERED TRADEMARKS OF GCX CORPORATION

COPYRIGHT © 1987 GCX CORPORATION

CONFIDENTIAL MATERIAL

© 1987 GCX CORPORATION ALL RIGHTS RESERVED
THIS MATERIAL IS THE PROPRIETARY INFORMATION OF GCX CORPORATION AND ANY USE, REPRODUCTION, OR DISTRIBUTION OF THE MATERIAL CONTAINED HEREIN, UNLESS SPECIFICALLY AUTHORIZED BY GCX CORPORATION, IS EXPRESSLY FORBIDDEN AND WOULD VIOLATE THE RIGHTS AND INTERESTS OF GCX CORPORATION.