

Installation Guide

Top Shelf Mounting Kit for Mounting Philips Intellivue MP20/30/40/50/60/70 On Dräger Fabius GS Anesthesia Machine

The purpose of this guide is to describe installation of mounting assemblies on the anesthesia machine.



WARNING: USE OF MOUNTING HARDWARE AND MONITORING COMPONENTS OTHER THAN THOSE DESCRIBED IN THIS DOCUMENT MAY RESULT IN SERIOUS INJURY DUE TO TIPPING OF THE ANESTHESIA MACHINE.

WARNING: ALL DEVICES AND MOUNTING EQUIPMENT SHOULD BE POSITIONED INWARD, CLOSE TO THE ANESTHESIA MACHINE, DURING TRANSPORT.

Installer: *When installation is completed, provide these instructions and all related documentation to the end user for future reference.*

Mounts for MP20/30/40/50/60/70

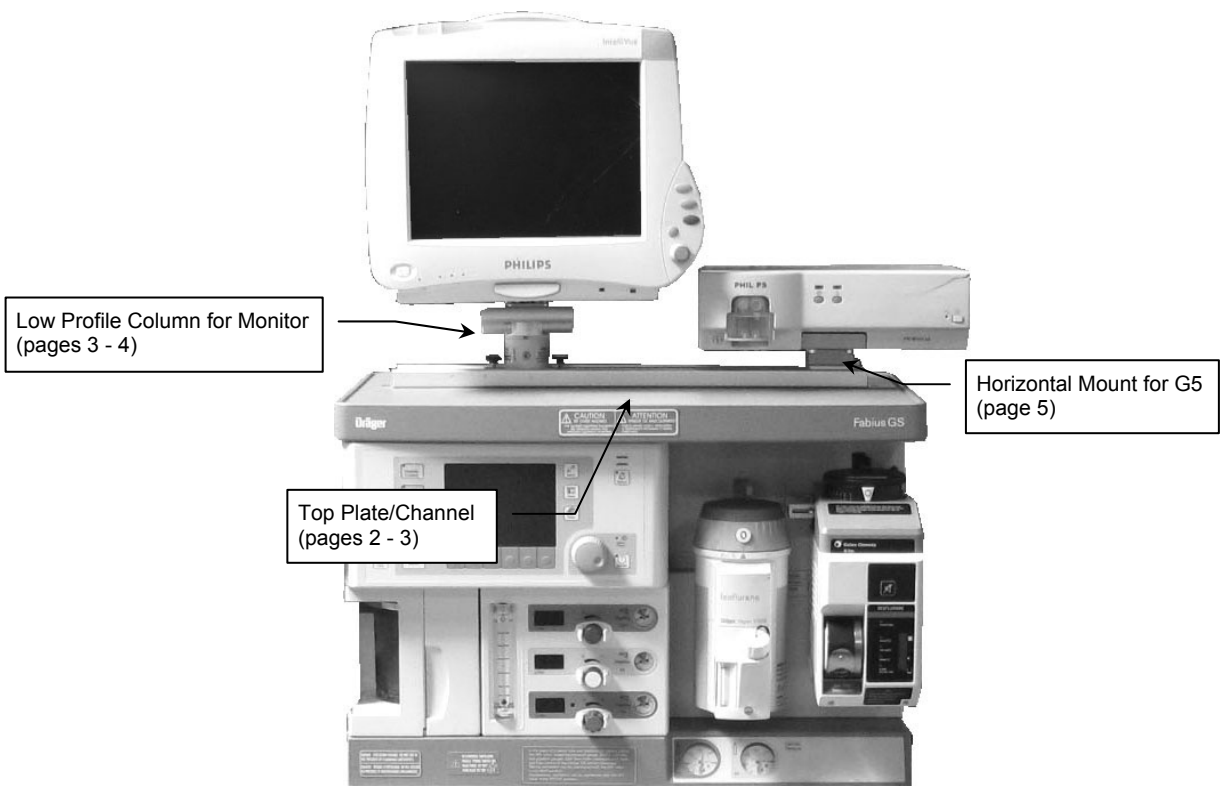

Attaching Top Plate/Channel to Top of Fabius GS

The following parts and hardware are included in this installation kit (hardware not shown):

Item #	Description	Qty
1	Top Plate with 21" Channel	1
2	M5 x 30 mm Pan Head Machine Screw (PHMS)	4
3	Label, Tip Hazard	1



Tools Required

- Drill (not provided)
- 1/4" drill bit (not provided)
- Phillips screwdriver

1. Locate four (4) dimples in top of anesthesia machine. Dimples indicate locations of threaded inserts beneath top surface. If dimples are difficult to locate, use Top Plate/Channel assembly as a template and mark top of machine through four (4) mounting holes.
2. Using a 1/4" drill bit, drill in locations marked in step 1 (drill only where dimples are present). **CAUTION:** Do not allow drill bit to penetrate more than 1/4" into top of machine. Drilling too deeply may damage threaded inserts and internal components of the machine. Remove all drilling chips.

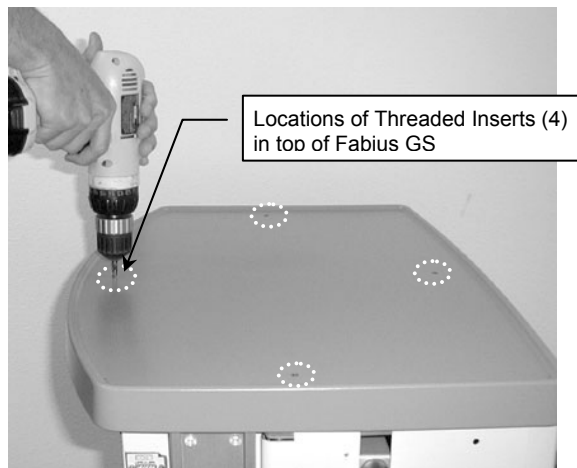

3. Align four (4) mounting holes in Top Plate with corresponding holes in top of machine (drilled in step 2). Fasten Top Plate to machine with four (4) M5 x 30mm Pan Head Machine Screws (PHMS)

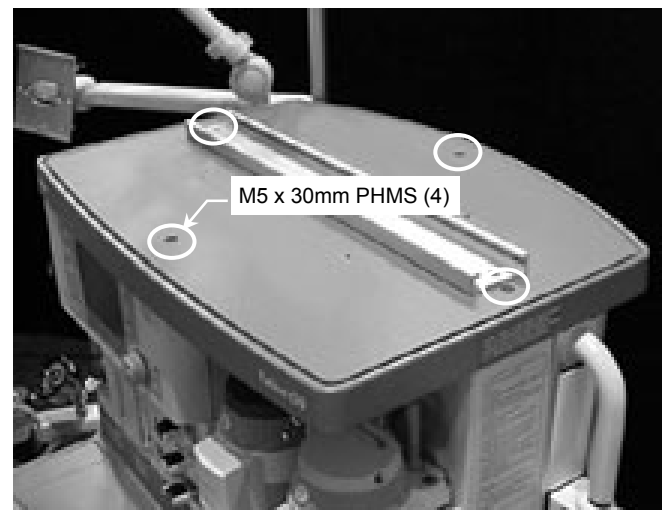

4. Attach Tip Caution Label to front center of top shelf bezel as shown below.



Mounting Low Profile Mount in Channel

The following parts and hardware are included in this installation kit (hardware not shown):

Item #	Description	Qty
1	Low Profile Column with Channel Mount	1
2	M6 x 8mm Flat Head Machine Screw (FHMS)	2
3	M6 x 12mm FHMS	1
*4	Spacer, MP20/30	1
*5	M6 x 16mm PHMS	2

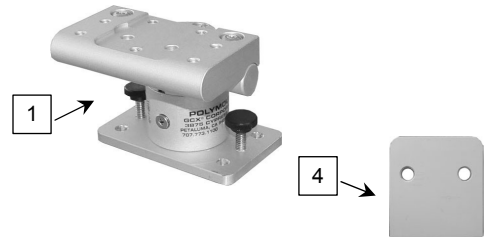

*See "MP20/30 non-Table Top Mount" on page 6 for use of these parts.

Tools Required

- Phillips screwdriver

1. Slide the Base Plate into the channel and move to desired mounting position.
2. Tighten two (2) thumb screws to secure position in channel.

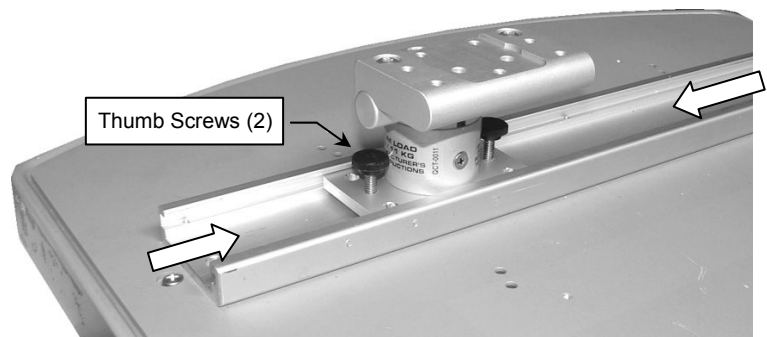

Installation Note: Do not attach the Table Top Mount to the Arm/Mounting Adapter if you will be mounting an MP20/30 monitor equipped with the mounting interface shown in photo (right). See "Mounting the Monitor on the Arm" (page 6) for instructions specific to this type of mounting plate.

Do Not Attach Table Top Mount if MP20/30 Monitor is Equipped with This Mounting Interface

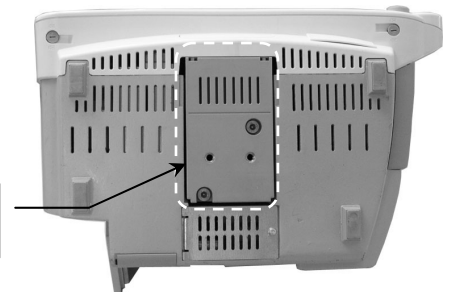

3. Fasten Table Top Mount to Mounting Adapter with one (1) M6 x 12mm FHMS and two (2) M6 x 8mm FHMS as shown

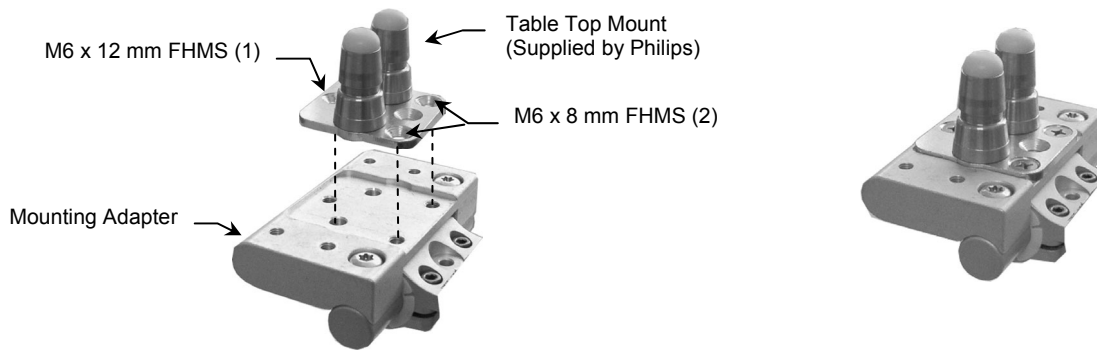

MP20/30 non-Table Top Mount

1. Fit Spacer into recessed area on top of Mounting Adapter (below). Ensure Spacer remains between Mounting Adapter and monitor.

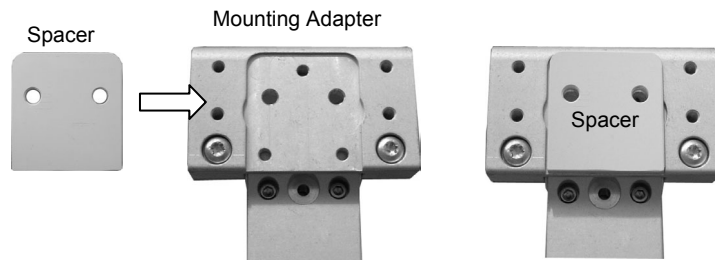

2. Insert two (2) M6 x 16mm PHMS through bottom of Mounting Adapter and thread into mounting holes in bottom of monitor.

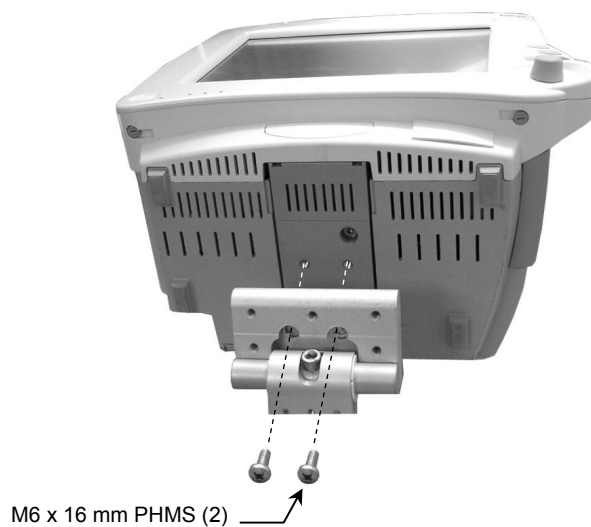

Swiveling the Mounted Instrument

Grasp the sides of the instrument and swivel to desired position. Note: Swivel is limited to $\pm 20^\circ$ on this Mount.

Adjusting Tilt and Tilt Tension

Tilt: Grasp the top and bottom of the instrument and tilt it to desired angle.

Tilt Tension: Using the 5/32" hex wrench provided, equally tighten or loosen the two (2) Tilt Tension Screws.

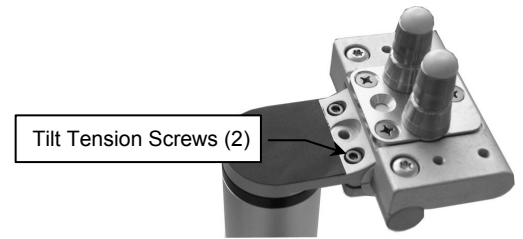

Mounting Horizontal Mount in Channel

The following parts and hardware are included in this installation kit (hardware not shown):

Item #	Description	Qty
1	Horizontal Channel Mount	1
2	M6 x 10mm Flat Head Machine Screw (FHMS)	3

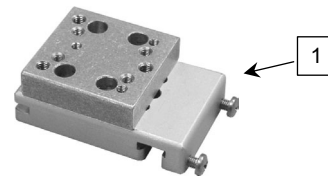

Tools Required

- Phillips screwdriver

1. Fasten the Philips-supplied Table Top Mount to the Mounting Adapter with three (3) M6 x 10mm PHMS as shown below.

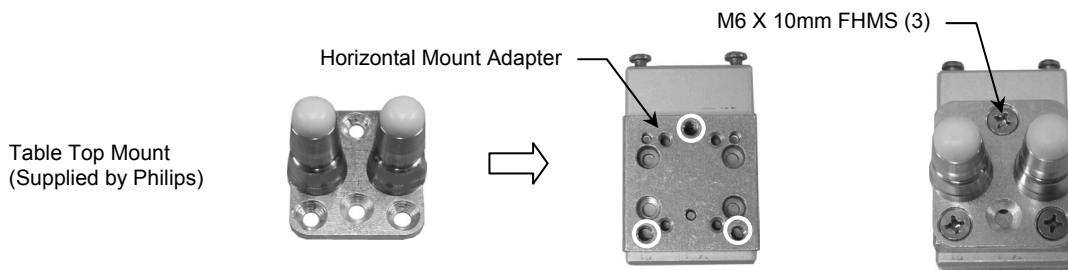

2. With two (2) set screws oriented toward rear of application, slide Horizontal Mount into Channel and move Mount to desired instrument-mounting position (example below left).
3. Tighten two (2) Phillips-head set screws at rear of Horizontal Mount to prevent movement of Mount (below right). See page 5 for photo of Horizontal Channel Mount installed on top of Fabius GS.

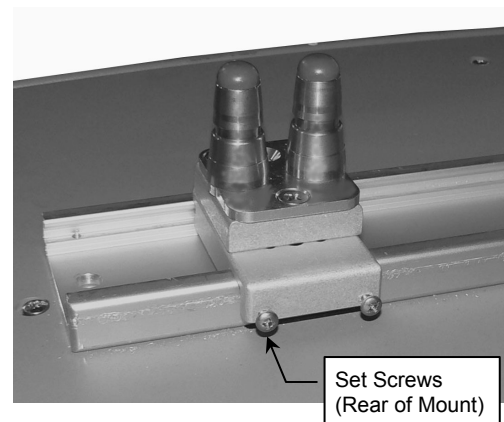
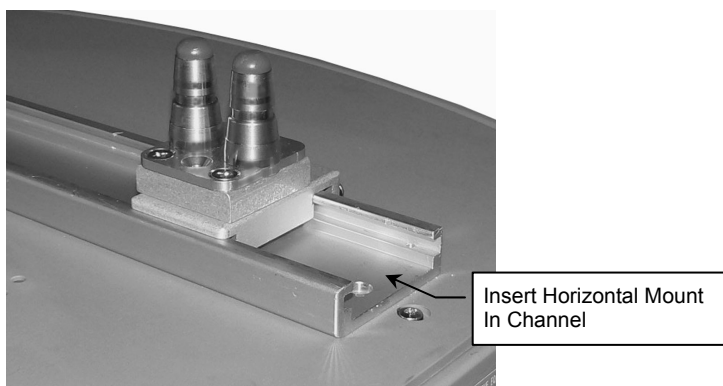

Periodic Maintenance

All fasteners associated with the mounting system should be inspected periodically and tightened or adjusted as necessary for optimal operation and safety.

Cleaning the Mounting Assembly

CAUTION: GCX makes no claims regarding the efficacy of the listed chemicals or processes as a means for controlling infection. Consult your hospital's infection control officer or epidemiologist. To clean or sterilize mounted devices or accessory equipment, refer to the specific instructions delivered with those products.

1. The mounting assembly may be cleaned with most mild, non-abrasive solutions commonly used in the hospital environment (e.g. diluted bleach, ammonia, or alcohol solutions).
2. The surface finish will be permanently damaged by strong chemicals and solvents such as acetone or trichloroethylene.
3. Steel wool or other abrasive material should never be used.
4. Damage caused by the use of unapproved substances or processes will not be warranted. We recommend testing of any cleaning solution on a small area of the arm that is not visible to verify compatibility.
5. Never submerge or allow liquids to enter the arm. Wipe any cleaning agents off the arm immediately using a water-dampened cloth. Dry mounting assembly thoroughly after cleaning.