

Installation Guide

Articulating Arm for Mounting Philips IntelliVue MP5/20/30/40/50/60/70, MX400/450/500/550/600/700/800
on Dräger Apollo Left Side



The purpose of this guide is to describe mounting of Arm and related parts on left side of machine.



WARNING: USE OF MOUNTING HARDWARE AND MONITORING COMPONENTS OTHER THAN THOSE DESCRIBED IN THIS DOCUMENT MAY RESULT IN SERIOUS INJURY DUE TO TIPPING OF THE ANESTHESIA MACHINE.



WARNING: ALL DEVICES AND MOUNTING EQUIPMENT SHOULD BE POSITIONED INWARD, CLOSE TO THE APOLLO, DURING TRANSPORT.

Installer: When installation is completed, provide these instructions and all related documentation to the end user for future reference.

Parts Reference

The following parts and hardware are included in this installation kit (hardware not shown):

Item #	Description	Qty
1	M-series Articulating Arm	1
2	Nut Plate	2
3	M6 x 22mm Flat Head Socket Cap Screw (FHSCS)	2
4	M6 x 8mm Flat Head Machine Screw (FHMS)	1
5	M6 x 12mm FHMS	2
6	Down Post, 6"	1
7	#10-32 x 3/8" Socket Head Cap Screw (SHCS)	3
8	5/32" Hex Wrench	1
9*	Spacer	1
10*	M6 x 16mm Pan Head Machine Screw (PHMS)	2

*See "Non-Table Mount" on p.4 for use of these parts.

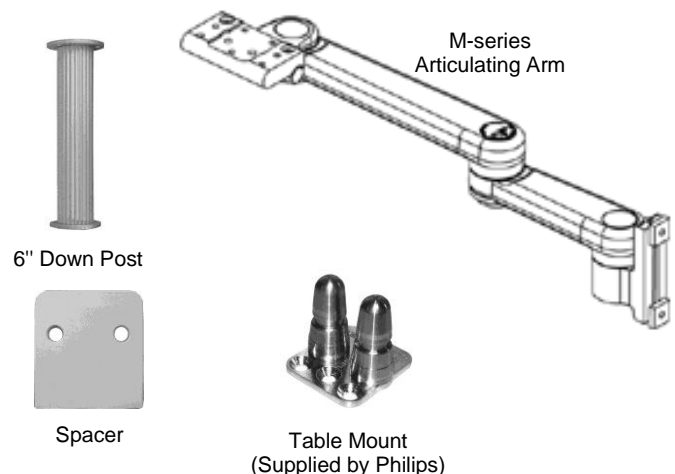

Tools Required: 5/32" hex wrench (provided), Phillips screwdriver (not provided), 1/2" socket wrench (not provided).

Attaching Down Post to M-Series Arm

1. Remove plastic bolt cap from bottom of Swivel Cup (not shown).
2. Using the 5/32" hex wrench provided, fasten Post to Swivel Cup with three (3) #10-32 x 3/8" SHCS as shown below.

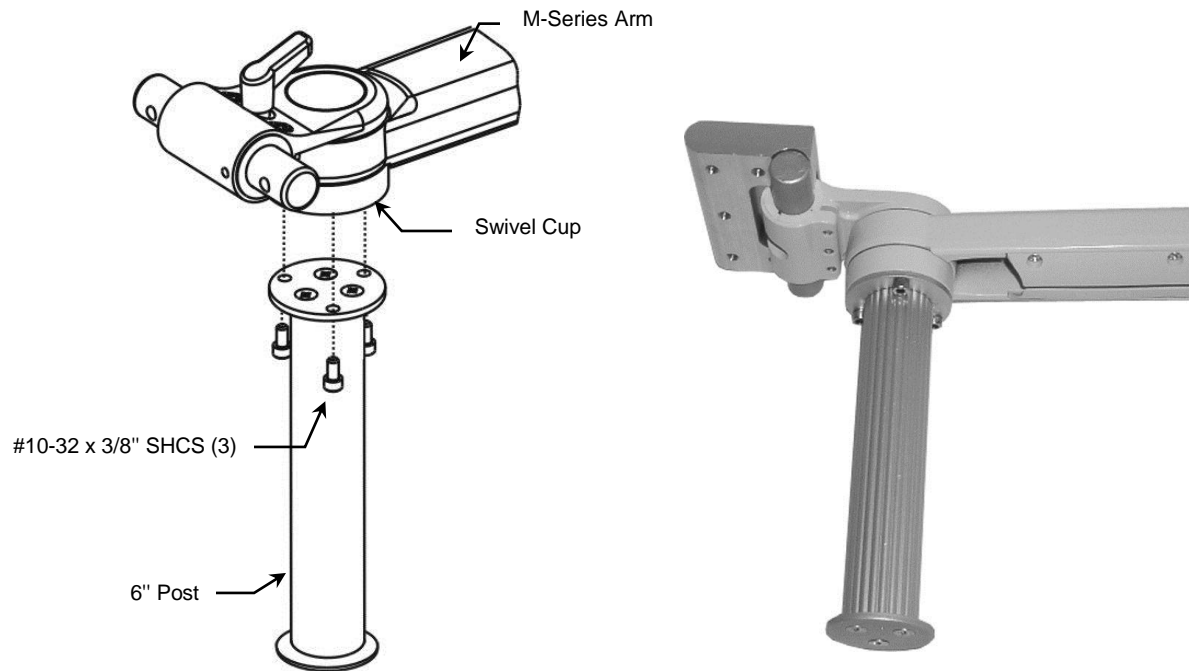

Mounting Arm in Left Side Accessory Track

1. Thread one (1) M6 x 22mm FHSCS a few turns into each Nut Plate, leaving 15 mm of thread exposed per screw (right).
2. Insert Nut Plate/screw assemblies in top and bottom slots, holding bottom screw in place to prevent it from falling out of slot (right).
3. While holding bottom Nut Plate in position (below left), guide both Nut Plates into track and move entire assembly up track to desired mounting position.
4. Using the 5/32" hex wrench provided, tighten bottom screw first, then top screw (below right).

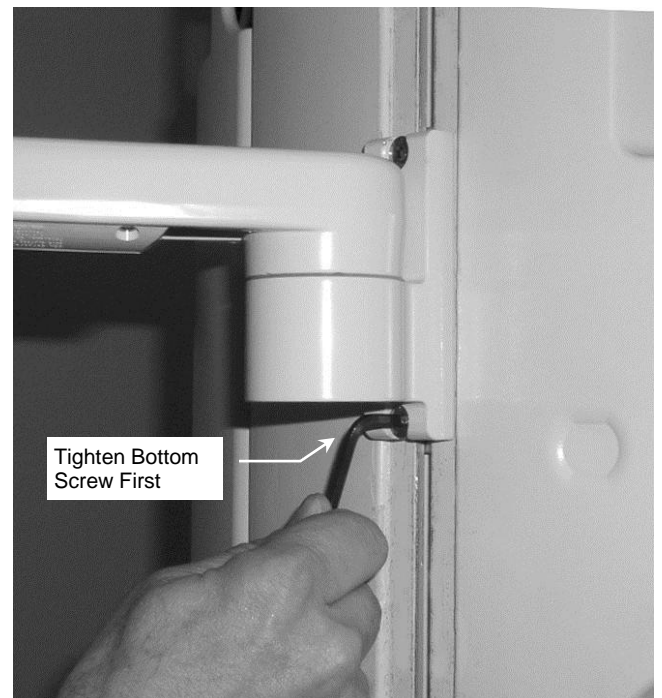
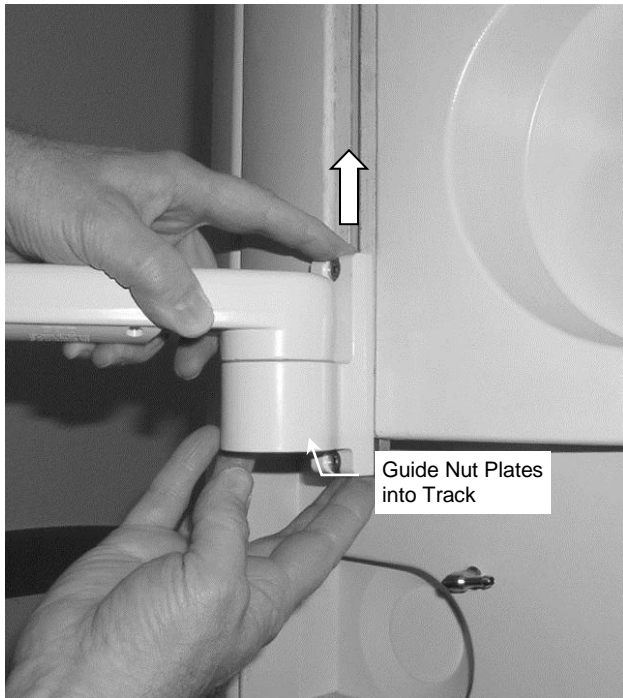
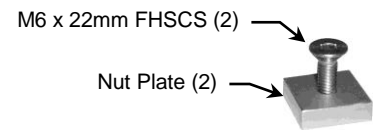

Positioning Arm in Track



WARNING: Do not attempt to remove the Arm from the track while an instrument is mounted.

While *supporting the weight of the mounted instrument, loosen the two (2) flat head socket cap screws (FHSCS) in the Slide. A 5/32" hex wrench is provided for this task. Push up or pull down at the end of the arm nearest the Slide. Tighten screws to secure Arm in track.

* It may be necessary to dismount instrument before adjusting Arm in track.

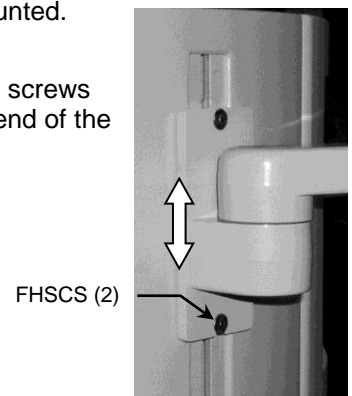

Attaching Philips Table Mount to Mounting Adapter

Installation Note: Do not attach the Table Mount to the Arm/Mounting Adapter if you will be mounting a monitor equipped with the mounting interface shown in photo (right). See "Non-Table Mount" (bottom of page) for instructions specific to this type of mounting plate

Do not attach Table Mount if monitor is equipped with this mounting interface.

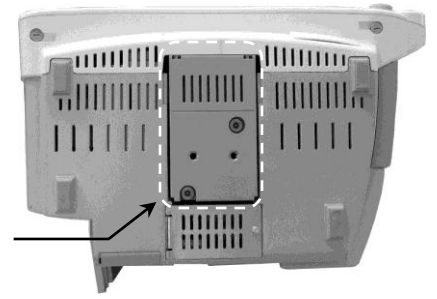

1. Fasten Philips-supplied Table Mount to Mounting Adapter on the Arm with one (1) M6 x 12mm FHMS and two (2) M6 x 8mm FHMS as shown below.

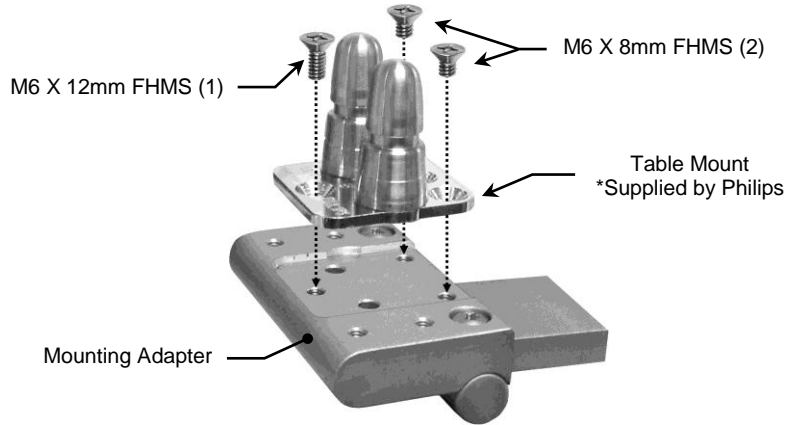

2. Mount monitor in accordance with Philips Table Mount instructions or follow procedure below for Non-Table Mount or the MX400/450/500/550 Fixed Mount Adapter (PH-0073-15).

Non-Table Mount

1. Fit Spacer into recessed area on top of Mounting Adapter (below). Ensure Spacer remains between Mounting Adapter and monitor.
2. Insert two (2) M6 x 16mm PHMS through bottom of Mounting Adapter and thread into mounting holes in bottom of monitor (right).

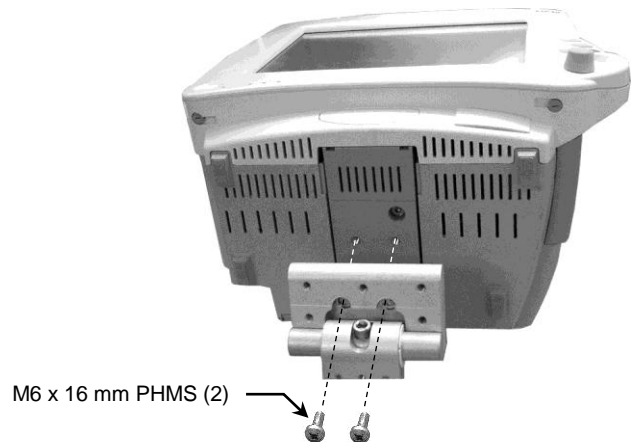
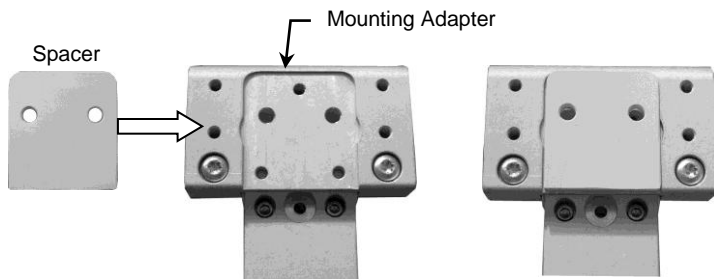

Mounting the MX400/450/500/550 Monitor (Fixed Mount Adapter)

Mount the monitor in accordance with separate Installation Guide DU-PH-0073-15 provided with the Mounting Adapter, ordered separately.

M-Series Arm Operation and Adjustment

Refer to Installation Guide provided with the M-Series Articulating Arm (*DU-WMM-0001*).

Routine Maintenance

Periodically check all mounting hardware. Tighten as necessary for optimal operation.

Cleaning the Mounting Assembly

CAUTION: GCX makes no claims regarding the efficacy of the listed chemicals or processes as a means for controlling infection. Consult your hospital's infection control officer or epidemiologist. To clean or sterilize mounted instruments or accessory equipment, refer to the specific instructions delivered with those products.

1. The mounting assembly may be cleaned with most mild, non-abrasive solutions commonly used in the hospital environment (e.g. diluted bleach, ammonia, or alcohol solutions).
2. The surface finish will be permanently damaged by strong chemicals and solvents such as acetone and trichloroethylene.
3. Do not use steel wool or other abrasive material to clean the mounting assembly.
4. Damage caused by the use of unapproved substances or processes will not be covered by warranty. We recommended that you test any cleaning solution on a small area of the arm that is not visible to verify compatibility.
5. Never submerge or allow liquids to enter the arm. Wipe any cleaning agents off of the arm immediately, using a water-dampened cloth. Dry the arm thoroughly after cleaning.